

FEATURES

64-position

OTP (one-time programmable)¹ set-and-forget resistance setting — low cost alternative over EEMEM

Unlimited adjustments prior to OTP activation

5 k Ω , 10 k Ω , 50 k Ω , 100 k Ω end-to-end resistance

Low tempco 5 ppm/ $^{\circ}$ C in potentiometer mode

Low tempco 35 ppm/ $^{\circ}$ C in rheostat mode

Compact standard SOT-23-8 package

Low power, I_{DD} = 10 μ A max

Fast settling time, t_s = 5 μ s typ in power-up

I²C[®] compatible digital interface

Computer software replaces μ C in factory programming applications

Full read/write of wiper register

Extra I²C device address pin

Power-on preset to midscale

5.5 V one-time programming voltage

Low operating voltage, 2.7 V to 5.5 V

OTP validation check function

Automotive temperature range -40 $^{\circ}$ C to +125 $^{\circ}$ C

APPLICATIONS

Systems calibrations

Electronics level settings

Mechanical Trimmers[®] and potentiometer replacements

Automotive electronics adjustments

Gain control and offset adjustments

Transducer circuits adjustments

Programmable filters up to 1.5 MHz BW

GENERAL DESCRIPTION

The AD5171 is a 64-position, one-time programmable (OTP) digital potentiometer² that uses fuse link technology to achieve the memory retention of the resistance setting function. OTP is a cost-effective alternative over the EEMEM approach for users who do not need to reprogram new memory settings in the digital potentiometer. This device performs the same electronic adjustment function as most mechanical trimmers and variable resistors. The AD5171 is programmed using a 2-wire I²C compatible digital control. It allows unlimited adjustments before permanently setting the resistance value. During the OTP activation, a permanent fuse blown command is sent after the final value is determined freezing the wiper position at a given setting (analogous to placing epoxy on a mechanical

trimmer). When this permanent setting is achieved, the value does not change regardless of supply variations or environmental stresses under normal operating conditions. To verify the success of permanent programming, Analog Devices patterned the OTP validation such that the fuse status can be discerned from two validation bits in read mode.

For applications that program the AD5171 in factories, Analog Devices offers device programming software that operates across Windows[®] 95 to XP platforms, including Windows NT. This software application effectively replaces the need for external I²C controllers or host processors and therefore significantly reduces users' development time.

An AD5171 evaluation kit is available, which includes the software, connector, and cable that can be converted for factory programming applications.

The AD5171 is available in a compact SOT-23-8 package. All parts are guaranteed to operate over the automotive temperature range of -40 $^{\circ}$ C to +125 $^{\circ}$ C. Besides its unique OTP feature, the AD5171 lends itself well to other general-purpose digital potentiometer applications due to its temperature performance, small form factor, and low cost.

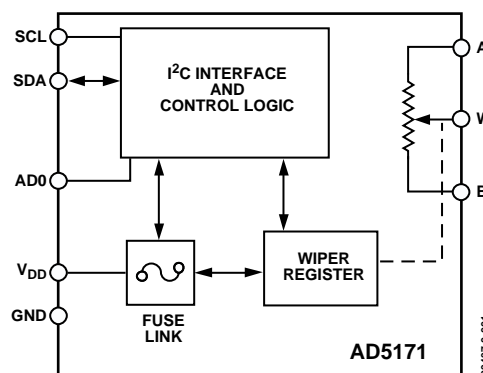

Figure 1. Functional Block Diagram

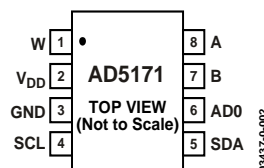

Figure 2. Pin Configuration

¹ One-time programmable (OTP)—unlimited adjustments before permanent setting.

² The terms digital potentiometer and RDAC are used interchangeably.

Rev. A

Information furnished by Analog Devices is believed to be accurate and reliable. However, no responsibility is assumed by Analog Devices for its use, nor for any infringements of patents or other rights of third parties that may result from its use. Specifications subject to change without notice. No license is granted by implication or otherwise under any patent or patent rights of Analog Devices. Trademarks and registered trademarks are the property of their respective owners.

TABLE OF CONTENTS

Electrical Characteristics	3	I ² C Controller Programming.....	16
Absolute Maximum Ratings.....	5	I ² C Compatible 2-Wire Serial Bus	17
ESD Caution.....	5	Controlling Two Devices on One Bus	17
Pin Configuration and Functional Descriptions.....	6	Applications.....	18
Typical Performance Characteristics	7	DAC.....	18
Theory of Operation	11	Gain Control Compensation	18
One-Time Programming (OTP)	11	Programmable Voltage Source with Boosted Output	18
Power Supply Considerations	11	Level Shifting for Different Voltage Operation	18
ESD Protection	12	Resistance Scaling	18
Terminal Voltage Operating Range.....	12	Resolution Enhancement	19
Power-Up/Power-Down Sequences.....	12	RDAC Circuit Simulation Model.....	19
Determining the Variable Resistance and Voltage.....	13	AD5171 Evaluation Board	20
Rheostat Mode Operation.....	13	Outline Dimensions	21
Potentiometer Mode Operation	13	Ordering Guide	21
Controlling the AD5171	14		
Software Programming	14		

REVISION HISTORY**11/04—Changed Data Sheet from Rev. 0 to Rev. A**

Changes to Specifications	3
Changes to Table 3.....	7
Changes to One-Time Programming section.....	11
Changes to Power Supply Consideration section.....	11
Changes to Figure 26 and Figure 27.....	12

1/04—Revision 0: Initial Version

ELECTRICAL CHARACTERISTICS

5 k Ω , 10 k Ω , 50 k Ω , and 100 k Ω versions; $V_{DD} = 3\text{ V to }5\text{ V} \pm 10\%$, $V_A = V_{DD}$, $V_B = 0\text{ V}$, $-40^\circ\text{C} < T_A < +125^\circ\text{C}$, unless otherwise noted.

Table 1.

Parameter	Symbol	Conditions	Min	Typ ¹	Max	Unit
DC CHARACTERISTICS RHEOSTAT MODE						
Resistor Differential Nonlinearity ²	R-DNL	R_{WB} , $V_A = \text{no connect}$, $R_{AB} = 10\text{ k}\Omega$, $50\text{ k}\Omega$, and $100\text{ k}\Omega$	-0.5	± 0.1	+0.5	LSB
Resistor Integral Nonlinearity ²	R-INL	R_{WB} , $V_A = \text{no connect}$, $R_{AB} = 5\text{ k}\Omega$ R_{WB} , $V_A = \text{no connect}$, $R_{AB} = 10\text{ k}\Omega$, $50\text{ k}\Omega$, and $100\text{ k}\Omega$ R_{WB} , $V_A = \text{no connect}$, $R_{AB} = 5\text{ k}\Omega$	-1 -1.5	± 0.25 ± 0.35	+1 +1.5	LSB LSB
Nominal Resistor Tolerance ³	$\Delta R_{AB}/R_{AB}$		-30		+30	%
Resistance Temperature Coefficient	$(\Delta R_{AB}/R_{AB})/\Delta T$			35		ppm/ $^\circ\text{C}$
Wiper Resistance	R_W	$V_{DD} = 5\text{ V}$		60	115	Ω
DC CHARACTERISTICS POTENTIOMETER DIVIDER MODE (Specifications apply to all RDACs)						
Resolution	N				6	Bits
Differential Nonlinearity ⁴	DNL		-0.5	± 0.1	+0.5	LSB
Integral Nonlinearity ⁴	INL		-1	± 0.2	+1	LSB
Voltage Divider Temperature Coefficient	$(\Delta V_W/V_W)/\Delta T$	Code = 0x20		5		ppm/ $^\circ\text{C}$
Full-Scale Error	V_{WFSE}	Code = 0x3F, $R_{AB} = 10\text{ k}\Omega$, $50\text{ k}\Omega$, and $100\text{ k}\Omega$	-1	-0.5	0	LSB
Full-Scale Error	V_{WFSE}	Code = 0x3F, $R_{AB} = 5\text{ k}\Omega$	-1.5		0	LSB
Zero-Scale Error	V_{WZSE}	Code = 0x00, $R_{AB} = 10\text{ k}\Omega$, $50\text{ k}\Omega$, and $100\text{ k}\Omega$	0	0.5	1	LSB
		Code = 0x00, $R_{AB} = 5\text{ k}\Omega$	0		2	LSB
RESISTOR TERMINALS						
Voltage Range ⁵	$V_{A,B,W}$	With respect to GND			V_{DD}	V
Capacitance ⁶ A, B	$C_{A,B}$	$f = 1\text{ MHz}$, measured to GND, Code = 0x20		25		pF
Capacitance ⁶ W	C_W	$f = 1\text{ MHz}$, measured to GND, Code = 0x20		55		pF
Common-Mode Leakage	I_{CM}	$V_A = V_B = V_{DD}/2$		1		nA
DIGITAL INPUTS						
Input Logic High (SDA and SCL)	V_{IH}		$0.7 V_{DD}$		$V_{DD} + 0.5$	V
Input Logic Low (SDA and SCL)	V_{IL}		-0.5		$0.3 V_{DD}$	V
Input Logic High (AD0)	V_{IH}	$V_{DD} = 3\text{ V}$	3.0		V_{DD}	V
Input Logic Low (AD0)	V_{IL}	$V_{DD} = 3\text{ V}$	0		1.0	V
Input Current	I_{IL}	$V_{IN} = 0\text{ V or }5\text{ V}$			± 1	μA
Input Capacitance ⁶	C_{IL}			3		pF
DIGITAL OUTPUTS						
Output Logic Low (SDA)	V_{OL}	$I_{OL} = 6\text{ mA}$			0.4	V
Three-State Leakage Current (SDA)	I_{OZ}	$V_{IN} = 0\text{ V or }5\text{ V}$			± 1	μA
Output Capacitance ⁶	C_{OZ}			3		pF
POWER SUPPLIES						
Power Supply Range	V_{DD}		2.7		5.5	V
OTP Power Supply ⁷	V_{DD_OTP}	$T_A = 25^\circ\text{C}$	5.25		5.5	V
Supply Current	I_{DD}	$V_{IH} = 5\text{ V or }V_{IL} = 0\text{ V}$		4	10	μA
OTP Supply Current ⁸	I_{DD_OTP}	$V_{DD_OTP} = 5.5\text{ V}$, $T_A = 25^\circ\text{C}$	100			mA
Power Dissipation ⁹	P_{DISS}	$V_{IH} = 5\text{ V or }V_{IL} = 0\text{ V}$, $V_{DD} = 5\text{ V}$		0.02	0.04	mW
Power Supply Sensitivity	PSSR		-0.025	+0.001	+0.025	%/%

AD5171

Parameter	Symbol	Conditions	Min	Typ ¹	Max	Unit
DYNAMIC CHARACTERISTICS^{6, 10, 11}						
Bandwidth –3 dB	BW_5k	$R_{AB} = 5 \text{ k}\Omega$, Code = 0x20		1500		kHz
	BW_10k	$R_{AB} = 10 \text{ k}\Omega$, Code = 0x20		600		kHz
	BW_50k	$R_{AB} = 50 \text{ k}\Omega$, Code = 0x20		110		kHz
	BW_100k	$R_{AB} = 100 \text{ k}\Omega$, Code = 0x20		60		kHz
Total Harmonic Distortion	THD	$V_A = 1 \text{ V rms}$, $R_{AB} = 10 \text{ k}\Omega$, $V_B = 0 \text{ V DC}$, $f = 1 \text{ kHz}$		0.05		%
Adjustment Settling Time	t_{S1}	$V_A = 5 \text{ V} \pm 1 \text{ LSB error band}$, $V_B = 0 \text{ V}$, measured at V_W		5		μs
OTP Settling Time ¹²	t_{S_OTP}	$V_A = 5 \text{ V} \pm 1 \text{ LSB error band}$, $V_B = 0 \text{ V}$, measured at V_W		400		ms
Power-Up Settling Time—Post Fuses Blown	t_{S2}	$V_A = 5 \text{ V} \pm 1 \text{ LSB error band}$, $V_B = 0 \text{ V}$, measured at V_W		5		μs
Resistor Noise Voltage	e_{N_WB}	$R_{AB} = 5 \text{ k}\Omega$, $f = 1 \text{ kHz}$, Code = 0x20		8		$\text{nV}/\sqrt{\text{Hz}}$
		$R_{AB} = 10 \text{ k}\Omega$, $f = 1 \text{ kHz}$, Code = 0x20		12		$\text{nV}/\sqrt{\text{Hz}}$
INTERFACE TIMING CHARACTERISTICS (Apply to all parts ^{6, 12})						
SCL Clock Frequency	f_{SCL}				400	kHz
t_{BUF} Bus Free Time between Start and Stop	t_1	After this period, the first clock pulse is generated.	1.3			μs
$t_{HD,STA}$ Hold Time (Repeated Start)	t_2		0.6			μs
t_{LOW} Low Period of SCL Clock	t_3		1.3			μs
t_{HIGH} High Period of SCL Clock	t_4		0.6		50	μs
$t_{SU,STA}$ Setup Time for Start Condition	t_5		0.6			μs
$t_{HD,DAT}$ Data Hold Time	t_6				0.9	μs
$t_{SU,DAT}$ Data Setup Time	t_7		0.1			μs
t_F Fall Time of Both SDA and SCL Signals	t_8				0.3	μs
t_R Rise Time of Both SDA and SCL Signals	t_9				0.3	μs
$t_{SU,STO}$ Setup Time for Stop Condition	t_{10}			0.6		μs

¹ Typical specifications represent average readings at 25°C and $V_{DD} = 5 \text{ V}$.

² Resistor position nonlinearity error R-INL is the deviation from an ideal value measured between the maximum resistance and the minimum resistance wiper positions. R-DNL measures the relative step change from ideal between successive tap positions. Parts are guaranteed monotonic.

³ $V_{AB} = V_{DD}$, Wiper (V_W) = no connect.

⁴ INL and DNL are measured at V_W with the RDAC configured as a potentiometer divider similar to a voltage output DAC. $V_A = V_{DD}$ and $V_B = 0 \text{ V}$. DNL specification limits of $\pm 1 \text{ LSB}$ maximum are guaranteed monotonic operating conditions.

⁵ Resistor terminals A, B, W have no limitations on polarity with respect to each other.

⁶ Guaranteed by design and not subject to production test.

⁷ Different from operating power supply, power supply for OTP is used one-time only.

⁸ Different from operating current, supply current for OTP lasts approximately 400 ms for one-time needed only.

⁹ P_{DISS} is calculated from $(I_{DD} \times V_{DD})$. CMOS logic level inputs result in minimum power dissipation.

¹⁰ Bandwidth, noise, and settling time are dependent on the terminal resistance value chosen. The lowest R value results in the fastest settling time and highest bandwidth. The highest R value results in the minimum overall power consumption.

¹¹ All dynamic characteristics use $V_{DD} = 5 \text{ V}$.

¹² Different from settling time after fuse is blown. The OTP settling time occurs only once.

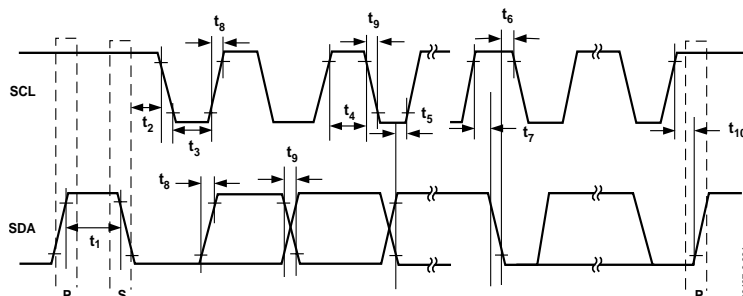

Figure 3. Interface Timing Diagram

ABSOLUTE MAXIMUM RATINGS

Table 2.

Parameter	Rating
V_{DD} to GND	-0.3, +7 V
V_A , V_B , V_W to GND	GND, V_{DD}
Maximum Current	
I_{WB} , I_{WA} Pulsed	± 20 mA
I_{WB} Continuous ($R_{WB} \leq 1$ k Ω , A open) ¹	± 5 mA
I_{WA} Continuous ($R_{WA} \leq 1$ k Ω , B open) ¹	± 5 mA
Digital Inputs and Output Voltage to GND	0 V, V_{DD}
Operating Temperature Range	-40°C to +125°C
Maximum Junction Temperature (T_J max)	150°C
Storage Temperature	-65°C to +150°C
Lead Temperature (Soldering, 10 sec)	300°C
Vapor Phase (60 sec)	215°C
Infrared (15 sec)	220°C
Thermal Resistance ² θ_{JA}	230°C/W

¹ Maximum terminal current is bounded by the maximum applied voltage across any two of the A, B, and W terminals at a given resistance, the maximum current handling of the switches, and the maximum power dissipation of the package. $V_{DD} = 5$ V.

² Package power dissipation = $(T_J \text{ max} - T_A)/\theta_{JA}$.

Stresses above those listed under Absolute Maximum Ratings may cause permanent damage to the device. This is a stress rating only and functional operation of the device at these or any other conditions above those indicated in the operational section of this specification is not implied. Exposure to absolute maximum rating conditions for extended periods may affect device reliability.

ESD CAUTION

ESD (electrostatic discharge) sensitive device. Electrostatic charges as high as 4000 V readily accumulate on the human body and test equipment and can discharge without detection. Although this product features proprietary ESD protection circuitry, permanent damage may occur on devices subjected to high energy electrostatic discharges. Therefore, proper ESD precautions are recommended to avoid performance degradation or loss of functionality.



PIN CONFIGURATION AND FUNCTIONAL DESCRIPTIONS

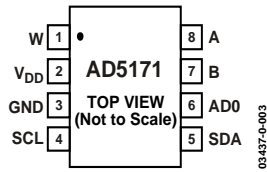

Figure 4. Pin Configuration

Table 3. Pin Function Descriptions

Pin No.	Mnemonic	Description
1	W	Wiper Terminal W. $GND \leq V_W \leq V_{DD}$.
2	V_{DD}	Positive Power Supply. Specified for operation from 2.7 V to 5.5 V. For OTP programming, V_{DD} needs to be a minimum of 5.5 V and 100 mA driving capability.
3	GND	Common Ground.
4	SCL	Serial Clock Input. Requires pull-up resistor.
5	SDA	Serial Data Input/Output. Requires pull-up resistor.
6	AD0	I ² C Device Address Bit. Allows maximum of two AD5171s to be addressed.
7	B	Resistor Terminal B. $GND \leq V_B \leq V_{DD}$.
8	A	Resistor Terminal A. $GND \leq V_A \leq V_{DD}$.

TYPICAL PERFORMANCE CHARACTERISTICS

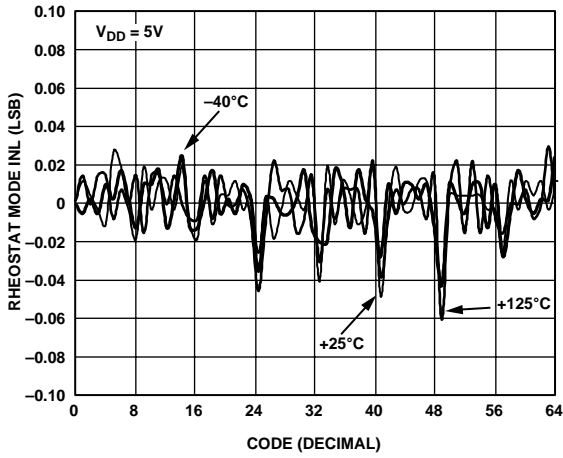

Figure 5. R-INL vs. Code vs. Temperature

03437-0-004

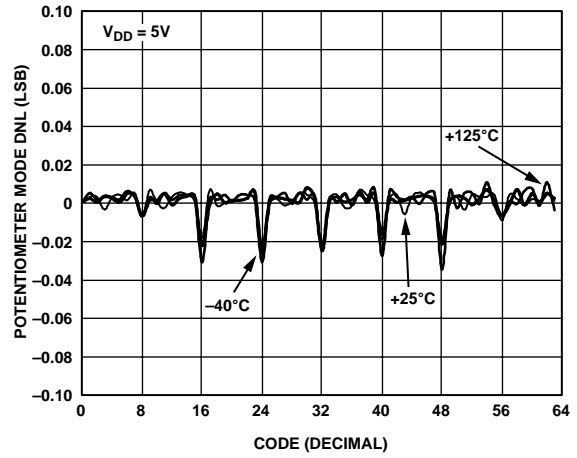

Figure 8. DNL vs. Code vs. Temperature

03437-0-007

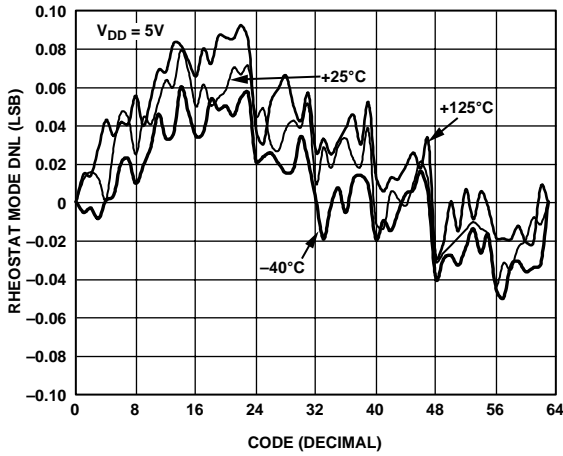

Figure 6. R-DNL vs. Code vs. Temperature

03437-0-005

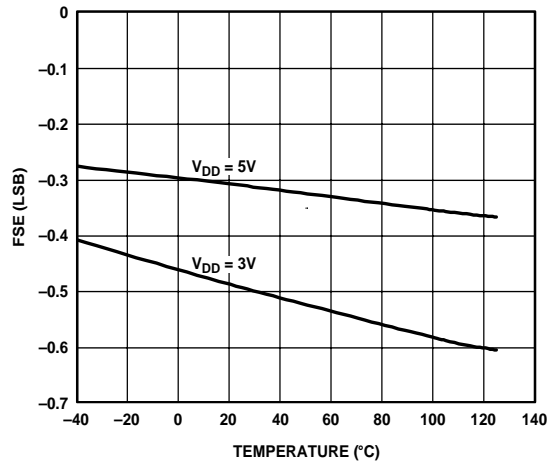

Figure 9. Full-Scale Error

03437-0-008

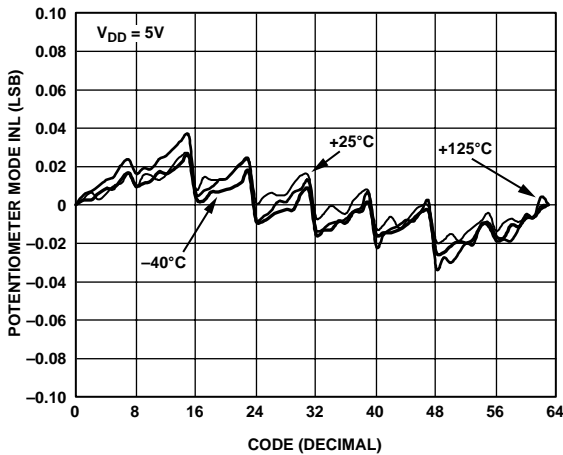

Figure 7. INL vs. Code vs. Temperature

03437-0-006

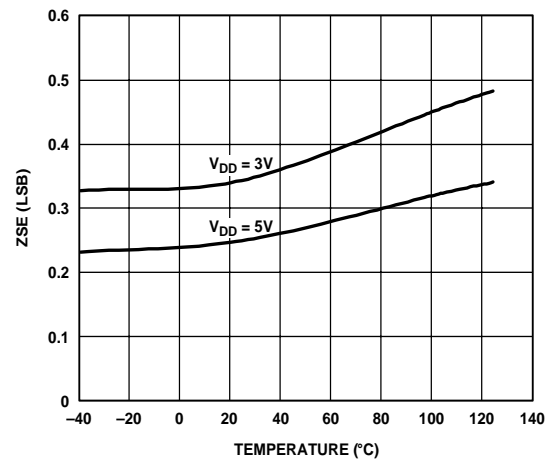

Figure 10. Zero-Scale Error

03437-0-009

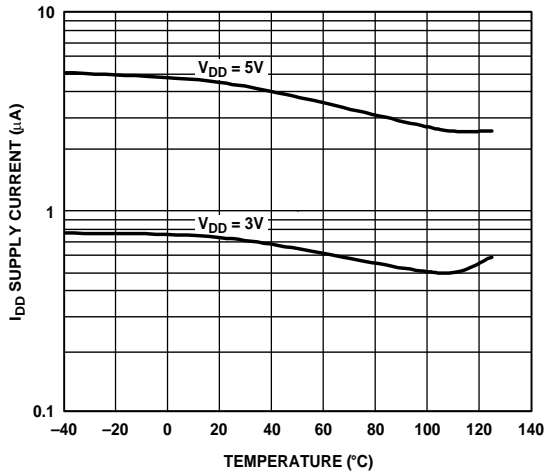

Figure 11. Supply Current vs. Temperature

03437-0-010

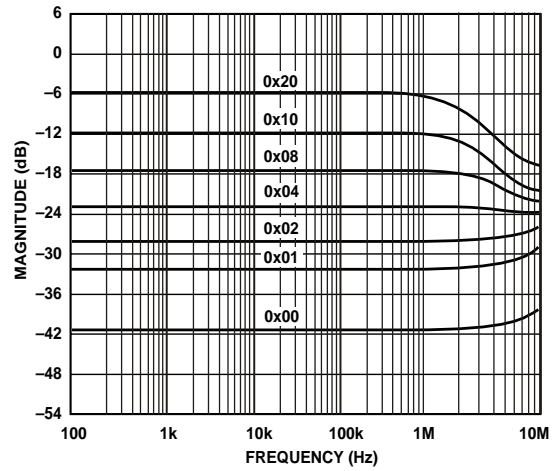

Figure 14. Gain vs. Frequency vs. Code, $R_{AB} = 5\text{ k}\Omega$

03437-0-013

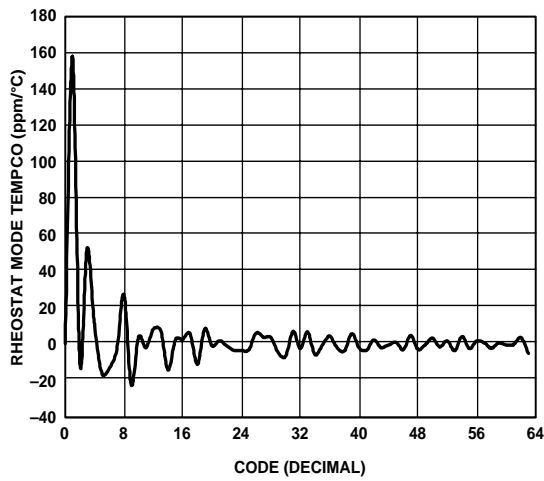

Figure 12. Rheostat Mode Tempco ($\Delta R_{AB}/R_{AB}$)/ ΔT vs. Code

03437-0-011

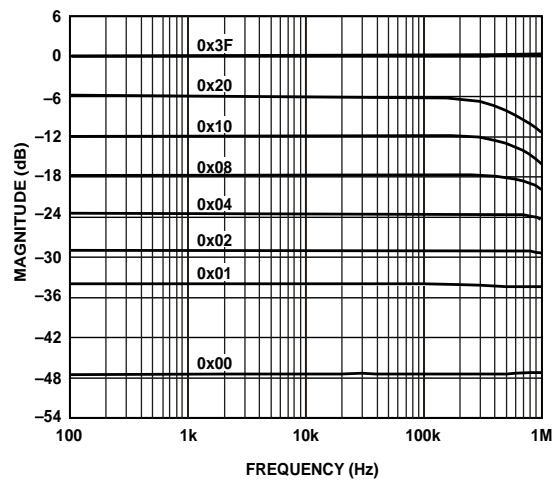

Figure 15. Gain vs. Frequency vs. Code, $R_{AB} = 10\text{ k}\Omega$

03437-0-001

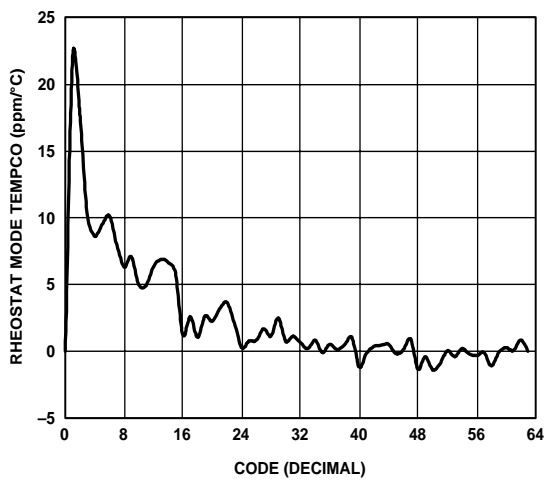

Figure 13. Potentiometer Mode Tempco ($\Delta V_W/V_W$)/ ΔT vs. Code

03437-0-012

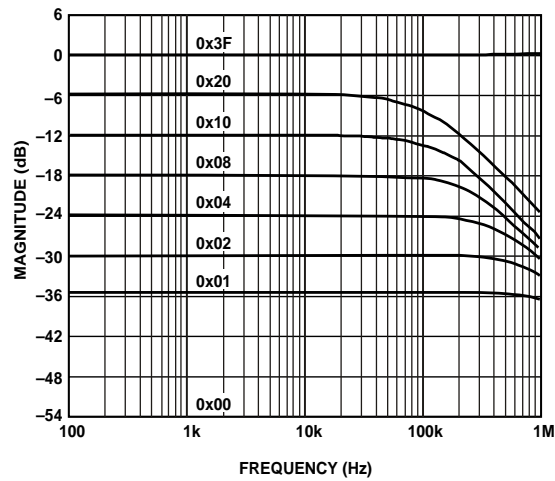

Figure 16. Gain vs. Frequency vs. Code, $R_{AB} = 50\ \Omega$

03437-0-015

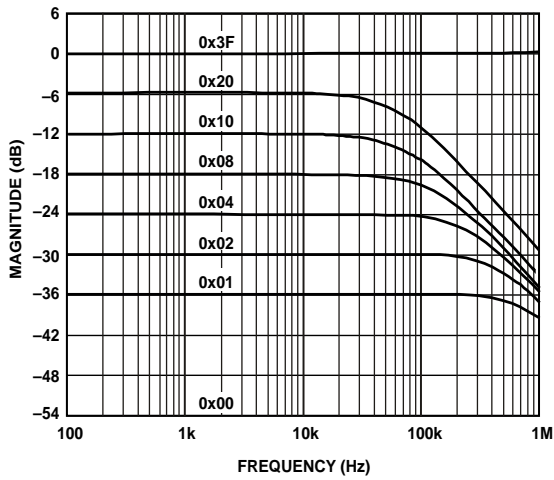

Figure 17. Gain vs. Frequency vs. Code, $R_{AB} = 100\text{ k}\Omega$

03437-0-016

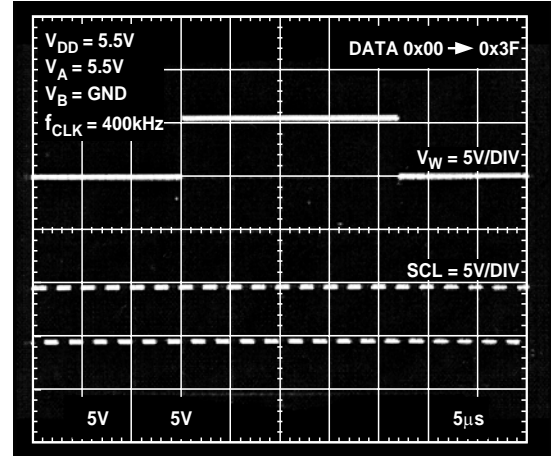

Figure 20. Settling Time

03437-0-019

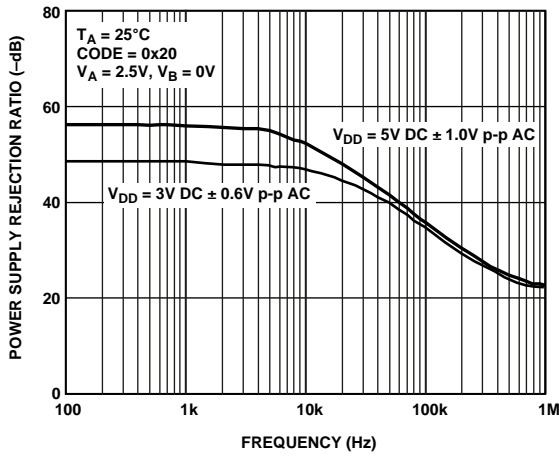

Figure 18. PSRR vs. Frequency

03437-0-017

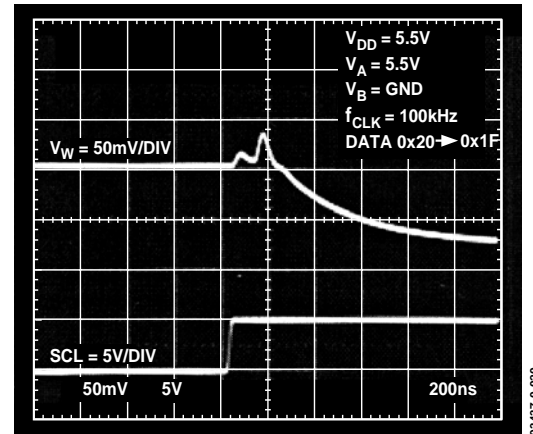

Figure 21. Midscale Glitch Energy

03437-0-020

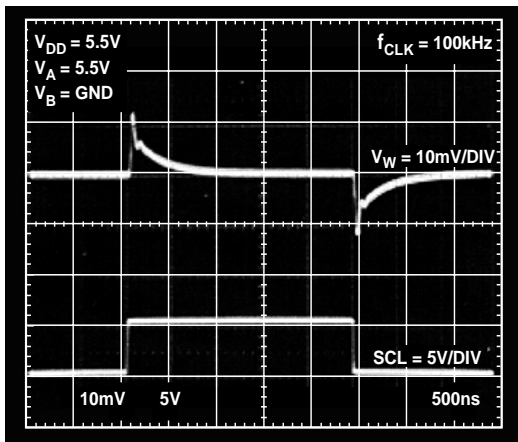

Figure 19. Digital Feedthrough vs. Time

03437-0-018

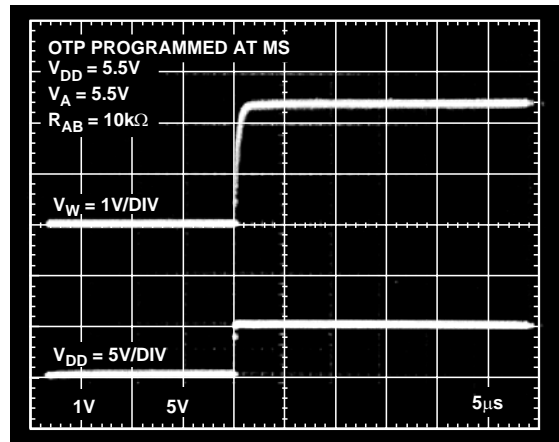
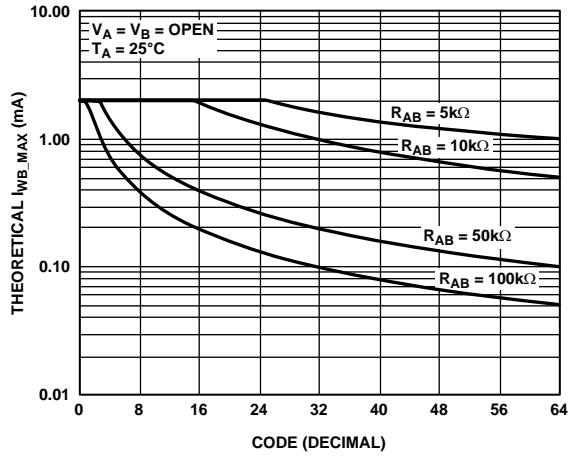

Figure 22. Power-Up Settling Time, after Fuses Blown

03437-0-021



03437-0-022

Figure 23. I_{WB_MAX} vs. Code

THEORY OF OPERATION

The AD5171 allows unlimited 6-bit adjustments, except for the one-time programmable, set-and-forget resistance setting. OTP technology is a proven, cost-effective alternative over EEMEM in one-time memory programming applications. AD5171 employs fuse link technology to achieve the memory retention of the resistance setting function. It comprises six data fuses that control the address decoder for programming the RDAC, one user mode test fuse for checking setup error, and one programming lock fuse for disabling any further programming once the data fuses are blown.

ONE-TIME PROGRAMMING (OTP)

Prior to OTP activation, the AD5171 presets to mid-scale during initial power-on. After the wiper is set at the desired position, the resistance can be permanently set by programming the T bit high along with the proper coding (see Table 7 and Table 8) and one time V_{DD_OTP} . Note that fuse link technology of the AD517x family of digital pots requires V_{DD_OTP} between 5.25 V and 5.5 V to blow the fuses to achieve a given nonvolatile setting. On the other hand, V_{DD} can be 2.7 V to 5.5 V during operation. As a result, system supply that is lower than 5.25 V requires external supply for one-time programming. Note also that the user is allowed only one attempt in blowing the fuses. If the user fails to blow the fuses at the first attempt, the fuse structures may change so that they may never be blown regardless of the energy applied at subsequent events. For details, see Power Supply Considerations section.

The device control circuit has two validation bits, E1 and E0, that can be read back to check the programming status (see Table 4). Users should always read back the validation bits to ensure that the fuses are properly blown. After the fuses have been blown, all fuse latches are enabled upon subsequent power-on; therefore, the output corresponds to the stored setting.

Table 4. Validation Status

E1	E0	Status
0	0	Ready for Programming.
0	1	Test Fuse Not Blown Successfully. For factory setup checking purpose only. Users should not see these combinations.
1	0	Fatal Error. Some fuses are not blown. Do not retry. Discard the unit.
1	1	Successful. No further programming is possible.

This section discusses the fuse operation in detail. When the OTP T bit is set, the internal clock is enabled. The program then attempts to blow a test fuse. The operation stops if the test fuse is not properly blown. The validation bits, Bit E1 and Bit E0, show 01. This status is intended for factory setup checking purposes only; users should not see this status. If the test fuse is properly blown, then the data fuses can be programmed. The six data fuses are programmed in six clock cycles. The output of

the fuses is compared with the code stored in the RDAC register. If they do not match, E1 and E0 of 10 are issued as fatal errors and the operation stops. Users should never try blowing the fuses more than once because the fuse structure may have changed prohibiting further programming. As a result, the unit must be discarded. This error status can also occur if the OTP supply voltage goes above or drops below V_{DD_OTP} requirement, the OTP supply current is limited, or both the voltage and current ramp times are slow. If the output and stored code match, the programming lock fuse is blown so that no further programming is possible. In the meantime, E1 and E0 issue 11, indicating the lock fuse is properly blown. All the fuse latches are enabled at power-on, therefore, from this point on, the output corresponds to the stored setting. Figure 24 shows a detailed functional block diagram.

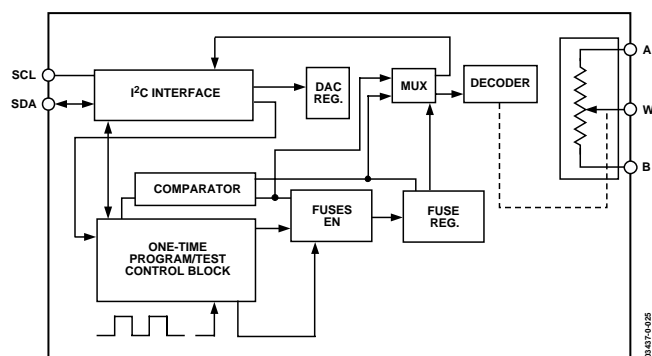

Figure 24. Detailed Functional Block Diagram

POWER SUPPLY CONSIDERATIONS

To minimize the package pin count, both the one-time programming and normal operating voltage supplies share the same V_{DD} terminal of the AD5171. The AD5171 employs fuse link technology that requires 5.25 V to 5.5 V for blowing the internal fuses to achieve a given setting, but normal V_{DD} can be anywhere between 2.7 V and 5.5 V after the fuse programming process. As a result, dual voltage supplies and isolation are needed if system V_{DD} is lower than the required V_{DD_OTP} . The fuse programming supply (either an on-board regulator or rack-mount power supply) must be rated at 5.25 V to 5.5 V and able to provide a 100 mA current for 400 ms for successful one-time programming. Once fuse programming has been completed, the V_{DD_OTP} supply must be removed to allow normal operation at 2.7 V to 5.5 V and the device will consume current in μA range. Figure 25 shows the simplest implementation to meet the dual voltage requirement with a jumper. This approach saves one voltage supply, but draws additional current and requires manual configuration.

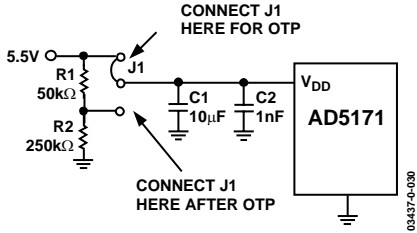

Figure 25. Power Supply Requirement

An alternate approach in 3.5 V to 5.25 V systems adds a signal diode between the system supply and the OTP supply for isolation, as shown in Figure 26.

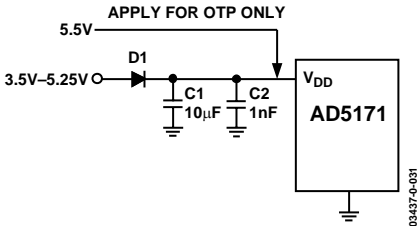

Figure 26. Isolating the 5.5 V OTP Supply from the 3.5 V to 5.25 V Normal Operating Supply. The V_{DD_OTP} supply must be removed once OTP is complete.

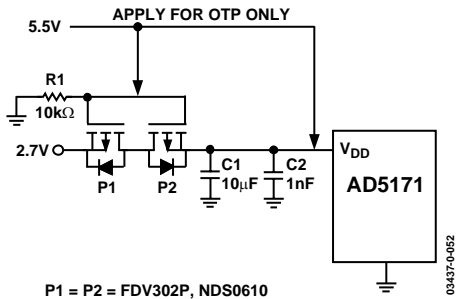

Figure 27. Isolating the 5.5 V OTP Supply from the 2.7 V Normal Operating Supply. The V_{DD_OTP} supply must be removed once OTP is complete.

For users who operate their systems at 2.7 V, use of the bidirectional low threshold P-Ch MOSFETs is recommended for the supply's isolation. As shown in Figure 27, this assumes that the 2.7 V system voltage is applied first, and the P1 and P2 gates are pulled to ground, thus turning on P1 and, subsequently, P2. As a result, V_{DD} of the AD5171 approaches 2.7 V. When the AD5171 setting has been found, the factory tester applies the V_{DD_OTP} to both the V_{DD} and the MOSFETs gates thus turning off P1 and P2. The OTP command should be executed at this time to program the AD5171 while the 2.7 V source is protected. Once the fuse programming is completed, the tester withdraws the V_{DD_OTP} and the AD5171's setting is permanently fixed.

AD5171 achieves the OTP function through blowing internal fuses. Users should always apply the 5.25 V to 5.5 V one-time program voltage requirement at the first fuse programming attempt. Failure to comply with this requirement may lead to a

change in the fuse structures, rendering programming inoperable.

Poor PCB layout introduces parasitics that may affect the fuse programming. Therefore, it is recommended that a 10 μ F tantalum capacitor be added in parallel with a 1 nF ceramic capacitor as close as possible to the V_{DD} pin. The type and value chosen for both capacitors are important. This combination of capacitor values provides both a fast response and larger supply current handling with minimum supply droop during transients. As a result, these capacitors increase the OTP programming success by not inhibiting the proper energy needed to blow the internal fuses. Additionally, C1 minimizes transient disturbance and low frequency ripple while C2 reduces high frequency noise during normal operation.

ESD PROTECTION

Digital inputs SDA and SCL are protected with a series input resistor and parallel Zener ESD structures (Figure 28).

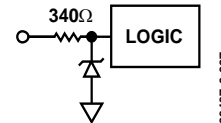

Figure 28. ESD Protection of Digital Pins

TERMINAL VOLTAGE OPERATING RANGE

There are also ESD protection diodes between V_{DD} and the RDAC terminals; therefore, the V_{DD} of the AD5171 defines their voltage boundary conditions (see Figure 29). Supply signals present on Terminal A, Terminal B, and Terminal W that exceed V_{DD} are clamped by the internal forward-biased diodes and should be avoided.

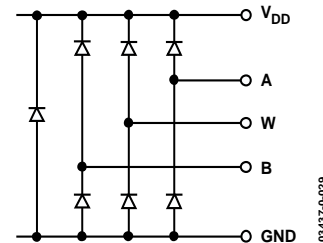

Figure 29. Maximum Terminal Voltages Set by V_{DD}

POWER-UP/POWER-DOWN SEQUENCES

Similarly, because of the ESD protection diodes, it is important to power V_{DD} first before applying any voltages to Terminal A, Terminal B, and Terminal W. Otherwise, the diode is forward-biased such that V_{DD} is powered unintentionally and may affect the remainder of the users' circuits. The ideal power-up sequence is in the following order: GND, V_{DD} , digital inputs, and $V_A/V_B/V_W$. The order of powering V_A , V_B , V_W , and the digital inputs is not important as long as they are powered after V_{DD} . Similarly, V_{DD} should be powered down last.

DETERMINING THE VARIABLE RESISTANCE AND VOLTAGE

Rheostat Mode Operation

If only the W-to-B or W-to-A terminals are used as variable resistors, the unused terminal can be opened or shorted to Terminal W. This operation is called rheostat mode (Figure 30).

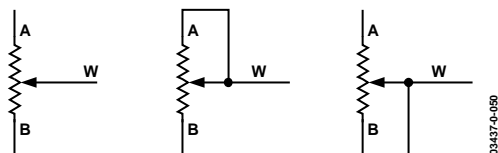

Figure 30. Rheostat Mode Configuration

The nominal resistance (R_{AB}) of the RDAC has 64 contact points accessed by the wiper terminal, plus the B terminal contact if R_{WB} is considered. The 6-bit data in the RDAC latch is decoded to select one of the 64 settings. Assuming that a 10 k Ω part is used, the wiper's first connection starts at the B terminal for data 0x00. Such a connection yields a minimum of 60 Ω resistance between Terminal W and Terminal B due to the 60 Ω wiper contact resistance. The second connection is the first tap point, which corresponds to 219 Ω ($R_{WB} = 1 \times R_{AB}/63 + R_W$) for data 0x01, and so on. Each LSB data value increase moves the wiper up the resistor ladder until the last tap point is reached at 10060 Ω ($(63) \times R_{AB}/63 + R_W$). Figure 31 shows a simplified diagram of the equivalent RDAC circuit. The general equation determining R_{WB} is

$$R_{WB}(D) = \frac{D}{63} \times R_{AB} + R_W \tag{1}$$

where:

D is the decimal equivalent of the 6-bit binary code.

R_{AB} is the end-to-end resistance.

R_W is the wiper resistance contributed by the on-resistance of the internal switch.

Table 5. R_{WB} vs. Codes

$R_{AB} = 10 \text{ k}\Omega$ and Terminal A Is Opened

D (Dec)	R_{WB} (Ω)	Output State
63	10060	Full-Scale ($R_{AB} + R_W$)
32	5139	Midscale
1	219	1 LSB
0	60	Zero-Scale (Wiper Contact Resistance)

Since a finite wiper resistance of 60 Ω is present in the zero-scale condition, care should be taken to limit the current flow between Terminal W and Terminal B in this state to a maximum pulse current of no more than 20 mA. Otherwise, degradation or possible destruction of the internal switch contact can occur.

Similar to the mechanical potentiometer, the resistance of the RDAC between the wiper (Terminal W) and Terminal A also

produces a complementary resistance R_{WA} . When these terminals are used, the B terminal can be opened or shorted to Terminal W. Setting the resistance value for R_{WA} starts at a maximum value of resistance and decreases as the data loaded in the latch increases in value. The general equation for this operation is

$$R_{WA}(D) = \frac{63 - D}{63} \times R_{AB} + R_W \tag{2}$$

Table 6. R_{WA} vs. Codes; $R_{AB} = 10 \text{ k}\Omega$ and Terminal B Is Opened

D (Dec)	R_{WA} (Ω)	Output State
63	60	Full-Scale
32	4980	Midscale
1	9901	1 LSB
0	10060	Zero-Scale

The typical distribution of the resistance tolerance from device to device is process lot dependent; it is possible to have $\pm 30\%$ tolerance.

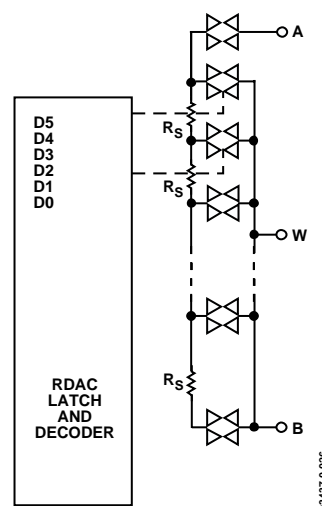

Figure 31. AD5171 Equivalent RDAC Circuit

Potentiometer Mode Operation

If all three terminals are used, the operation is called the potentiometer mode. The most common configuration is the voltage divider operation (Figure 32).

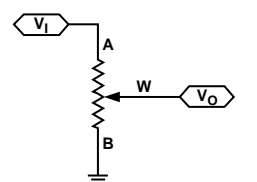

Figure 32. Potentiometer Mode Configuration

AD5171

Ignoring the effect of the wiper resistance, the transfer function is simply

$$V_W(D) = \frac{D}{63} V_A \quad (3)$$

A more accurate calculation, which includes the wiper resistance effect, yields

$$V_W(D) = \frac{D}{63} \frac{R_{AB} + R_W}{R_{AB} + 2R_W} V_A \quad (4)$$

Unlike in rheostat mode operation where the absolute tolerance is high, potentiometer mode operation yields an almost ratio-metric function of $D/63$ with a relatively small error contributed by the R_W terms; thus, the tolerance effect is almost cancelled. Although the thin film step resistor (R_S) and CMOS switches resistance (R_W) have very different temperature coefficients, the ratiometric adjustment also reduces the overall temperature coefficient effect to 5 ppm/°C, except at low value codes where R_W dominates.

Potentiometer mode operations include others such as op amp input, feedback resistor networks, and other voltage scaling applications. Terminal A, Terminal W, and Terminal B can, in fact, be input or output terminals provided that $|V_{AB}|$, $|V_{WA}|$, and $|V_{WB}|$ do not exceed V_{DD} to GND.

CONTROLLING THE AD5171

There are two ways of controlling the AD5171. Users can either program the devices with computer software or employ external I²C controllers.

Software Programming

Due to the advantage of the one-time programmable feature, users may consider programming the device in the factory before shipping to end users. ADI offers device programming software that can be implemented in the factory on PCs running Windows 95 to Windows XP platforms. As a result, external controllers are not required, which significantly reduces development time. The program is an executable file that does not require the user to know any programming languages or programming skills. It is easy to set up and use. Figure 33 shows the software interface. The software can be downloaded from www.analog.com.

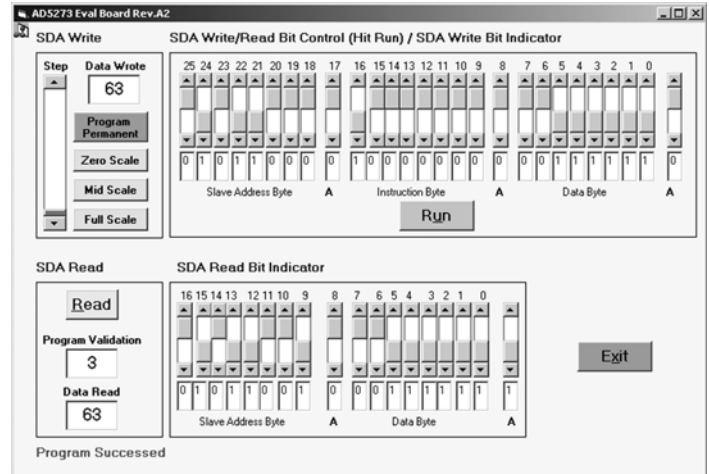

Figure 33. AD5171 Computer Software Interface

Write

The AD5171 starts at midscale after power-up prior to the OTP programming. To increment or decrement the resistance, the user may simply move the scrollbar on the left. To write any specific values, the user should use the bit pattern control in the upper screen and press the Run button. The format of writing data to the device is shown in Table 7. Once the desired setting is found, the user may press the Program Permanent button to blow the internal fuse links for permanent setting. The user may also set the programming bit pattern in the upper screen and press the Run button to achieve the same result.

Read

To read the validation bits and data from the device, the user may simply press the Read button. The user may also set the bit pattern in the upper screen and press the Run button. The format of reading data out from the device is shown in Table 8.

To apply the device programming software in the factory, users need to modify a parallel port cable and configure Pin 2, Pin 3, Pin 15, and Pin 25 for SDA_write, SCL, SDA_read, and DGND, respectively, for the control signals (Figure 34). Users should also lay out the PCB of the AD5171 with SCL and SDA pads, as shown in Figure 35, such that pogo pins can be inserted for the factory programming.

AD5171

Table 7. SDA Write Mode Bit Format

S	0	1	0	1	1	0	AD0	0	A	T	X	X	X	X	X	X	X	A	X	X	D5	D4	D3	D2	D1	D0	A	P
Slave Address Byte									Instruction Byte									Data Byte										

Table 8. SDA Read Mode Bit Format

S	0	1	0	1	1	0	AD0	1	A	E1	E0	D5	D4	D3	D2	D1	D0	A	P
Slave Address Byte									Data Byte										

Table 9. SDA Bits Definitions and Descriptions

Bit	Description
S	Start Condition.
P	Stop Condition.
A	Acknowledge.
AD0	I ² C Device Address Bit. Allows maximum of two AD5171s to be addressed.
X	Don't Care.
T	OTP Programming Bit. Logic 1 programs wiper position permanently.
D5, D4, D3, D2, D1, D0	Data Bits.
E1, E0	OTP Validation Bits.
0, 0	Ready to Program.
0, 1	Test Fuse Not Blown Successfully. For factory setup checking purpose only. Users should not see these combinations.
1, 0	Fatal Error. Do not retry. Discard the unit.
1, 1	Programmed Successfully. No further adjustments possible.

I²C Controller Programming

Write Bit Pattern Illustrations

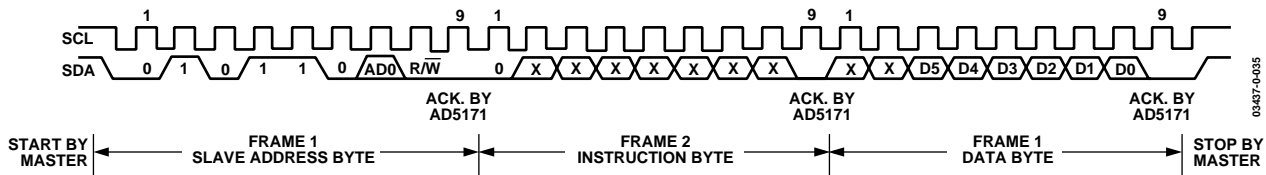

Figure 36. Writing to the RDAC Register

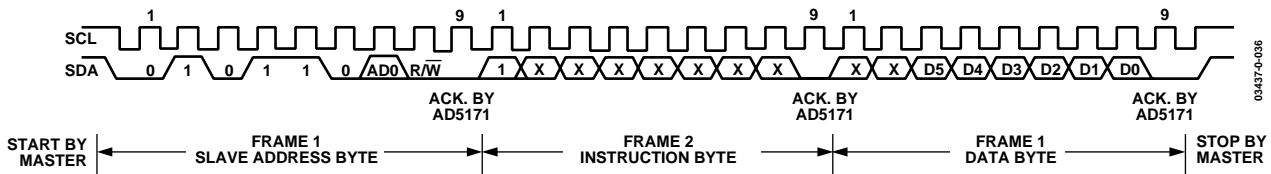

Figure 37. Activating One-Time Programming

Read Bit Pattern Illustration

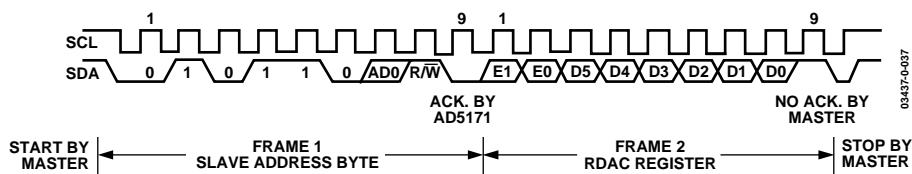

Figure 38. Reading Data from RDAC Register

I²C COMPATIBLE 2-WIRE SERIAL BUS

For users who prefer to use external controllers, the AD5171 can be controlled via an I²C compatible serial bus; the part is connected to this bus as a slave device. Referring to Figure 36, Figure 37, and Figure 38, the 2-wire I²C serial bus protocol operates as follows:

1. The master initiates data transfer by establishing a START condition, which is when SDA goes from high to low while SCL is high (Figure 36 and Figure 37). The following byte is the slave address byte, which consists of the 6 MSBs as a slave address defined as 010110. The next bit is AD0, which is an I²C device address bit. Depending on the states of their AD0 bits, two AD5171s can be addressed on the same bus (Figure 39). The last LSB is the R/W bit, which determines whether data is read from, or written to, the slave device.

The slave address corresponding to the transmitted address bit responds by pulling the SDA line low during the 9th clock pulse (this is termed the Acknowledge bit). At this stage, all other devices on the bus remain idle while the selected device waits for data to be written to, or read from, its serial register.

2. The write operation contains one instruction byte more than the read operation. The instruction byte in the write mode follows the slave address byte. The MSB of the instruction byte labeled T is the one-time programming bit. After acknowledging the instruction byte, the last byte in the write mode is the data byte. Data is transmitted over the serial bus in sequences of nine clock pulses (eight data bits followed by an Acknowledge bit). The transitions on the SDA line must occur during the low period of SCL and remain stable during the high period of SCL (Figure 36).
3. In the read mode, the data byte follows immediately after the acknowledgment of the slave address byte. Data is transmitted over the serial bus in sequences of nine clock pulses (note the slight difference from the write mode; there are eight data bits followed by a No Acknowledge bit). Similarly, the transitions on the SDA line must occur during the low period of SCL and remain stable during the high period of SCL (Figure 38).

4. When all data bits have been read or written, a stop condition is established by the master. A stop condition is defined as a low-to-high transition on the SDA line while SCL is high. In the write mode, the master pulls the SDA line high during the 10th clock pulse to establish a stop condition (Figure 36 and Figure 37). In the read mode, the master issues a No Acknowledge for the 9th clock pulse, i.e., the SDA line remains high. The master then brings the SDA line low before the 10th clock pulse, which goes high to establish a STOP condition (Figure 38).

A repeated write function gives the user flexibility to update the RDAC output a number of times, except after permanent programming, addressing, and instructing the part only once. During the write cycle, each data byte updates the RDAC output. For example, after the RDAC has acknowledged its slave address and instruction bytes, the RDAC output updates after these two bytes. If another byte is written to the RDAC while it is still addressed to a specific slave device with the same instruction, this byte updates the output of the selected slave device. If different instructions are needed, the write mode has to be started with a new slave address, instruction, and data bytes. Similarly, a repeated read function of the RDAC is also allowed.

CONTROLLING TWO DEVICES ON ONE BUS

Figure 39 shows two AD5171 devices on the same serial bus. Each has a different slave address since the state of each AD0 pin is different. This allows each device to be independently operated. The master device output bus line drivers are open-drain pull-downs in a fully I²C compatible interface.

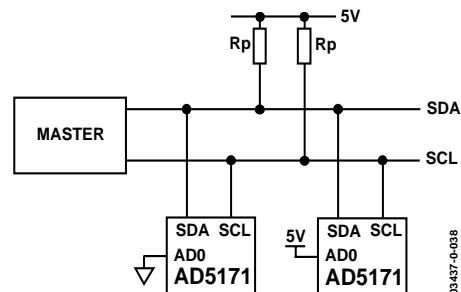

Figure 39. Two AD5171 Devices on One Bus

APPLICATIONS

DAC

It is common to buffer the output of the digital potentiometer as a DAC unless the load is much larger than R_{WB} . The buffer serves the purpose of impedance conversion as well as delivering higher current, which may be needed.

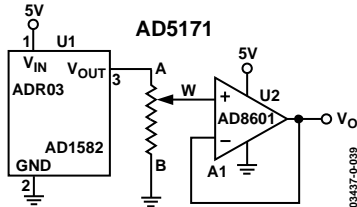

Figure 40. Programmable Voltage Reference (DAC)

GAIN CONTROL COMPENSATION

The digital potentiometers are commonly used in gain controls (Figure 41) or sensor transimpedance amplifier signal conditioning applications. To avoid gain peaking or in worst-case oscillation due to step response, a compensation capacitor is needed. In general, C_2 in the range of a few picofarads to no more than a few tenths of a picofarad is adequate for the compensation.

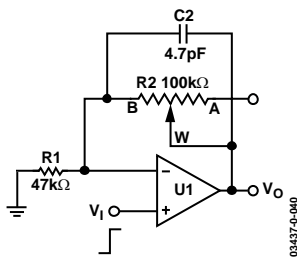

Figure 41. Typical Noninverting Gain Amplifier

PROGRAMMABLE VOLTAGE SOURCE WITH BOOSTED OUTPUT

For applications that require high current adjustment, such as a laser diode driver or tunable laser, a boosted voltage source can be considered (Figure 42).

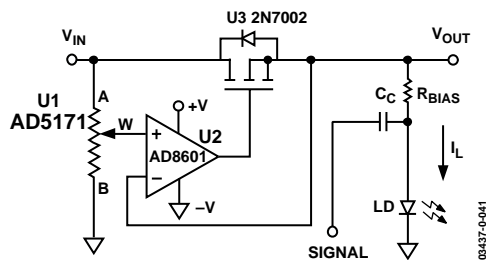

Figure 42. Programmable Booster Voltage Source

In this circuit, the inverting input of the op amp forces the V_{OUT} to be equal to the wiper voltage set by the digital potentiometer.

The load current is then delivered by the supply via the N-Ch FET N_1 . N_1 power handling must be adequate to dissipate $(V_1 - V_O) \times I_L$ power. This circuit can source a maximum of 100 mA with a 5 V supply. For precision applications, a voltage reference such as ADR421, ADR03, or ADR370 can be applied at Terminal A of the digital potentiometer.

LEVEL SHIFTING FOR DIFFERENT VOLTAGE OPERATION

When users need to interface a 2.5 V controller with the AD5171, a proper voltage level shift must be used so that the digital potentiometer can be read from, or written to, the controller; Figure 43 shows one of the implementations. M_1 and M_2 should be low threshold N-Ch power MOSFETs, such as FDV301N.

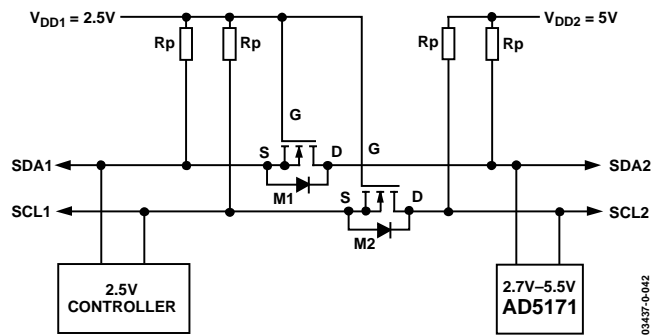

Figure 43. Level Shifting for Different Voltage Operation

RESISTANCE SCALING

The AD5171 offers 5 k Ω , 10 k Ω , 50 k Ω , and 100 k Ω nominal resistances. For users who need to optimize the resolution with an arbitrary full range resistance, the following techniques can be used. By paralleling a discrete resistor (Figure 44), a proportionately lower voltage appears at Terminal A to Terminal B, which is applicable only to the voltage divider mode.

This translates into a finer degree of precision because the step size at Terminal W is smaller. The voltage can be found as

$$V_W(D) = \frac{(R_{AB} \parallel R_2)}{R_3 + R_{AB} \parallel R_2} \times \frac{D}{64} \times V_{DD} \quad (5)$$

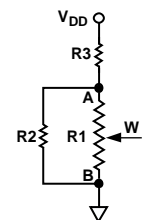

Figure 44. Lowering the Nominal Resistance

For log taper adjustment, such as volume control, Figure 45 shows another way of resistance scaling to achieve the log taper function. In this circuit, the smaller the R2 with respect to RAB, the more it behaves like the pseudo log taper characteristic. The wiper voltage is simply

$$V_W(D) = \frac{(R_{WB} \parallel R2)}{R_{WA} + R_{WB} \parallel R2} \times V_I \quad (6)$$

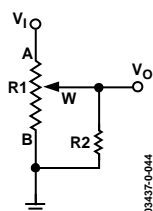

Figure 45. Resistor Scaling with Log Adjustment Characteristics

RESOLUTION ENHANCEMENT

The resolution can be doubled in the potentiometer mode of operation by using three digital potentiometers. Borrowed from ADI's patented RDAC segmentation technique, users can configure three AD5171s (Figure 46) to double the resolution. First, U3 must be parallel with a discrete resistor, RP, which is chosen to be equal to a step resistance (RP = RAB/64). Adjusting U1 and U2 together forms the coarse 6-bit adjustment, and adjusting U3 alone forms the finer 6-bit adjustment. As a result, the effective resolution becomes 12-bit.

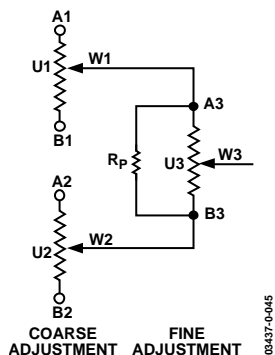

Figure 46. Doubling the Resolution

RDAC CIRCUIT SIMULATION MODEL

The internal parasitic capacitances and the external capacitive loads dominate the ac characteristics of the digital potentiometers. Configured as a potentiometer divider, the -3 dB bandwidth of the AD5171 (5 kΩ resistor) measures 1.5 MHz at half scale. Figure 14 to Figure 17 provide the large signal BODE plot characteristics of the four available resistor versions: 5 kΩ, 10 kΩ, 50 kΩ, and 100 kΩ. A parasitic simulation model is shown in Figure 47. Listing 1 provides a macro model net list for the 10 kΩ device.

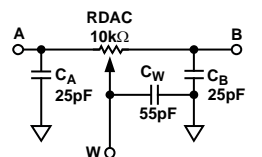

Figure 47. Circuit Simulation Model for RDAC = 10 kΩ

Listing 1. Macro Model Net List for RDAC

```
.PARAM D=64 , RDAC=10E3
*
.SUBCKT DPOT (A, W, B)
*
CA A 0 25E-12
RWA A W { (1-D/64) *RDAC+60 }
CW W 0 55E-12
RWB W B { D/64 *RDAC+60 }
CB B 0 25E-12
*
.ENDS DPOT
```

AD5171

AD5171 EVALUATION BOARD

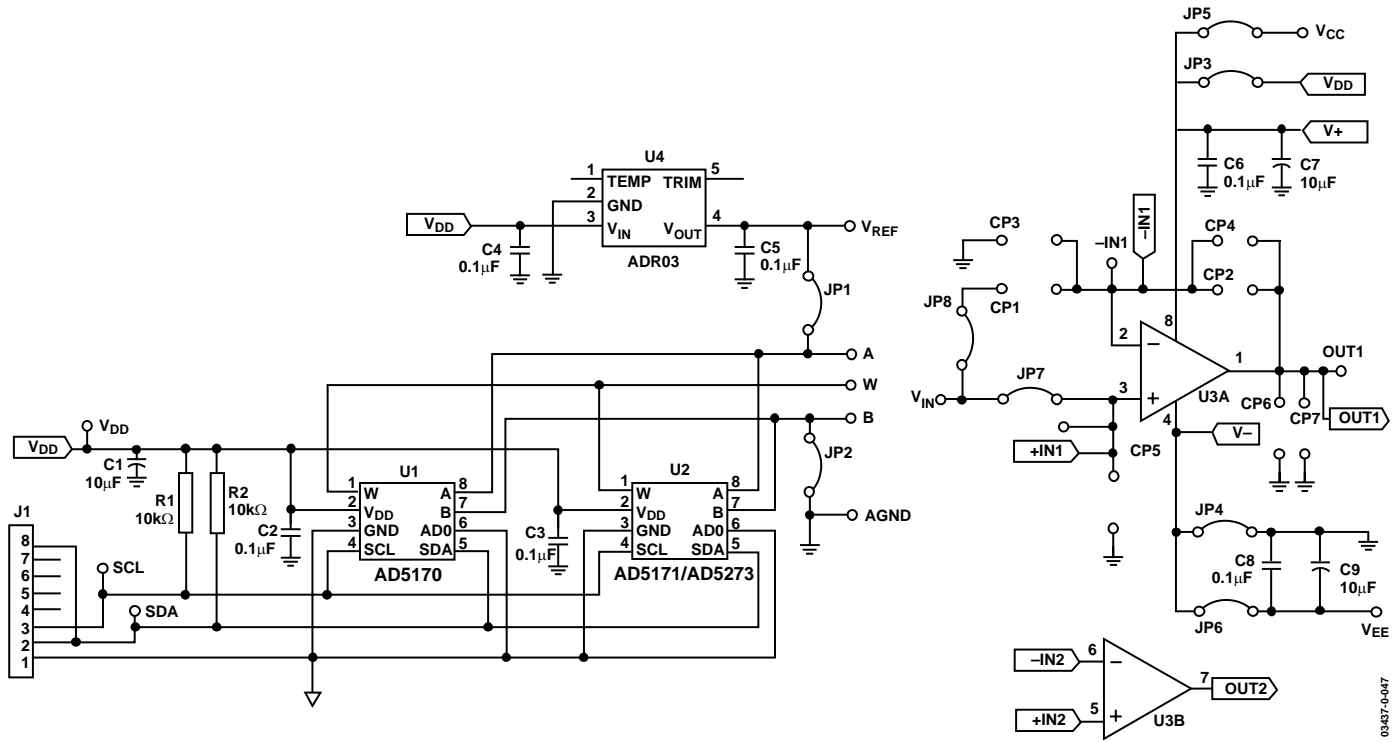

Figure 48. AD5171 Evaluation Board Schematic

The AD5171 evaluation board comes with a dual op amp AD822 and a 2.5 V reference ADR03. Users can configure many building block circuits with minimum components needed. Figure 49 shows one of the examples. There is space available on the board where users can build additional circuits for further evaluations, see Figure 50.

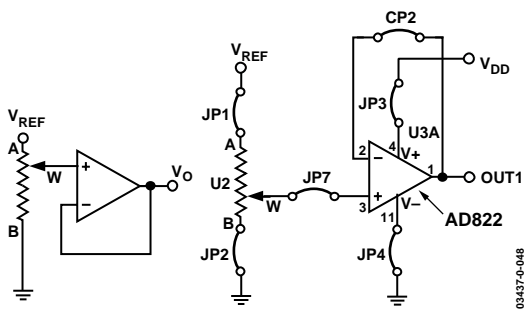

Figure 49. Programmable Voltage Reference

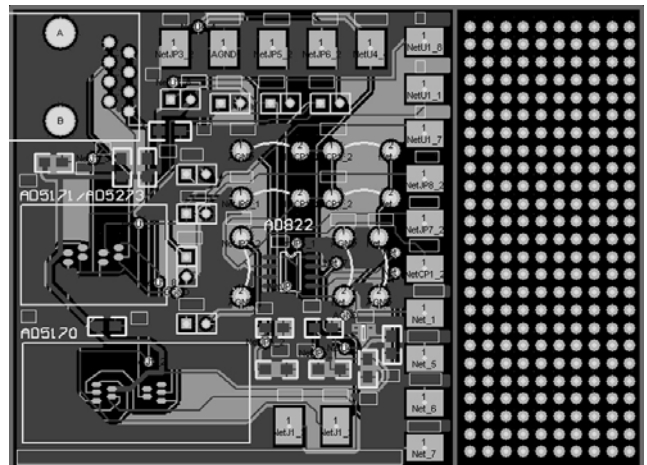

Figure 50. AD5171 Evaluation Board

OUTLINE DIMENSIONS

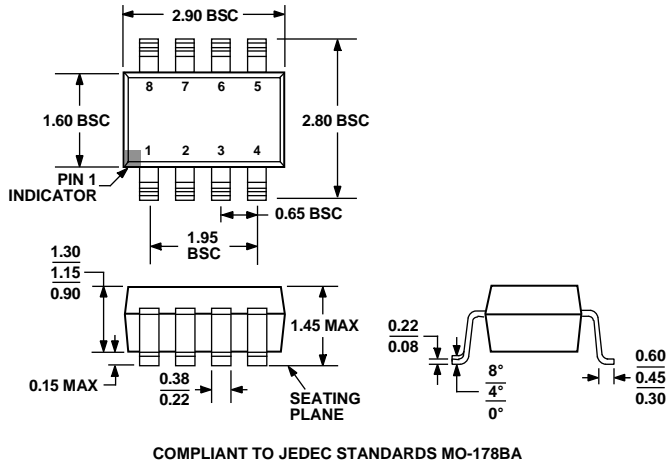

Figure 51. 8-Lead Small Outline Transistor Package [SOT-23] (RJ-8)
Dimensions shown in millimeters

ORDERING GUIDE

Model	R _{AB} (kΩ)	Package Code	Package Description	Full Container Quantity	Branding
AD5171BRJ5-R2	5	RJ-8	SOT-23-8	250	D12
AD5171BRJ5-RL7	5	RJ-8	SOT-23-8	3000	D12
AD5171BRJZ5-R2 ¹	5	RJ-8	SOT-23-8	250	D12
AD5171BRJZ5-R7 ¹	5	RJ-8	SOT-23-8	3000	D12
AD5171BRJ10-R2	10	RJ-8	SOT-23-8	250	D13
AD5171BRJ10-RL7	10	RJ-8	SOT-23-8	3000	D13
AD5171BRJZ10-R2 ¹	10	RJ-8	SOT-23-8	250	D13
AD5171BRJZ10-R7 ¹	10	RJ-8	SOT-23-8	3000	D13
AD5171BRJ50-R2	50	RJ-8	SOT-23-8	250	D14
AD5171BRJ50-RL7	50	RJ-8	SOT-23-8	3000	D14
AD5171BRJZ50-R2 ¹	50	RJ-8	SOT-23-8	250	D14
AD5171BRJZ50-R7 ¹	50	RJ-8	SOT-23-8	3000	D14
AD5171BRJ100-R2	100	RJ-8	SOT-23-8	250	D15
AD5171BRJ100-RL7	100	RJ-8	SOT-23-8	3000	D15
AD5171BRJZ100-R2 ¹	100	RJ-8	SOT-23-8	250	D15
AD5171BRJZ100-R7 ¹	100	RJ-8	SOT-23-8	3000	D15
AD5171EVAL ²	10		Evaluation Board	1	

¹ Z = Pb-free part.

² The evaluation board is shipped with three pieces of 10 kΩ parts. Users should order extra samples or different resistance options if needed.

AD5171

NOTES

NOTES

AD5171

NOTES

Purchase of licensed I²C components of Analog Devices or one of its sublicensed Associated Companies conveys a license for the purchaser under the Philips I²C Patent Rights to use these components in an I²C system, provided that the system conforms to the I²C Standard Specification as defined by Philips.



LittleDiode supplies new, hard to find or obsolete electronic components and semiconductors all over the world.

With over two million different components listed you are sure to find the part you need.

Feel free to visit us today at our online store:

LittleDiode.com

Looking forward to providing you with the best possible service.