

Features

- Epitaxial Planar Die Construction
- Complementary PNP Type Available (DCP69)
- Ideally Suited for Automated Assembly Processes
- Ideal for Medium Power Switching or Amplification Applications
- **Lead Free By Design/RoHS Compliant (Note 1)**
- **"Green" Device (Note 2)**

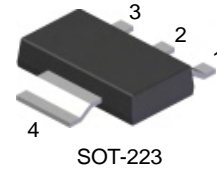

Mechanical Data

- Case: SOT-223
- Case Material: Molded Plastic, "Green" Molding Compound. UL Flammability Classification Rating 94V-0
- Moisture Sensitivity: Level 1 per J-STD-020D
- Terminals: Finish - Matte Tin annealed over Copper leadframe (Lead Free Plating). Solderable per MIL-STD-202, Method 208
- Marking Information: See Page 3
- Ordering Information: See Page 3
- Weight: 0.115 grams

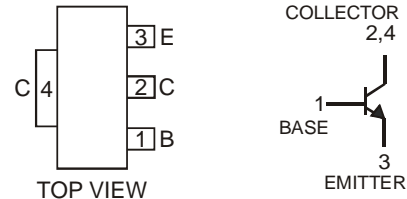

Maximum Ratings @ $T_A = 25^\circ\text{C}$ unless otherwise specified

Characteristic	Symbol	Value	Units
Collector-Base Voltage	V_{CBO}	25	V
Collector-Emitter Voltage	V_{CEO}	20	V
Emitter-Base Voltage	V_{EBO}	5.0	V
Collector Current	I_C	1.0	A

Thermal Characteristics

Characteristic	Symbol	Value	Unit
Power Dissipation @ $T_A = 25^\circ\text{C}$ (Note 3)	P_D	1	W
Thermal Resistance, Junction to Ambient Air @ $T_A = 25^\circ\text{C}$ (Note 3)	$R_{\theta JA}$	125	$^\circ\text{C}/\text{W}$
Operating and Storage Temperature Range	T_J, T_{STG}	-55 to 150	$^\circ\text{C}$

Electrical Characteristics @ $T_A = 25^\circ\text{C}$ unless otherwise specified

Characteristic	Symbol	Min	Typ	Max	Unit	Test Condition	
OFF CHARACTERISTICS (Note 4)							
Collector-Emitter Breakdown Voltage	$V_{(BR)CES}$	25	—	—	V	$I_C = 100\mu\text{A}, I_E = 0$	
Collector-Emitter Breakdown Voltage	$V_{(BR)CEO}$	20	—	—	V	$I_C = 1.0\text{mA}, I_B = 0$	
Collector-Base Breakdown Voltage	$V_{(BR)CBO}$	25	—	—	V	$I_C = 10\mu\text{A}, I_E = 0$	
Emitter-Base Breakdown Voltage	$V_{(BR)EBO}$	5.0	—	—	V	$I_E = 10\mu\text{A}, I_C = 0$	
Collector-Base Cutoff Current	I_{CBO}	—	—	100	nA	$V_{CB} = 25\text{V}, I_E = 0$	
Emitter-Base Cutoff Current	I_{EBO}	—	—	10	μA	$V_{EB} = 5.0\text{V}, I_C = 0$	
ON CHARACTERISTICS (Note 4)							
DC Current Gain	h_{FE}	DCP68, DCP68-25		50	—	—	$V_{CE} = 10\text{V}, I_C = 5.0\text{mA}$ $V_{CE} = 1.0\text{V}, I_C = 1.0\text{A}$ $V_{CE} = 1.0\text{V}, I_C = 500\text{mA}$ $V_{CE} = 1.0\text{V}, I_C = 500\text{mA}$
		DCP68		85	—	375	
		DCP68-25		160	—	375	
Collector-Emitter Saturation Voltage	$V_{CE(SAT)}$	—	—	0.5	V	$I_C = 1.0\text{A}, I_B = 100\text{mA}$	
Base-Emitter Turn-On Voltage	$V_{BE(ON)}$	—	—	1.0	V	$V_{CE} = 1.0\text{V}, I_C = 1.0\text{A}$	
SMALL SIGNAL CHARACTERISTICS							
Current Gain-Bandwidth Product	f_T	—	330	—	MHZ	$I_C = 100\text{mA}, V_{CE} = 5.0\text{V}$ $f = 100\text{MHZ}$	

- Notes:
1. No purposefully added lead.
 2. Diodes Inc.'s "Green" Policy can be found on our website at http://www.diodes.com/products/lead_free/index.php.
 3. Device mounted on FR-4 PCB; pad layout as shown on page 4 or in Diodes Inc. suggested pad layout document AP02001, which can be found on our website at <http://www.diodes.com/datasheets/ap02001.pdf>.
 4. Measured under pulsed conditions. Pulse width = 300 μs . Duty cycle $\leq 2\%$.

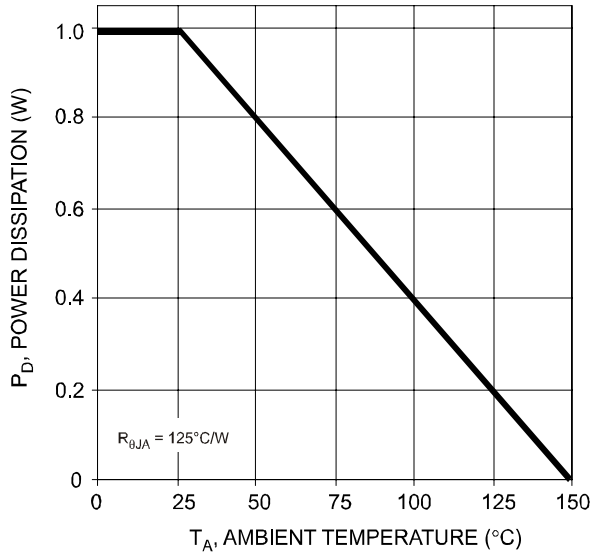

Fig. 1 Power Dissipation vs. Ambient Temperature

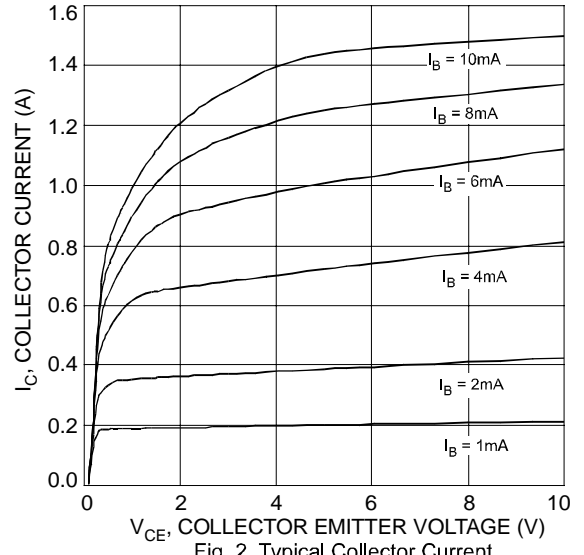

Fig. 2 Typical Collector Current vs. Collector Emitter Voltage

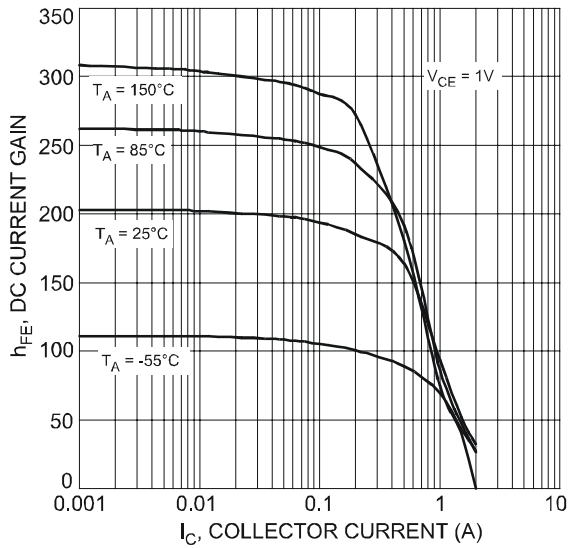

Fig. 3 Typical DC Current Gain vs. Collector Current (DCP68)

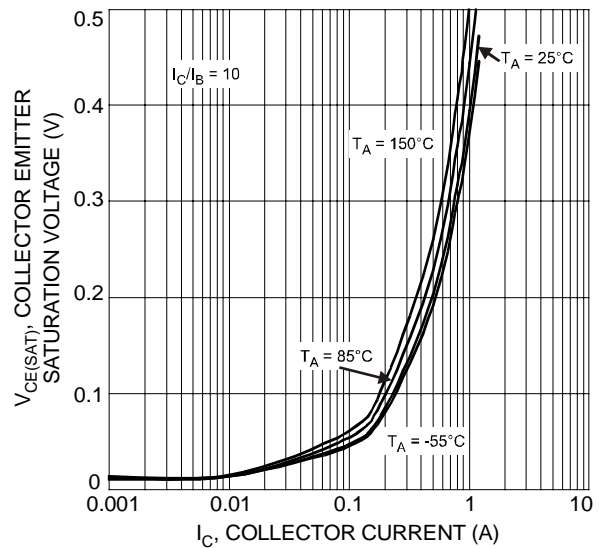

Fig. 4 Typical Collector Emitter Saturation Voltage vs. Collector Current

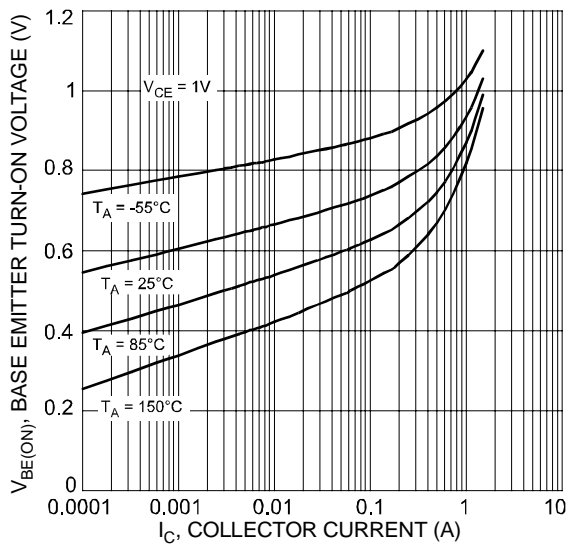

Fig. 5 Typical Base Emitter Turn-On Voltage vs. Collector Current

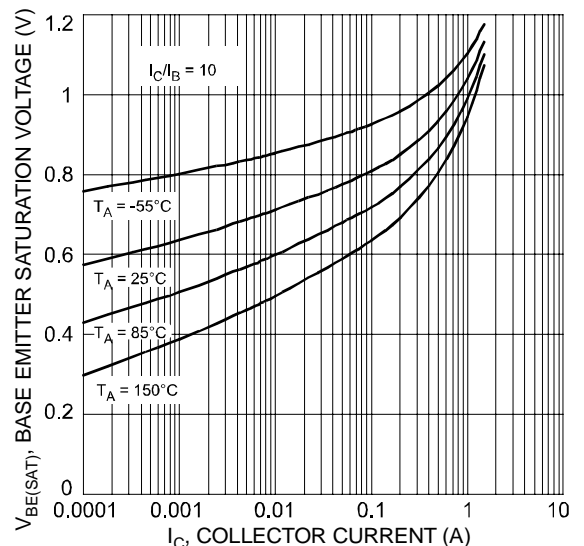

Fig. 6 Typical Base Emitter Saturation Voltage vs. Collector Current

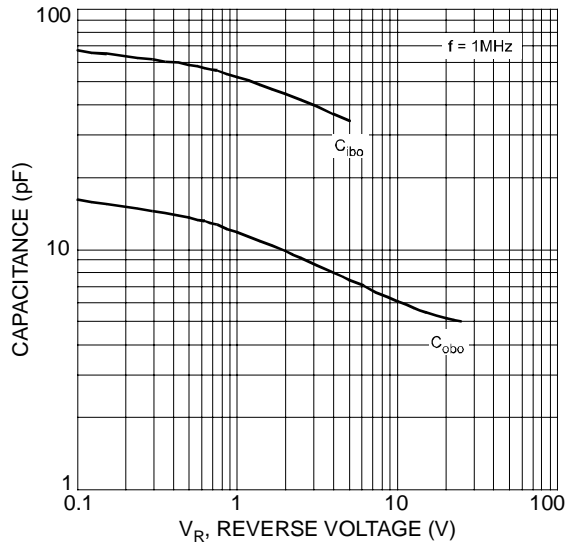

Fig. 7 Typical Capacitance Characteristics

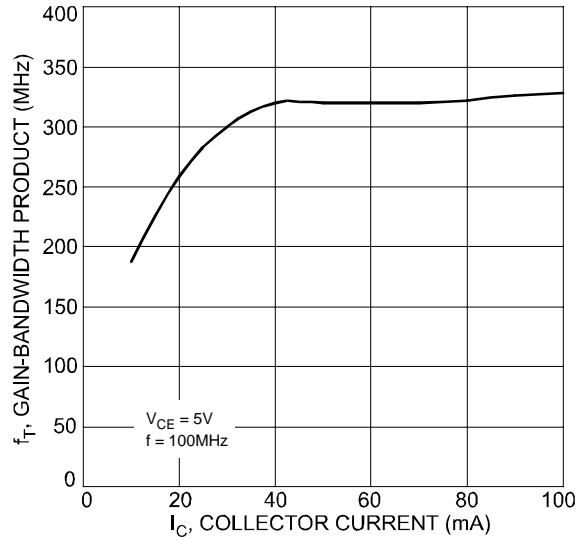

Fig. 8 Typical Gain-Bandwidth Product vs. Collector Current

Ordering Information (Note 5)

Device	Packaging	Shipping
DCP68-13	SOT-223	2500/Tape & Reel
DCP68-25-13	SOT-223	2500/Tape & Reel

Notes: 5. For packaging details, go to our website at <http://www.diodes.com/datasheets/ap02007.pdf>.

Marking Information

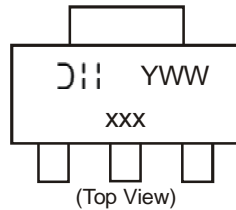

xxx = Product Type Marking Code:
 N12 = DCP68
 N12-25 = DCP68-25
 YWW = Date Code Marking
 Y = Last digit of year ex: 7 = 2007
 WW = Week code 01 - 52

Package Outline Dimensions

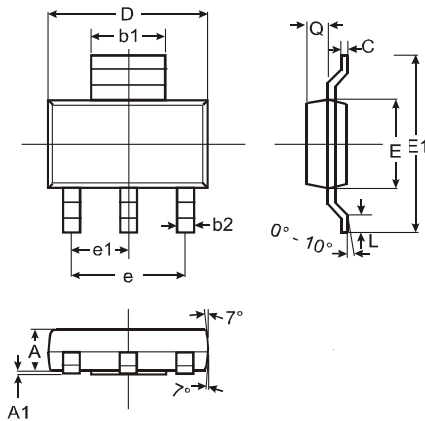

SOT-223			
Dim	Min	Max	Typ
A	1.55	1.65	1.60
A1	0.010	0.15	0.05
b1	2.90	3.10	3.00
b2	0.60	0.80	0.70
C	0.20	0.30	0.25
D	6.45	6.55	6.50
E	3.45	3.55	3.50
E1	6.90	7.10	7.00
e	—	—	4.60
e1	—	—	2.30
L	0.85	1.05	0.95
Q	0.84	0.94	0.89
All Dimensions in mm			

Suggested Pad Layout:

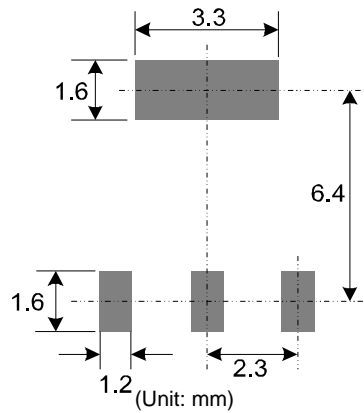

IMPORTANT NOTICE

Diodes Incorporated and its subsidiaries reserve the right to make modifications, enhancements, improvements, corrections or other changes without further notice to any product herein. Diodes Incorporated does not assume any liability arising out of the application or use of any product described herein; neither does it convey any license under its patent rights, nor the rights of others. The user of products in such applications shall assume all risks of such use and will agree to hold Diodes Incorporated and all the companies whose products are represented on our website, harmless against all damages.

LIFE SUPPORT

Diodes Incorporated products are not authorized for use as critical components in life support devices or systems without the expressed written approval of the President of Diodes Incorporated.



LittleDiode supplies new, hard to find or obsolete electronic components and semiconductors all over the world.

With over two million different components listed you are sure to find the part you need.

Feel free to visit us today at our online store:

LittleDiode.com

Looking forward to providing you with the best possible service.