

## Features

- Epitaxial Planar Die Construction
- Ideally Suited for Automated Assembly Processes
- **Lead Free By Design/RoHS Compliant (Note 1)**
- **"Green" Device (Note 2)**
- **Ultra Small Package**

## Mechanical Data

- Case: SOT-963
- Case Material: Molded Plastic, "Green" Molding Compound. UL Flammability Classification Rating 94V-0
- Moisture Sensitivity: Level 1 per J-STD-020D
- Terminals: Finish — Matte Tin annealed over Copper leadframe. Solderable per MIL-STD-202, Method 208
- Marking Information: See Page 3
- Ordering Information: See Page 3
- Weight: 0.0027 grams (approximate)

SOT-963



Top View

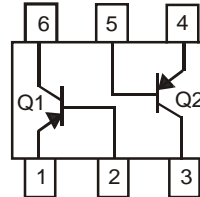

Device Schematic

## Maximum Ratings @ $T_A = 25^\circ\text{C}$ unless otherwise specified

| Characteristic                 | Symbol    | Value | Unit |
|--------------------------------|-----------|-------|------|
| Collector-Base Voltage         | $V_{CBO}$ | -50   | V    |
| Collector-Emitter Voltage      | $V_{CEO}$ | -50   | V    |
| Emitter-Base Voltage           | $V_{EBO}$ | -5    | V    |
| Collector Current - Continuous | $I_C$     | -100  | mA   |
| Base Current                   | $I_B$     | -30   | mA   |

## Thermal Characteristics

| Characteristic                                   | Symbol          | Value       | Unit                      |
|--|-----------------|-------------|---------------------------|
| Power Dissipation (Note 3)                       | $P_D$           | 300         | mW                        |
| Thermal Resistance, Junction to Ambient (Note 3) | $R_{\theta JA}$ | 417         | $^\circ\text{C}/\text{W}$ |
| Operating and Storage Temperature Range          | $T_J, T_{STG}$  | -55 to +150 | $^\circ\text{C}$          |

## Electrical Characteristics @ $T_A = 25^\circ\text{C}$ unless otherwise specified

| Characteristic                       | Symbol        | Min       | Typ   | Max  | Unit          | Test Condition   |  |
|--------------------------------------|---------------|-----------|-------|------|---------------|--|--|
| <b>OFF CHARACTERISTICS (Note 4)</b>  |               |           |       |      |               |  |  |
| Collector-Base Breakdown Voltage     | $V_{(BR)CBO}$ | -50       | —     | —    | V             | $I_C = -10\mu\text{A}, I_E = 0$                                |  |
| Collector-Emitter Breakdown Voltage  | $V_{(BR)CEO}$ | -50       | —     | —    | V             | $I_C = -1\text{mA}, I_B = 0$                                   |  |
| Emitter-Base Breakdown Voltage       | $V_{(BR)EBO}$ | -5        | —     | —    | V             | $I_E = -10\mu\text{A}, I_C = 0$                                |  |
| Collector Cut-Off Current            | $I_{CBO}$     | —         | —     | -0.1 | $\mu\text{A}$ | $V_{CB} = -50\text{V}, I_E = 0$                                |  |
| Emitter Cut-Off Current              | $I_{EBO}$     | —         | —     | -0.1 | $\mu\text{A}$ | $V_{EB} = -5\text{V}, I_C = 0$                                 |  |
| <b>ON CHARACTERISTICS (Note 4)</b>   |               |           |       |      |               |  |  |
| Collector-Emitter Saturation Voltage | $V_{CE(SAT)}$ | —         | -0.15 | -0.3 | V             | $I_C = -100\text{mA}, I_B = -10\text{mA}$                      |  |
| DC Current Gain                      | $h_{FE}$      | DP0150ADJ | 120   | —    | 240           | —  | $V_{CE} = -6\text{V}, I_C = -2\text{mA}$ |
|                                      |               | DP0150BDJ | 200   | —    | 400           |  |  |
| <b>SMALL SIGNAL CHARACTERISTICS</b>  |               |           |       |      |               |  |  |
| Transition Frequency                 | $f_T$         | 80        | —     | —    | MHz           | $V_{CE} = -10\text{V}, I_E = 1\text{mA}$<br>$f = 30\text{MHz}$ |  |
| Output Capacitance                   | $C_{ob}$      | —         | 1.6   | —    | pF            | $V_{CB} = -10\text{V}, I_E = 0,$<br>$f = 1\text{MHz}$          |  |

- Notes:
1. No purposefully added lead.
  2. Diodes Inc.'s "Green" policy can be found on our website at [http://www.diodes.com/products/lead\\_free/index.php](http://www.diodes.com/products/lead_free/index.php).
  3. Device mounted on FR-4 PCB with minimum recommended pad layout.
  4. Measured under pulsed conditions. Pulse width = 300 $\mu\text{s}$ . Duty cycle  $\leq 2\%$

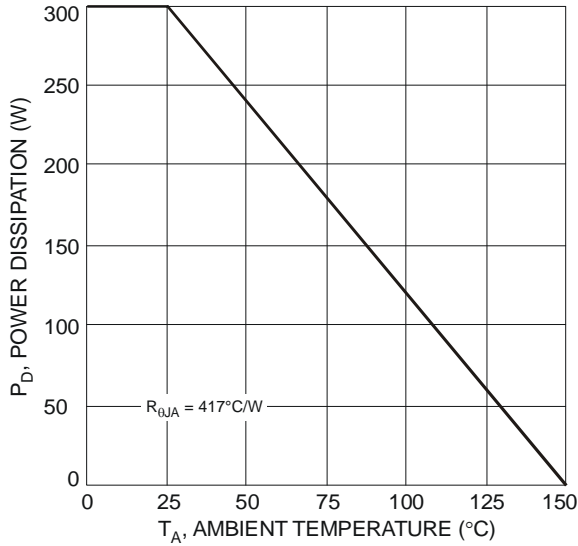

Fig. 1 Power Dissipation vs. Ambient Temperature (Note 3)

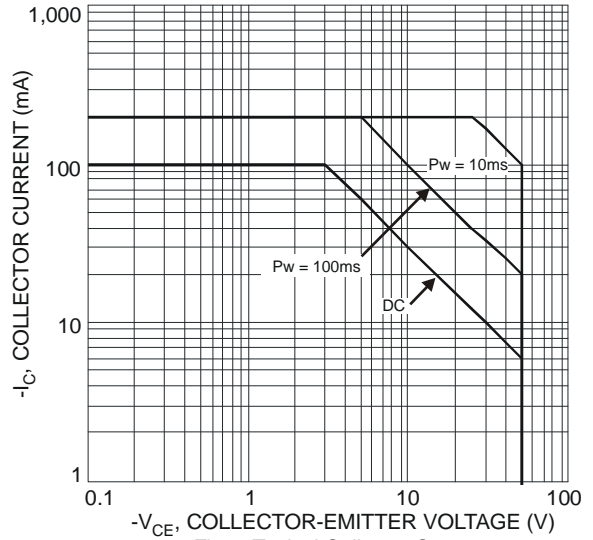

Fig. 2 Typical Collector Current vs. Collector-Emitter Voltage (Note 3)

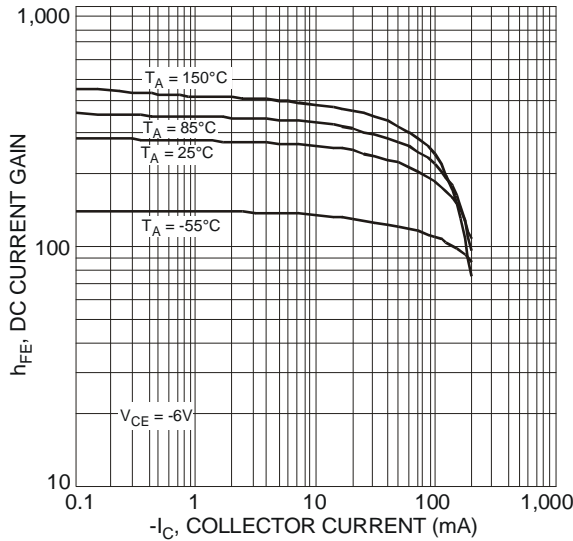

Fig. 3 Typical DC Current Gain vs. Collector Current (DN0150BDJ)

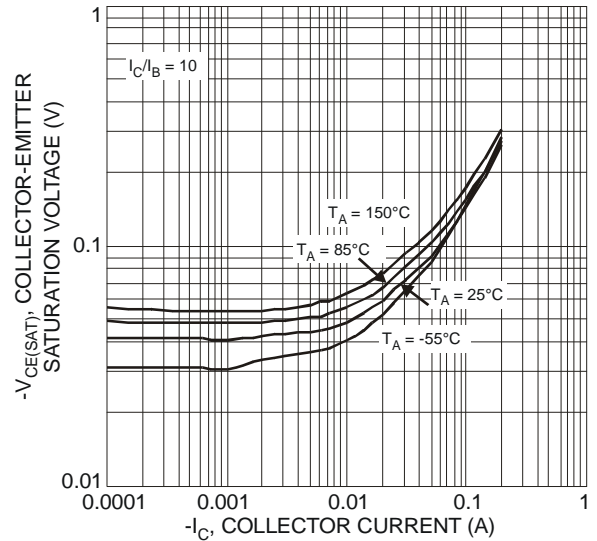

Fig. 4 Typical Collector-Emitter Saturation Voltage vs. Collector Current

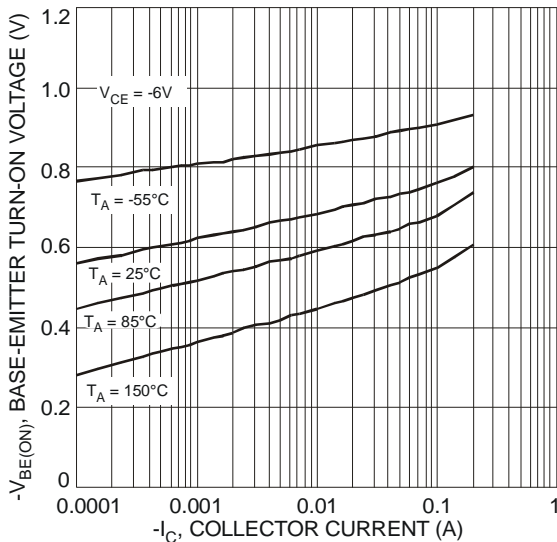

Fig. 5 Typical Base-Emitter Turn-On Voltage vs. Collector Current

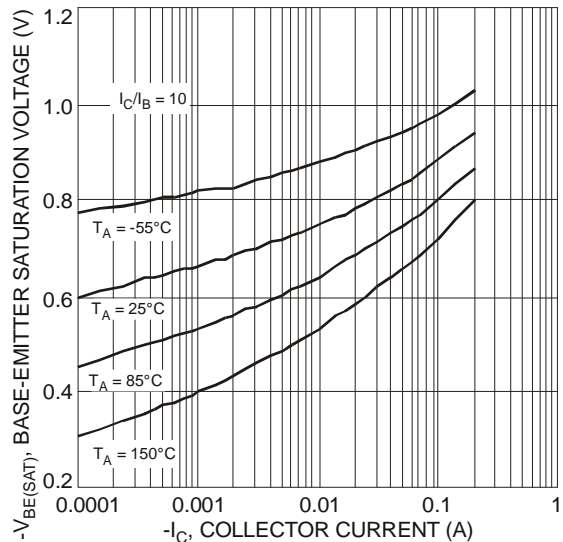

Fig. 6 Typical Base-Emitter Saturation Voltage vs. Collector Current

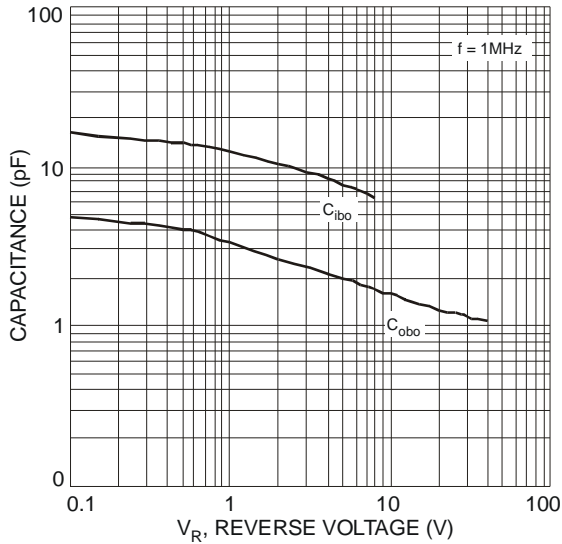

Fig. 7 Typical Capacitance Characteristics

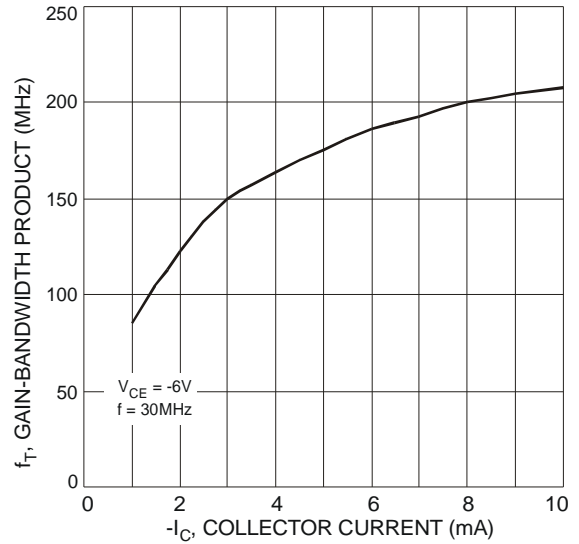

Fig. 8 Typical Gain-Bandwidth Product vs. Collector Current

**Ordering Information** (Note 5)

| Device      | Packaging | Shipping           |
|-------------|-----------|--------------------|
| DP0150ADJ-7 | SOT-963   | 10,000/Tape & Reel |
| DP0150BDJ-7 | SOT-963   | 10,000/Tape & Reel |

Notes: 5. For packaging details, go to our website at <http://www.diodes.com/datasheets/ap02007.pdf>.

**Marking Information**

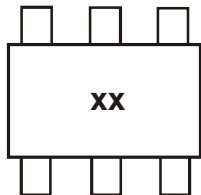

xx= Product Type Marking Code:  
T5 = DP0150ADJ  
T6 = DP0150BDJ

**Package Outline Dimensions**

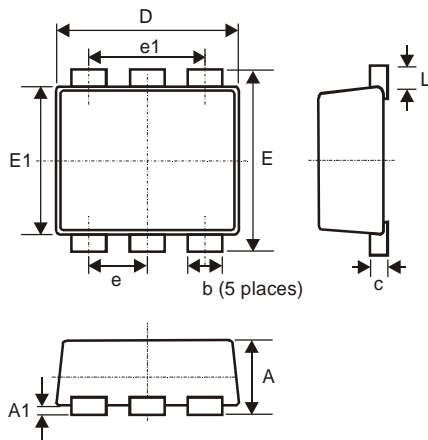

| SOT-963              |          |       |       |
|----------------------|----------|-------|-------|
| Dim                  | Min      | Max   | Typ   |
| A                    | 0.40     | 0.50  | 0.45  |
| A1                   | 0        | 0.05  | -     |
| c                    | 0.077    | 0.177 | 0.127 |
| D                    | 0.95     | 1.05  | 1.00  |
| E                    | 0.95     | 1.05  | 1.00  |
| E1                   | 0.75     | 0.85  | 0.80  |
| L                    | 0.05     | 0.15  | 0.10  |
| b                    | 0.10     | 0.20  | 0.15  |
| e                    | 0.35 Typ |       |       |
| e1                   | 0.70 Typ |       |       |
| All Dimensions in mm |          |       |       |

**IMPORTANT NOTICE**

DIODES INCORPORATED MAKES NO WARRANTY OF ANY KIND, EXPRESS OR IMPLIED, WITH REGARDING TO THIS DOCUMENT, INCLUDING, BUT NOT LIMITED TO, THE IMPLIED WARRANTIES OF MERCHANTABILITY AND FITNESS FOR A PARTICULAR PURPOSE (AND THEIR EQUIVALENTS UNDER THE LAWS OF ANY JURISDICTION).

Diodes Incorporated and its subsidiaries reserve the right to make modifications, enhancements, improvements, corrections or other changes without further notice to this document and any product described herein. Diodes Incorporated does not assume any liability arising out of the application or use of this document or any product described herein; neither does Diodes Incorporated convey any license under its patent or trademark rights, nor the rights of others. Any Customer or user of this document or products described herein in such applications shall assume all risks of such use and will agree to hold Diodes Incorporated and all the companies whose products are represented on Diodes Incorporated website, harmless against all damages.

Diodes Incorporated does not warrant or accept any liability whatsoever in respect of any products purchased through unauthorized sales channel. Should Customers purchase or use Diodes Incorporated products for any unintended or unauthorized application, Customers shall indemnify and hold Diodes Incorporated and its representatives harmless against all claims, damages, expenses, and attorney fees arising out of, directly or indirectly, any claim of personal injury or death associated with such unintended or unauthorized application.

Products described herein may be covered by one or more United States, international or foreign patents pending. Product names and markings noted herein may also be covered by one or more United States, international or foreign trademarks.

**LIFE SUPPORT**

Diodes Incorporated products are specifically not authorized for use as critical components in life support devices or systems without the express written approval of the Chief Executive Officer of Diodes Incorporated. As used herein:

A. Life support devices or systems are devices or systems which:

1. are intended to implant into the body, or
2. support or sustain life and whose failure to perform when properly used in accordance with instructions for use provided in the labeling can be reasonably expected to result in significant injury to the user.

B. A critical component is any component in a life support device or system whose failure to perform can be reasonably expected to cause the failure of the life support device or to affect its safety or effectiveness.

Customers represent that they have all necessary expertise in the safety and regulatory ramifications of their life support devices or systems, and acknowledge and agree that they are solely responsible for all legal, regulatory and safety-related requirements concerning their products and any use of Diodes Incorporated products in such safety-critical, life support devices or systems, notwithstanding any devices- or systems-related information or support that may be provided by Diodes Incorporated. Further, Customers must fully indemnify Diodes Incorporated and its representatives against any damages arising out of the use of Diodes Incorporated products in such safety-critical, life support devices or systems.

Copyright © 2009, Diodes Incorporated

[www.diodes.com](http://www.diodes.com)



LittleDiode supplies new, hard to find or obsolete electronic components and semiconductors all over the world.

With over two million different components listed you are sure to find the part you need.

Feel free to visit us today at our online store:

[LittleDiode.com](http://LittleDiode.com)

Looking forward to providing you with the best possible service.