

**100V NPN LOW SAT MEDIUM POWER TRANSISTOR
POWERDI[®]5**

Features

- 43% smaller than SOT223; 60% smaller than TO252
- Maximum height just 1.1mm
- Rated up to 3.2W
- $BV_{CEO} > 100V$
- Maximum continuous current $I_C = 6A$
- Low Saturation voltage
- **Totally Lead-Free & Fully RoHS compliant (Note 1)**
- **Halogen and Antimony Free. "Green" Device (Note 2)**

Applications

- Motor Drive
- Regulator circuit

Mechanical Data

- Case: POWERDI5
- Case Material: Molded Plastic, "Green" Molding Compound. UL Flammability Classification Rating 94V-0
- Moisture Sensitivity: Level 1 per J-STD-020
- Terminals: Finish – Matte Tin annealed over Copper leadframe. Solderable per MIL-STD-202, Method 208 
- Weight: 0.093 grams (approximate)

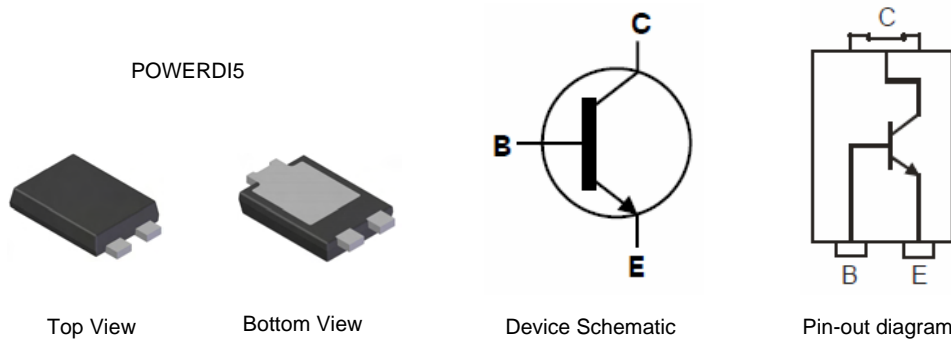



Ordering Information (Note 3)

Part Number	Case	Packaging
DXT2011P5-13	POWERDI5	5000/Tape & Reel

- Notes:
1. No purposely added lead. Fully EU Directive 2002/95/EC (RoHS) & 2011/65/EU (RoHS 2) compliant.
 2. Halogen and Antimony free "Green" products are defined as those which contain <900ppm bromine, <900ppm chlorine (<1500ppm total Br + Cl) and <1000ppm antimony compounds.
 3. For packaging details, go to our website at <http://www.diodes.com>.

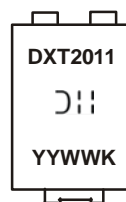
Marking Information



DXT2011 = Product Type Marking Code
 = Manufacturers' Code Marking
 K = Factory Designator
 YYWW = Date Code Marking
 YY = Last Two Digits of Year (ex: 09 for 2009)
 WW = Week code (01 to 53)

Maximum Ratings @ $T_A = 25^\circ\text{C}$ unless otherwise specified

Characteristic	Symbol	Value	Unit
Collector-Base Voltage	V_{CBO}	200	V
Collector-Emitter Voltage	V_{CEO}	100	V
Emitter-Base Voltage	V_{EBO}	7	V
Continuous Collector Current	I_C	6	A
Peak Pulse Current	I_{CM}	10	A

Thermal Characteristics @ $T_A = 25^\circ\text{C}$ unless otherwise specified

Characteristic	Symbol	Value	Unit
Power Dissipation	P_D	3.2	W
		1.7	
		0.74	
Thermal Resistance, Junction to Ambient	$R_{\theta JA}$	39	$^\circ\text{C/W}$
		75	
		169	
Thermal Resistance, Junction to Collector Terminal	$R_{\theta JT}$	5.6	$^\circ\text{C/W}$
Operating and Storage Temperature Range	T_J, T_{STG}	-55 to +150	$^\circ\text{C}$

- Notes:
4. Device mounted on FR-4 PCB, single sided 2 oz. copper, collector pad dimensions 50mm x 50mm.
 5. Device mounted on FR-4 PCB, single sided 1 oz. copper, collector pad dimensions 25mm x 25mm.
 6. Device mounted on FR-4 PCB, single sided 1 oz. copper, minimum recommended pad layout.

Thermal Characteristics

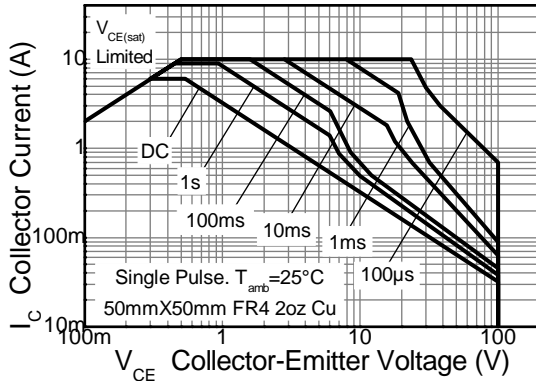

Safe Operating Area

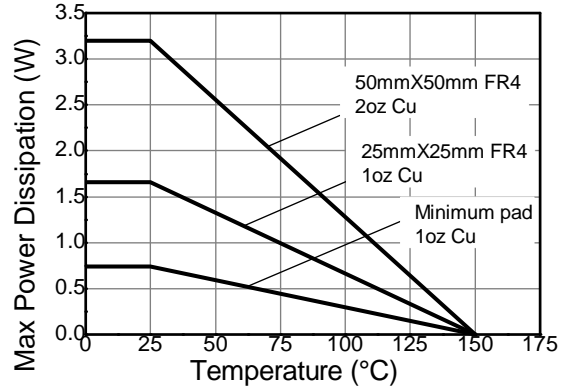

Derating Curve

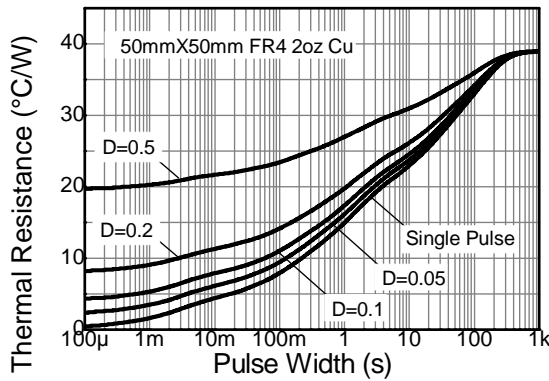

Transient Thermal Impedance

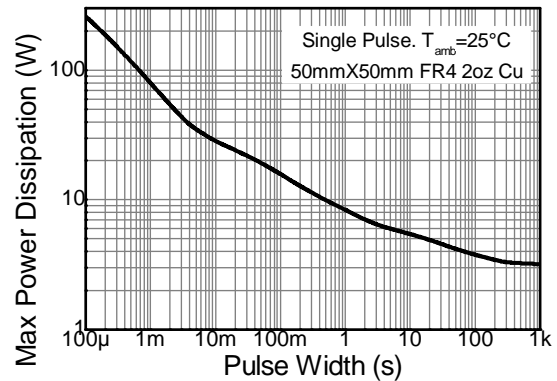

Pulse Power Dissipation

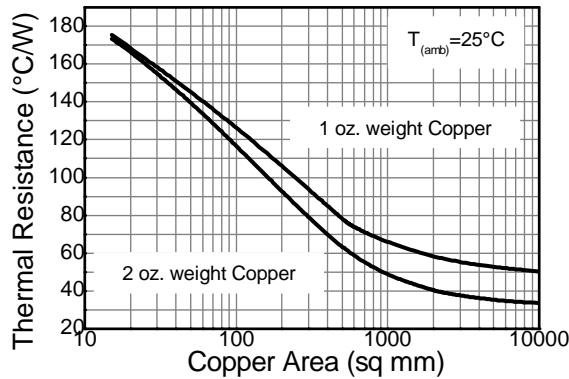

Thermal Resistance vs. Cu Area

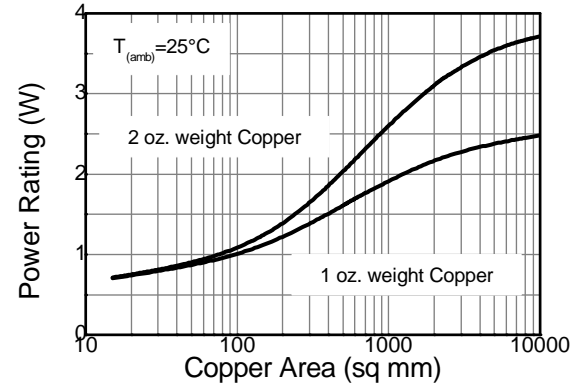

Power Rating vs. Cu Area

Electrical Characteristics @T_A = 25°C unless otherwise specified

Characteristic	Symbol	Min	Typ	Max	Unit	Test Condition
Collector-Base Breakdown Voltage	BV _{CBO}	200	235	—	V	I _C = 100μA
Collector-Emitter Breakdown Voltage (Note 7)	BV _{CEO}	100	115	—	V	I _C = 10mA
Emitter-Base Breakdown Voltage	BV _{EBO}	7	8.1	—	V	I _E = 100μA
Collector Cutoff Current	I _{CBO}	—	—	20 0.5	nA μA	V _{CB} = 150V V _{CB} = 150V, T _{amb} = 100 °C
Collector Cutoff Current	I _{CER} R ≤ 1kΩ	—	—	20 0.5	nA μA	V _{CB} = 150V V _{CB} = 150V, T _{amb} = 100 °C
Emitter Cutoff Current	I _{EBO}	—	—	10	nA	V _{EB} = 6V
Collector-Emitter Saturation Voltage (Note 7)	V _{CE(sat)}	—	21 50 95 180	35 65 125 220	mV	I _C = 0.1A, I _B = -5mA I _C = 1A, I _B = 100mA I _C = 2A, I _B = 100mA I _C = 5A, I _B = 500mA
Base-Emitter Saturation Voltage (Note 7)	V _{BE(sat)}	—	1020	1120	mV	I _C = 5A, I _B = 500mA
Base-Emitter Turn-On Voltage (Note 7)	V _{BE(on)}	—	920	1000	mV	V _{CE} = 2V, I _C = 5A
DC Current Gain (Note 7)	h _{FE}	100 100 30 10	— — — —	— 300 — —	—	V _{CE} = 2V, I _C = 10mA V _{CE} = 2V, I _C = 2A V _{CE} = 2V, I _C = 5A V _{CE} = 2V, I _C = 10A
Transition Frequency	f _T	—	130	—	MHz	V _{CE} = 10V, I _C = 100mA, f = 50MHz
Output Capacitance	C _{obo}	—	26	—	pF	V _{CB} = 10V, f = 1MHz
Switching Times	t _{on} t _{off}	— —	41 1010	— —	ns	V _{CC} = 10V, I _C = 1A, I _{B1} = I _{B2} = 100mA

Notes: 7. Pulse Test: Pulse width ≤ 300μs. Duty cycle ≤ 2.0%.

Typical Characteristic

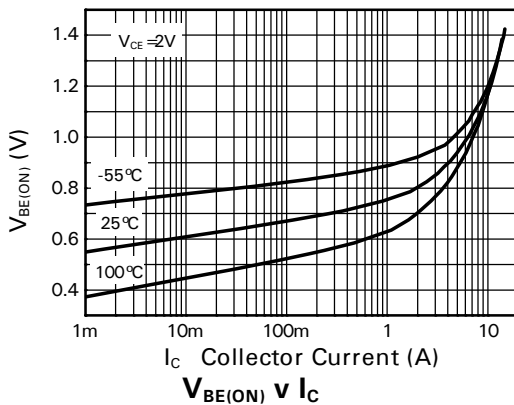
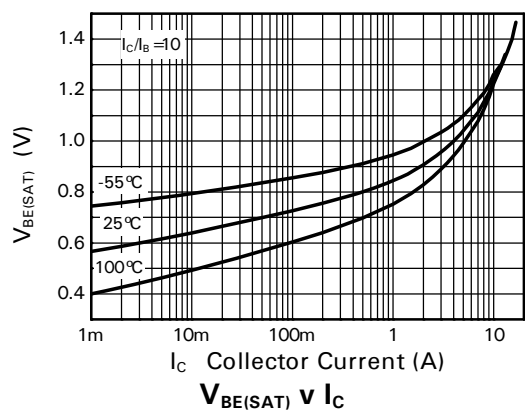
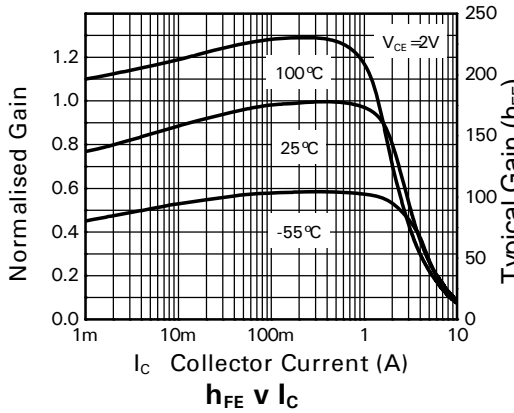
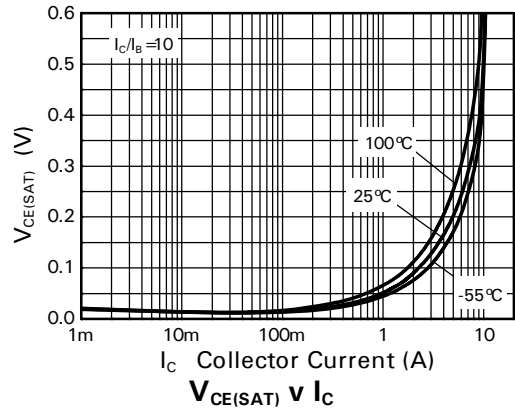
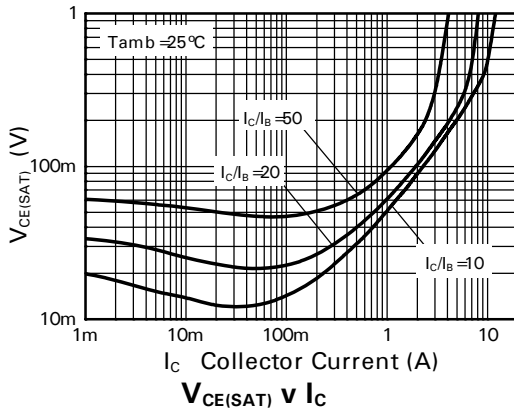

Package Outline Dimensions

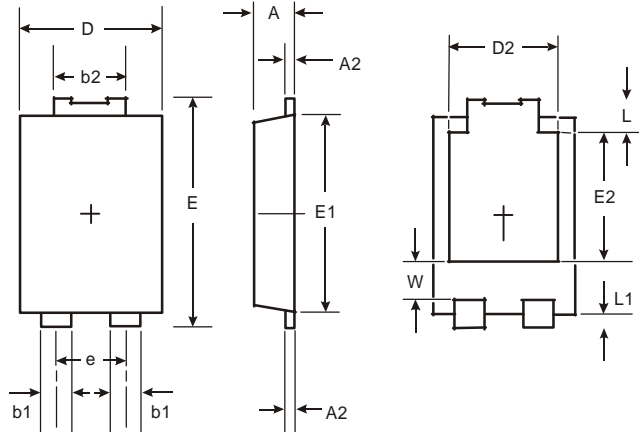

POWERDI5		
Dim	Min	Max
A	1.05	1.15
A2	0.33	0.43
b1	0.80	0.99
b2	1.70	1.88
D	3.90	4.05
D2	3.054 Typ	
E	6.40	6.60
e	1.84 Typ	
E1	5.30	5.45
E2	3.549 Typ	
L	0.75	0.95
L1	0.50	0.65
W	1.10	1.41
All Dimensions in mm		

Suggested Pad Layout

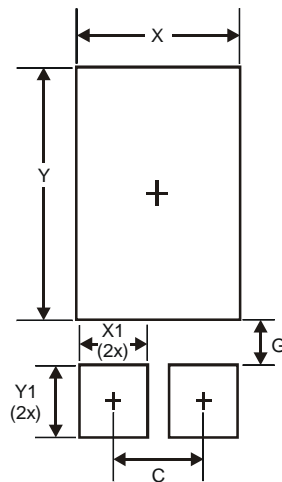

Dimensions	Value (in mm)
C	1.840
G	0.852
X	3.360
X1	1.390
Y	4.860
Y1	1.400

IMPORTANT NOTICE

DIODES INCORPORATED MAKES NO WARRANTY OF ANY KIND, EXPRESS OR IMPLIED, WITH REGARDS TO THIS DOCUMENT, INCLUDING, BUT NOT LIMITED TO, THE IMPLIED WARRANTIES OF MERCHANTABILITY AND FITNESS FOR A PARTICULAR PURPOSE (AND THEIR EQUIVALENTS UNDER THE LAWS OF ANY JURISDICTION).

Diodes Incorporated and its subsidiaries reserve the right to make modifications, enhancements, improvements, corrections or other changes without further notice to this document and any product described herein. Diodes Incorporated does not assume any liability arising out of the application or use of this document or any product described herein; neither does Diodes Incorporated convey any license under its patent or trademark rights, nor the rights of others. Any Customer or user of this document or products described herein in such applications shall assume all risks of such use and will agree to hold Diodes Incorporated and all the companies whose products are represented on Diodes Incorporated website, harmless against all damages.

Diodes Incorporated does not warrant or accept any liability whatsoever in respect of any products purchased through unauthorized sales channel. Should Customers purchase or use Diodes Incorporated products for any unintended or unauthorized application, Customers shall indemnify and hold Diodes Incorporated and its representatives harmless against all claims, damages, expenses, and attorney fees arising out of, directly or indirectly, any claim of personal injury or death associated with such unintended or unauthorized application.

Products described herein may be covered by one or more United States, international or foreign patents pending. Product names and markings noted herein may also be covered by one or more United States, international or foreign trademarks.

LIFE SUPPORT

Diodes Incorporated products are specifically not authorized for use as critical components in life support devices or systems without the express written approval of the Chief Executive Officer of Diodes Incorporated. As used herein:

A. Life support devices or systems are devices or systems which:

1. are intended to implant into the body, or
2. support or sustain life and whose failure to perform when properly used in accordance with instructions for use provided in the labeling can be reasonably expected to result in significant injury to the user.

B. A critical component is any component in a life support device or system whose failure to perform can be reasonably expected to cause the failure of the life support device or to affect its safety or effectiveness.

Customers represent that they have all necessary expertise in the safety and regulatory ramifications of their life support devices or systems, and acknowledge and agree that they are solely responsible for all legal, regulatory and safety-related requirements concerning their products and any use of Diodes Incorporated products in such safety-critical, life support devices or systems, notwithstanding any devices- or systems-related information or support that may be provided by Diodes Incorporated. Further, Customers must fully indemnify Diodes Incorporated and its representatives against any damages arising out of the use of Diodes Incorporated products in such safety-critical, life support devices or systems.

Copyright © 2012, Diodes Incorporated

www.diodes.com



LittleDiode supplies new, hard to find or obsolete electronic components and semiconductors all over the world.

With over two million different components listed you are sure to find the part you need.

Feel free to visit us today at our online store:

LittleDiode.com

Looking forward to providing you with the best possible service.