

# Channel Photomultipliers

## Overview and Specifications

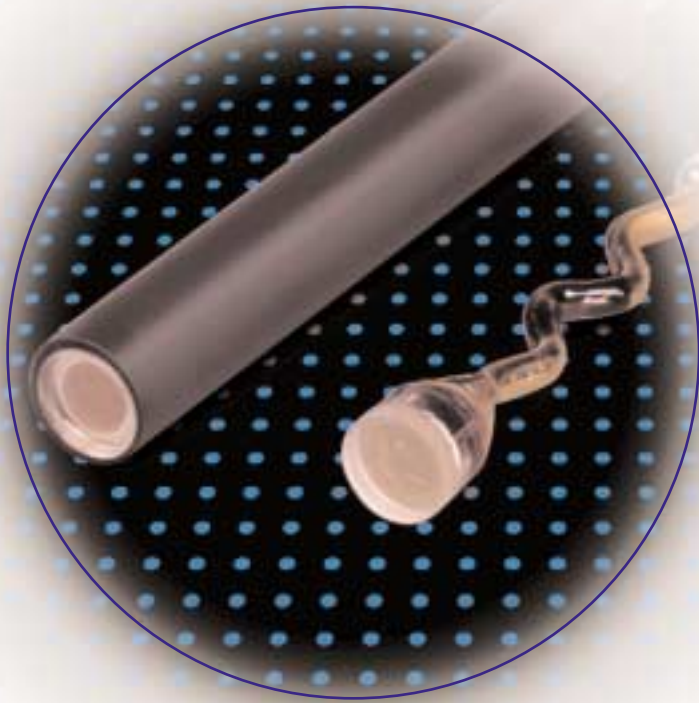

# CHANNEL PHOTOMULTIPLIER

## CPM

### Features

- Ultra high anode sensitivity up to  $10^7$  A/W
- Extremely low dark current, typically  $3\text{pA}$  @  $10^8$  gain
- Very low equivalent noise input (down to  $10^{-17}$  W)
- Very high stability in dark current (no "bursts")
- High gain exceeding  $10^8$
- Very high dynamic range
- Compact dimensions
- Wide spectral response through multiple window materials
- High resolution
- Fast response time
- High immunity to magnetic fields
- Rugged design

### Description

PerkinElmer Optoelectronics, formerly EG&G Optoelectronics, is pleased to introduce the Channel Photomultiplier (CPM), a new ultra high sensitivity optical detector which replaces conventional photomultipliers (PMTs) and avalanche photo diodes (APDs). This device uses a unique detector principle, resulting in a compact design with ultra high gain, high dynamic range, extremely low dark current, and fast response.

This high-performance detector offers fundamental advantages for analytical instrumentation applications such as emission spectroscopy, fluorescence, atomic absorption spectroscopy, and bio and chemo luminescence. The CPM also delivers important advantages in life science products, industrial and medical equipment, and high-energy physics.

When compared to conventional PMTs, the CPM improves anode sensitivity by one order of magnitude, while lowering dark current by one to two orders of magnitude. The noise level shows extreme stability over time, with no "bursts." The extremely low dark current results in a higher dynamic range than conventional PMTs and extends detectable limits for many applications.

The CPM can be used in analog-DC mode, single photon counting mode, and in nuclear spectroscopy (when coupled to scintillation materials like BGO, LSO, NaI, etc.). PerkinElmer Optoelectronics offers a choice of window materials and photocathodes to cover the spectrum from 115 nm (UV range) to 900 nm (NIR).

The new detector is a small, head-on type with a total diameter of 10.5 mm including encapsulation. PerkinElmer Optoelectronics also offers custom configurations for specific applications.

## PRINCIPLE OF OPERATION

### Principle of Operation

The CPM, like conventional photomultiplier tubes, converts a very low light level into photoelectrons by a semitransparent photocathode deposited on the inner surface of the entrance window. On their way from the cathode to the anode the photoelectrons pass through a narrow, semiconductive channel. Each time the electrons hit the inner wall of the curved channel, multiple secondary electrons are emitted. This effect occurs multiple times along the path, leading to an avalanche effect with a gain exceeding  $10^8$ . The curved shape of the glass tube improves the multiplication effect.

### Physical Specification

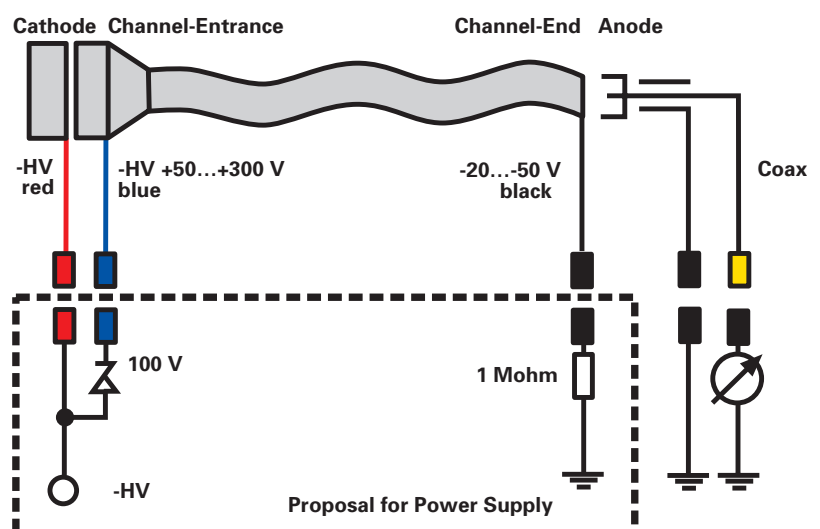

# MAIN FEATURES

## Compact Size

The CPM is one of the smallest head-on type detectors, with a 10.5 mm diameter including encapsulation. The photocathode has a useful diameter of more than 5 mm. The tube is smaller, easier to use, and more rugged than discrete dynode types. Only a single high voltage supply of up to 3000 volts is necessary; no external voltage divider network is required. A variety of different sizes will be available soon (1/2" and 3/4").



Unpotted 1/3 inch Channel Photomultiplier

**Fig. 1: Typical current amplification**

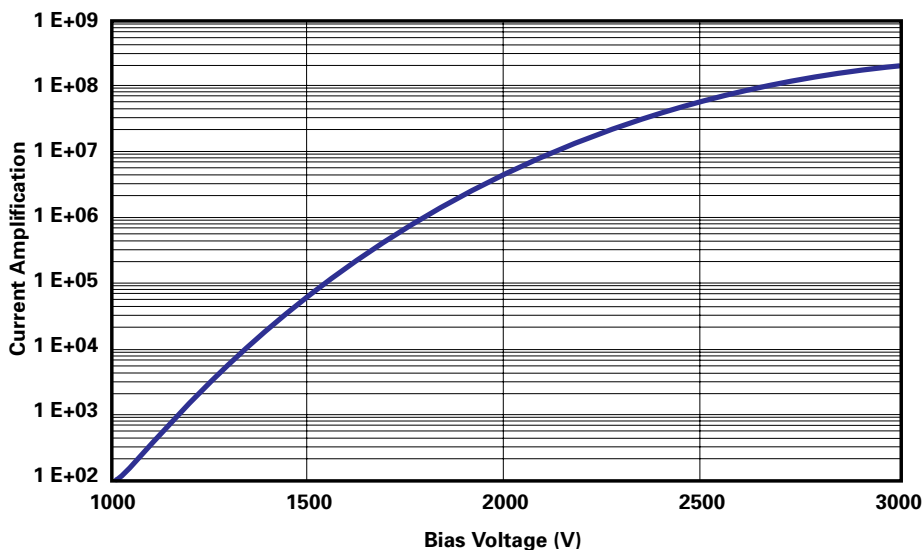

## Ultra high anode sensitivity

At the maximum bias voltage of 3000 V, gains can exceed  $10^8$ . At 2400 V, anode sensitivity is typically  $3 \times 10^6$  A/W at a wavelength of 410 nm with a bi-alkali photocathode. This performance surpasses conventional PMTs by one to two orders of magnitude and beats APDs by approximately five orders of magnitude (Fig. 1).

**Fig. 2: Typical anode dark current**

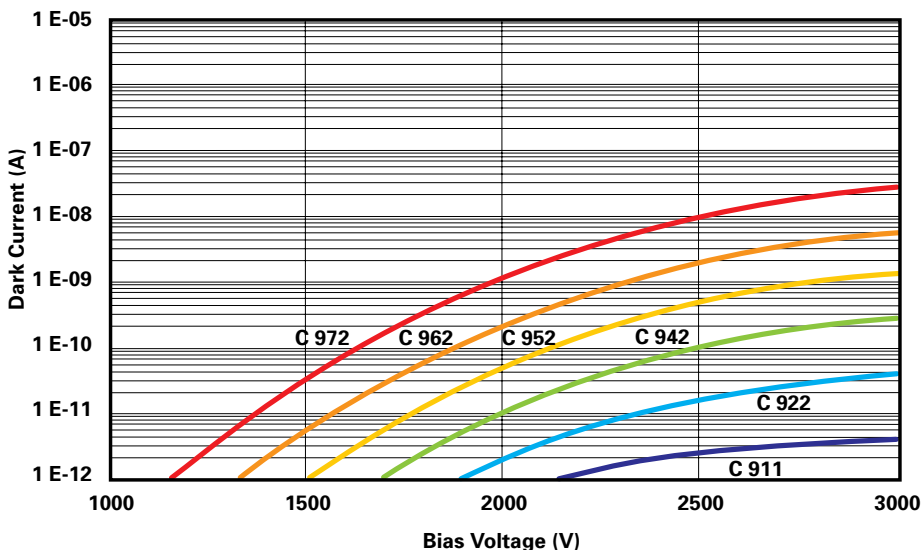

## Extremely low dark current

The electron multiplication in the channel is virtually silent, so dark current depends only on the photocathode material, leakage currents are negligible. Bi-alkali photocathodes exhibit typical dark count rates of 10 cps at a gain of  $3 \times 10^8$ , while UV cathodes have dark count rates below 1 cps. In analog DC mode, the typical dark noise for a bi-alkali photocathode is 20 pA at a gain of  $10^7$ . In general, the noise level of the PerkinElmer Optoelectronics CPM is one to two orders of magnitude lower than dynode PMTs, resulting in a significantly higher dynamic range (Fig.2).

## High stability in dark current level

As a result of the semiconductive inner surface of the CPM, no charge-up effects occur at the glass surface. This results in a very high stability of the dark current level over time, with no sudden changes (bursts). The semiconductive surface also causes high-light recovery times to be extremely small.

Fig. 3: Typical photo electron spectrum

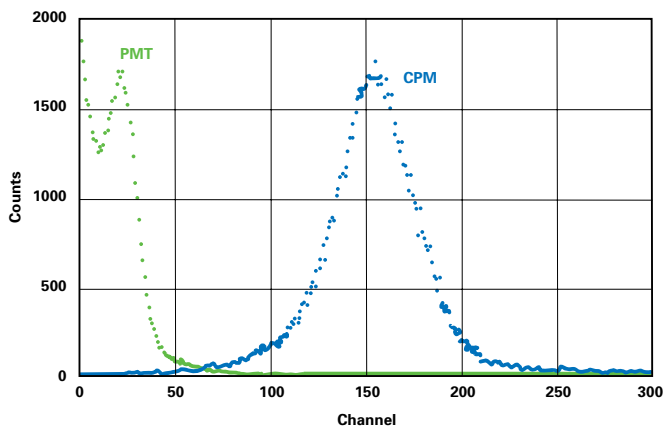

Fig. 4.1: Typical spectral response

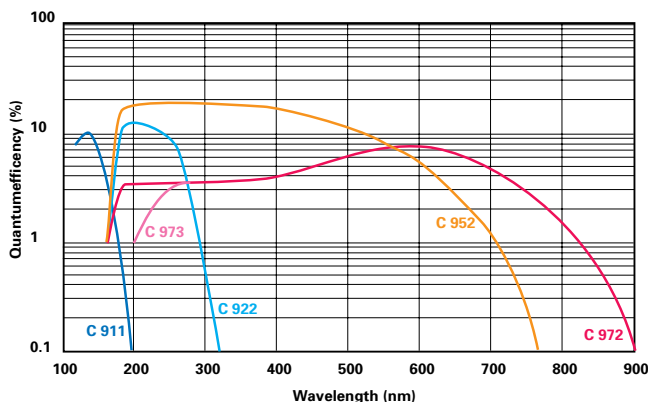
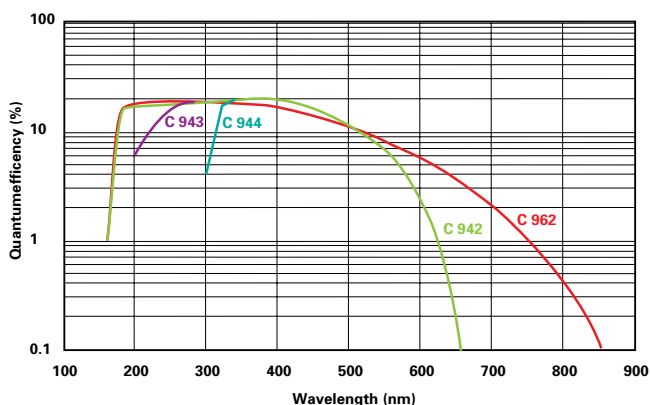

Fig. 4.2: Typical spectral response



EU  
PerkinElmer Optoelectronics GmbH  
Heimann Opto  
65020 Wiesbaden, Germany  
PO-Box 3007  
<http://www.perkinelmer.com/opto>

USA  
PerkinElmer Optoelectronics  
2175 Mission College Blvd.  
Santa Clara, CA 95054  
Tel. ++1 (408) 565 - 0830  
Fax ++1 (408) 565 - 0703  
<http://www.perkinelmer.com/opto>

## Excellent photon counting resolution

At gains exceeding  $10^7$  the single photo electron pulse is perfectly separated from the electrical noise, due to a saturation effect of the channel. The CPM exhibits single photon resolution with excellent peak to valley ratios. Fig. 3 shows the single photo electron spectrum taken from a multi-channel analyzer compared to a conventional photomultiplier (Fig. 3).

## Choice of entrance window

The CPM is available with different window materials, which are:

MgF<sub>2</sub>, Quartz, UV-glass, and Borosilicate glass. The combination of different photocathodes and entrance windows results in a spectral range from 115 nm to 900 nm. Other window materials and photocathode combinations are available on a custom basis (Fig. 4.1 and 4.2).

## Available related products

- High Voltage supply  
CHV 30N (supplies 1 CPM, negative output voltage),  
CHV 30P (supplies 1 CPM, positive output voltage),  
J4-3N (supplies 10 to 15 CPMs)
- CPM Modules  
MP900-series: Photoncounting module with  
TTL output, including CPM,  
electronic and high voltage  
MD900-series: DC module including high  
voltage supply, amplifier,  
I/U converter, output 0 to 10 V,  
bandwidth 1kHz  
MH900-series: High voltage module,  
including CPM and  
high voltage power supply

## • CPM Formats

- $\frac{1}{3}$ " C900-series
- $\frac{1}{2}$ " C1300-series
- $\frac{3}{4}$ " C1900-series

**Datasheets on request**

# CPM C900 Series

## 1/3" CPM Channel Photomultipliers

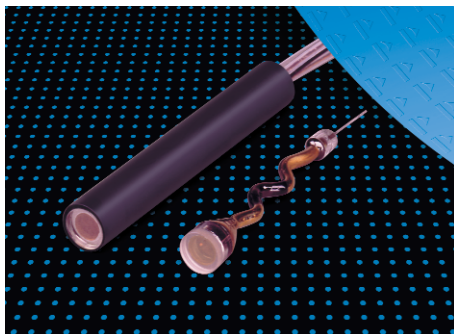

- High Sensitivity Optical Detector
- Extremely High Gain
- Ultra Low Noise
- 1/3 Inch, Head-On Type

### Technical Specifications

Type	Spectral response (nm)	Photocathode material	Min. useful area (mm)	Window material	Electron multiplication	Supply voltage (V)	Current amplification	Dark current (pA)	Equivalent Noise Input, ENI (W)	Bias current (µA)	Max. linear anode current	Max. anode current*	Response time Rise time (ns) Pulse width / FWHM (ns)	Special types for Photon Counting	Supply voltage (V)	Single photo electron gain	Dark counts (cps)	Peak to valley	Max. ambient temperature (°C)
C911	115-200	CsI	5	MgF <sub>2</sub>	Channel Electron Multiplier	2400 (max. 3000 )	6x10 <sup>5</sup>	2	1x10 <sup>-17</sup>	50	(DC linearity limit) 10% of bias current	10 µA (max. 30 sec.)	3 6	C911P	3000 (max. 3000 )	3x10 <sup>8</sup>	10:1	50	
C921	115-320	CsTe		MgF <sub>2</sub>			1x10 <sup>6</sup>	10	1x10 <sup>-17</sup>					C921P					1
C922	165-320	CsTe		Quartz			1x10 <sup>6</sup>	10	1x10 <sup>-17</sup>					C922P					1
C942	165-650	Bial kali		Quartz			3x10 <sup>6</sup>	80	1x10 <sup>-17</sup>					C942P					10
C943	185-650			UV glass			3x10 <sup>6</sup>	80	1x10 <sup>-17</sup>					C943P					10
C944	300-650	Low noise Multialk.		Borosil.			3x10 <sup>6</sup>	80	1x10 <sup>-17</sup>					C944P					10
C952	165-750			Quartz			3x10 <sup>6</sup>	250	2.5x10 <sup>-17</sup>					C952P					40
C953	185-750	UV glass		3x10 <sup>6</sup>			250	2.5x10 <sup>-17</sup>	C953P					40					
C962	165-850	Multialk.		Quartz			2x10 <sup>6</sup>	1000	4x10 <sup>-17</sup>					C962P					100
C963	185-850			UV glass			2x10 <sup>6</sup>	1000	4x10 <sup>-17</sup>					C963P					100
C972	165-900	Extend. red Multialk.		Quartz			2x10 <sup>6</sup>	5000	1.5x10 <sup>-16</sup>					C972P					500
C973	185-900			UV glass			2x10 <sup>6</sup>	5000	1.5x10 <sup>-16</sup>					C973P					500
C982	165-650	Low noise Bialk.		Quartz			3x10 <sup>6</sup>	25	6x10 <sup>-18</sup>					C982P					3
C983	185-650			UV glass			3x10 <sup>6</sup>	25	6x10 <sup>-18</sup>					C983P					3

### Dimensions (mm)

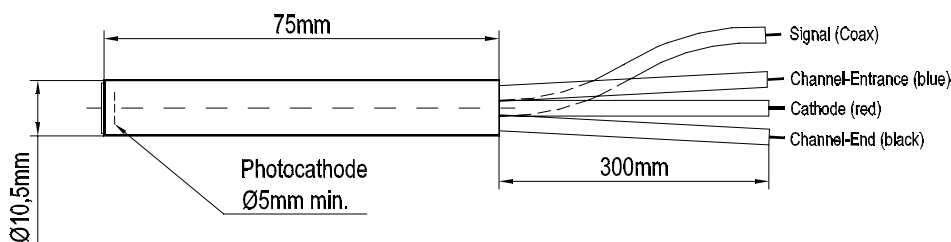

**CPM C900 Series**  
**1/3" CPM Channel Photomultipliers**

**CPM C900 Performance Specifications**

**Spectral response**

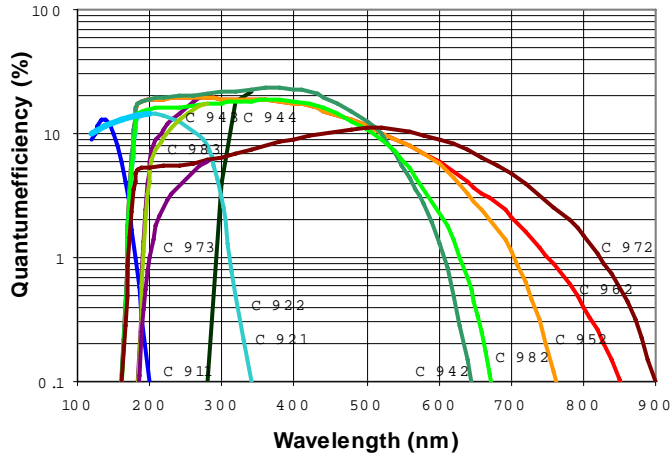

**Current Amplification**

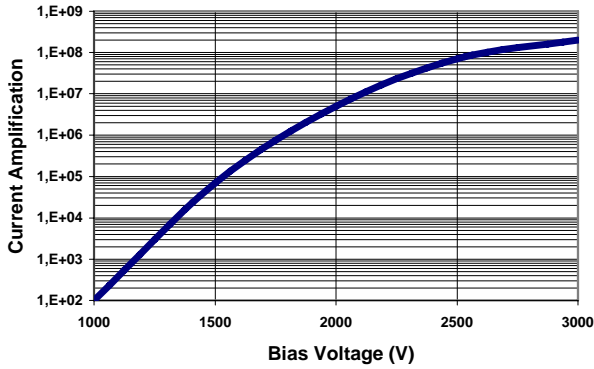

**Dark Current**

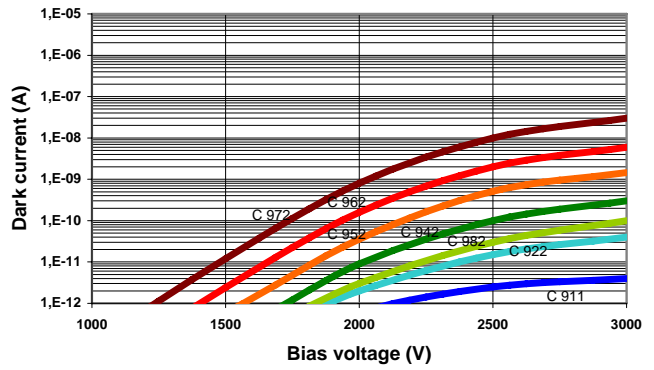

**Equivalent Noise Input**

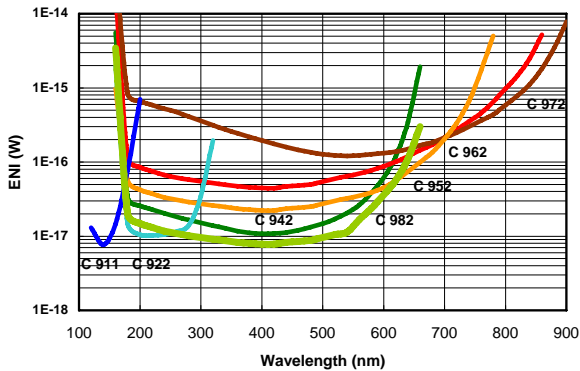

**Magnetic Field Effects**

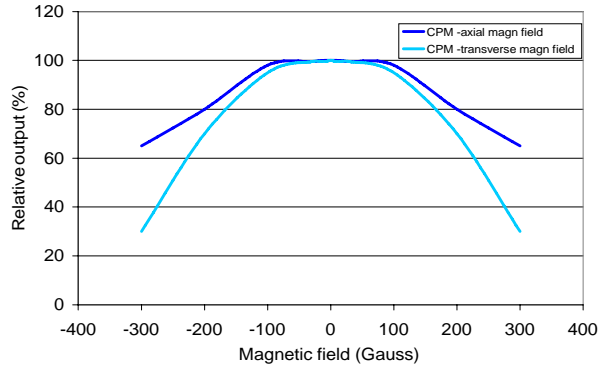

**CAUTION: High Voltage Warning!**

This product is operated at high voltage. Extreme care must be taken to ensure operator safety and to avoid damage to other instruments. Avoid direct contact with the photomultiplier when high voltage is applied. Avoid placing conductive material close to the cathode.  
 All given values are nominal/typical @ 20 °C ambient temperature; specifications subject to change without notice.

# CPM C1300 Series

## 1/2" CPM Channel Photomultipliers

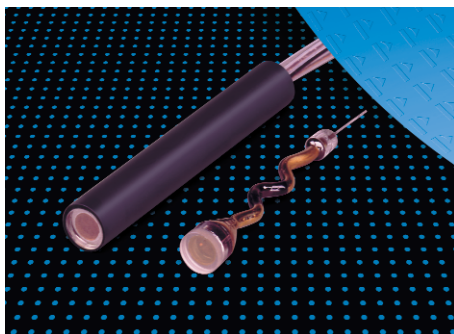

- High Sensitivity Optical Detector
- Extremely High Gain
- Ultra Low Noise
- 1/2 Inch, Head-On Type

### Technical Specifications

Type	Spectral response (nm)	Photocathode material	Min. useful area (mm)	Window material	Electron multiplication	Supply voltage (V)	Current amplification	Equivalent Noise Input, ENI (W)	Bias current (µA)	Max. linear anode current	Max. anode current*	Response time Rise time (ns) Pulse width / FWHM (ns)	Special types for Photon Counting	Supply voltage (V)	Single photo electron gain	Dark counts (cps)	Peak to valley	Max. ambient temperature (°C)
C1311	115-200	CsI	9	MgF <sub>2</sub>	2400 (max. 3000)	5x10 <sup>7</sup>	6x10 <sup>5</sup>	8	2x10 <sup>-17</sup>	50	(DC linearity limit) 10% of bias current	10 µA (max. 30 sec.)	C1311P	3000 (max. 3000)	3x10 <sup>8</sup>	0.4	10:1	50
C1321	115-320	CsTe		MgF <sub>2</sub>			1x10 <sup>6</sup>	40	2x10 <sup>-17</sup>				C1321P			4		
C1322	165-320	CsTe		Quartz			1x10 <sup>6</sup>	40	2x10 <sup>-17</sup>				C1322P			4		
C1342	165-650	Bialkali		Quartz			3x10 <sup>6</sup>	320	2x10 <sup>-17</sup>				C1342P			40		
C1343	185-650			UV glass			3x10 <sup>6</sup>	320	2x10 <sup>-17</sup>				C1343P			40		
C1344	300-650	Borosil.		3x10 <sup>6</sup>			320	2x10 <sup>-17</sup>	C1344P				40					
C1352	165-750	Low noise Multialk.		Quartz			3x10 <sup>6</sup>	1000	4x10 <sup>-17</sup>				C1352P			160		
C1353	185-750			UV glass			3x10 <sup>6</sup>	1000	4x10 <sup>-17</sup>				C1353P			160		
C1362	165-850	Multialk.		Quartz			2x10 <sup>6</sup>	4000	8x10 <sup>-17</sup>				C1362P			400		
C1363	185-850			UV glass			2x10 <sup>6</sup>	4000	8x10 <sup>-17</sup>				C1363P			400		
C1372	165-900	Extend. red Multialk.		Quartz			2x10 <sup>6</sup>	20000	3x10 <sup>-16</sup>				C1372P			2000		
C1373	185-900			UV glass			2x10 <sup>6</sup>	20000	3x10 <sup>-16</sup>				C1373P			2000		
C1382	165-650	Low noise Bialk.		Quartz			3x10 <sup>6</sup>	100	1x10 <sup>-17</sup>				C1382P			10		
C1383	185-650			UV glass			3x10 <sup>6</sup>	100	1x10 <sup>-17</sup>				C1383P			10		

### Dimensions (mm)

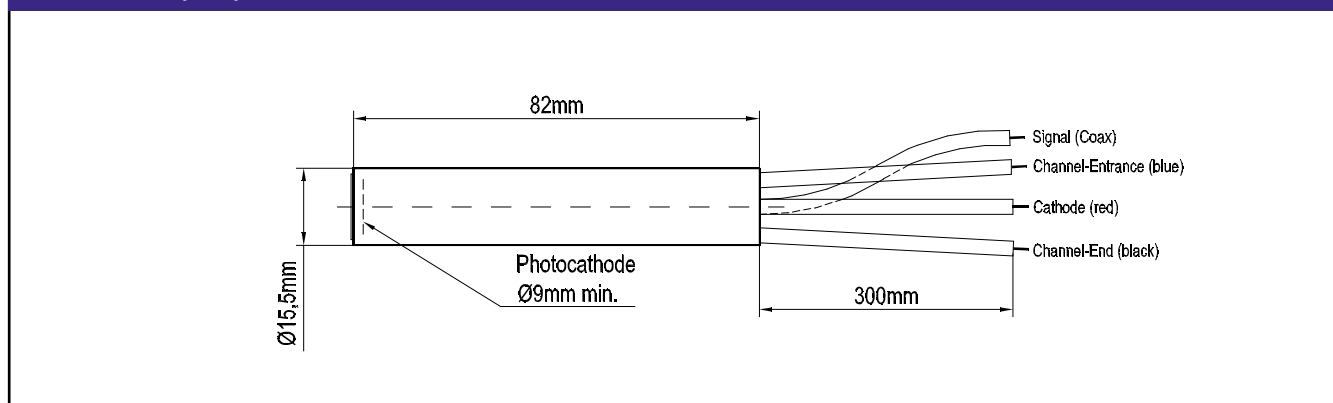



# CPM C1900 Series 3/4" CPM Channel Photomultipliers

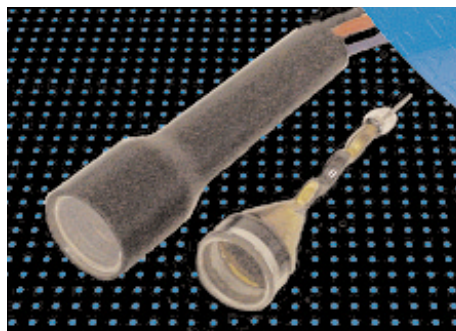

- High Sensitivity Optical Detector
- Extremely High Gain
- Ultra Low Noise
- 3/4 Inch, Head-On Type

## Technical Specifications

Type	Spectral response (nm)	Photocathode material	Min. useful area (mm)	Window material	Electron multiplication	Supply voltage (V)	Current amplification	Dark current (pA)	Equivalent Noise Input, ENI (W)	Bias current (µA)	Max. linear anode current	Max. anode current*	Response time Rise time (ns) Pulse width / FWHM (ns)	Special types for Photon Counting	Supply voltage (V)	Single photo electron gain	Dark counts (cps)	Peak to valley	Max. ambient temperature (°C)
C1911	115-200	CsI	13	MgF <sub>2</sub>	Channel Electron Multiplier	2400 (max. 3000)	6x10 <sup>5</sup>	20	3x10 <sup>-17</sup>	50	(DC linearity limit) 10% of bias current	10 µA (max. 30 sec.)	3 6	C1911P	3000 (max. 3000 )	3x10 <sup>6</sup>	10:1	50	
C1921	115-320	CsTe		MgF <sub>2</sub>			1x10 <sup>6</sup>	100	3x10 <sup>-17</sup>					C1921P					10
C1922	165-320	CsTe		Quartz			1x10 <sup>6</sup>	100	3x10 <sup>-17</sup>					C1922P					10
C1942	165-650	Bialkali		Quartz			3x10 <sup>6</sup>	800	3x10 <sup>-17</sup>					C1942P					100
C1943	185-650			UV glass			3x10 <sup>6</sup>	800	3x10 <sup>-17</sup>					C1943P					100
C1944	300-650	Bialkali		Borosil.			3x10 <sup>6</sup>	800	3x10 <sup>-17</sup>					C1944P					100
C1952	165-750	Low noise Multialk.		Quartz			3x10 <sup>6</sup>	2500	8x10 <sup>-17</sup>					C1952P					400
C1953	185-750			UV glass			3x10 <sup>6</sup>	2500	8x10 <sup>-17</sup>					C1953P					400
C1962	165-850	Multialk.		Quartz			2x10 <sup>6</sup>	10000	1x10 <sup>-16</sup>					C1962P					1000
C1963	185-850			UV glass			2x10 <sup>6</sup>	10000	1x10 <sup>-16</sup>					C1963P					1000
C1972	165-900	Extend. red Multialk.		Quartz			2x10 <sup>6</sup>	50000	5x10 <sup>-16</sup>					C1972P					5000
C1973	185-900			UV glass			2x10 <sup>6</sup>	50000	5x10 <sup>-16</sup>					C1973P					5000
C1982	165-650	Low noise Bialk.		Quartz			3x10 <sup>6</sup>	250	2x10 <sup>-17</sup>					C1982P					25
C1983	185-650		UV glass	3x10 <sup>6</sup>	250	2x10 <sup>-17</sup>	C1983P	25											

## Dimensions (mm)

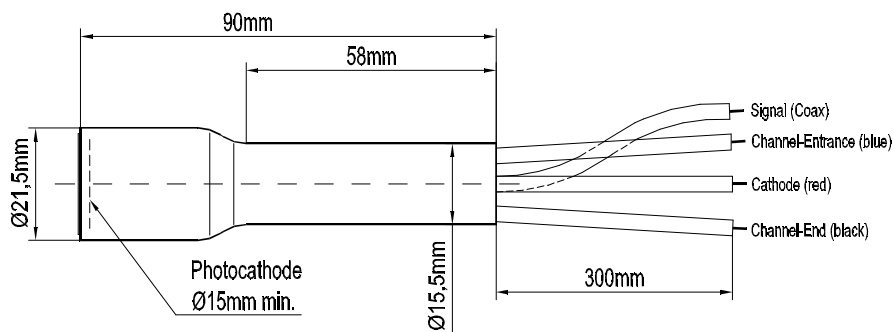

**CPM C1900 Series**  
**3/4" CPM Channel Photomultipliers**

**CPM C1900 Performance Specifications**

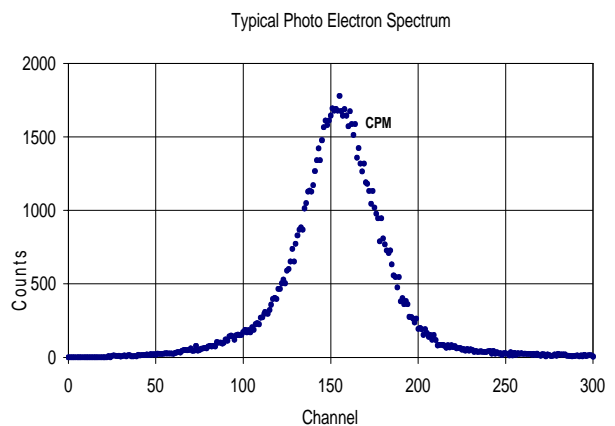
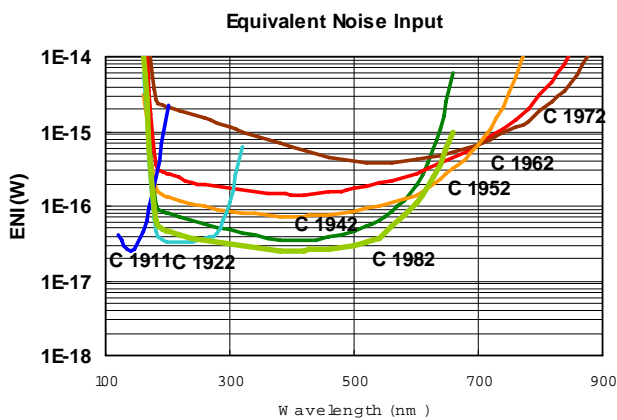
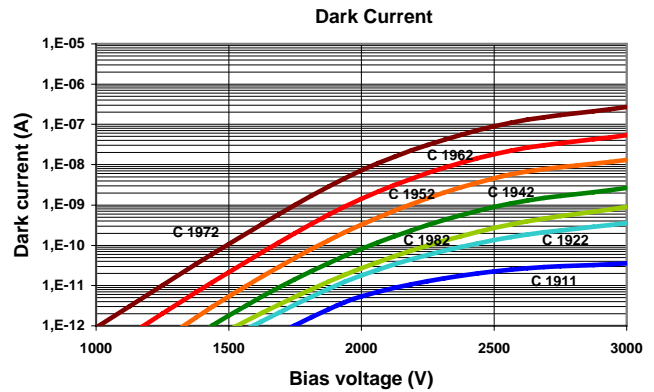
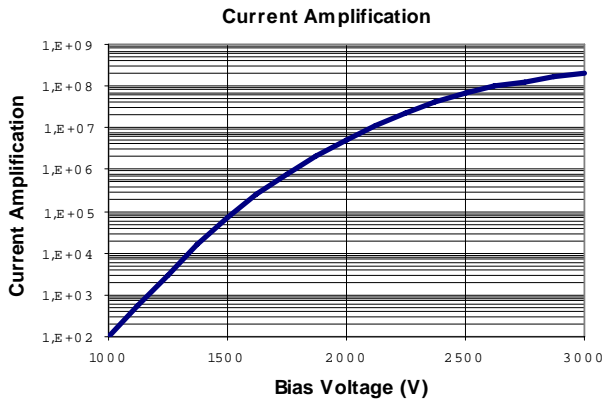
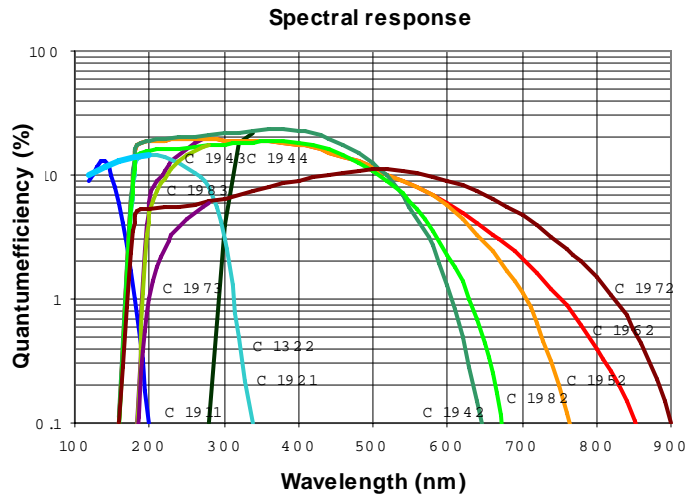

**CAUTION: High Voltage Warning!**

This product is operated at high voltage. Extreme care must be taken to ensure operator safety and to avoid damage to other instruments. Avoid direct contact with the photomultiplier when high voltage is applied. Avoid placing conductive material close to the cathode.  
 All given values are nominal/typical @ 20 °C ambient temperature; specifications subject to change without notice.

**USA:**  
PerkinElmer Optoelectronics  
2175 Mission College Blvd.  
Santa Clara, CA 95054  
Phone: (408) 565-0850  
Fax: (408) 565-0793

**EUROPE:**  
PerkinElmer Optoelectronics GmbH  
Wenzel-Jaksch-Str. 31  
65199 Wiesbaden  
Germany  
Phone: +49 611 492 534  
Fax: +49 611 492 578

**ASIA:**  
PerkinElmer Optoelectronics  
47 Ayer Rajah Crescent #06-12  
Singapore 139947  
Phone: +65 775 2022  
Fax: +65 775 1008





LittleDiode supplies new, hard to find or obsolete electronic components and semiconductors all over the world.

With over two million different components listed you are sure to find the part you need.

Feel free to visit us today at our online store:

[LittleDiode.com](http://LittleDiode.com)

Looking forward to providing you with the best possible service.