

**CA741, CA747, CA748, CA1458, CA1558,
LM741*, LM748*, LM1458*, LM1558***

T-79-05-20

Operational AmplifiersHigh-Gain Single and Dual Operational Amplifiers
For Military, Industrial and Commercial Applications**Features:**

- *Input bias current (all types):*
500 nA max.
- *Input offset current (all types):*
200 nA max.

The RCA-CA1458, CA1558 (dual types); CA741C, CA741 (single-types); CA747C, CA747 (dual types); and CA748C, CA748 (single types) are general-purpose, high-gain operational amplifiers for use in military, industrial, and commercial applications.

These monolithic silicon integrated-circuit devices provide output short-circuit protection and latch-free operation. These types also feature wide common-mode and differential-mode signal ranges and have low-offset voltage nulling capability when used with an appropriately valued potentiometer. A 5-megohm potentiometer is used for offset nulling types CA748C, CA748 (See Fig. 10); a 10-kilohm potentiometer is used for offset nulling types CA741C, CA741, CA747CE, CA747E (See Fig. 9); and types CA1458, CA1558, CA747CT, have no specific terminals for offset nulling. Each type consists of a differential-input amplifier that effectively drives a gain and level-shifting stage having a complementary emitter-follower output.

RCA's manufacturing process make it possible to produce IC operational amplifiers with low-burst ("popcorn") noise characteristics. Type CA6741, a low-noise version of the CA741, gives limit specifications for burst noise in the data

Applications:

- *Comparator*
- *DC amplifier*
- *Integrator or differentiator*
- *Multivibrator*
- *Narrow-band or band-pass filter*
- *Summing amplifier*

bulletin, File No. 530. Contact your RCA Sales Representative for information pertinent to other operational amplifier types that meet low-burst noise specifications.

This operational amplifier line also offers the circuit designer the option of operation with internal or external phase compensation.

Types CA748C and CA748, which are externally phase compensated (terminals 1 and 8) permit a choice of operation for improved bandwidth and slew-rate capabilities. Unity gain with external phase compensation can be obtained with a single 30-pF capacitor. All the other types are internally phase-compensated.

RCA Type No.	No. of Ampl.	Phase Comp.	Offset Voltage Null	Min. AOL	Max. V _{IO} (mV)	Operating-Temperature Range (°C)
CA1458	dual	int.	no	20k	6	0 to +70 ^A
CA1558	dual	int.	no	50k	5	-55 to +125
CA741C	single	int.	yes	20k	6	0 to +70 ^A
CA741	single	int.	yes	50k	5	-55 to +125
CA747C	dual	int.	yes*	20k	6	0 to +70 ^A
CA747	dual	int.	yes*	50k	5	-55 to +125
CA748C	single	ext.	yes	20k	6	0 to +70 ^A
CA748	single	ext.	yes	50k	5	-55 to +125

*In the 14-lead dual-in-line plastic package only.

^AAll types in any package style can be operated over the temperature range of -55 to +125°C, although the published limits for certain electrical specifications apply only over the temperature range of 0 to +70°C.

*Technical Data on LM Branded types is identical to the corresponding CA Branded types.

**CA741, CA747, CA748, CA1458, CA1558,
LM741, LM748, LM1458, LM1558**

T-79-05-20

ORDERING INFORMATION

When ordering any of these types, it is important that the appropriate suffix letter for the package required be affixed to the type number. For example: If a CA1458 in a straight-lead TO-5 style package is desired, order CA1458T.

TYPE NO.	PACKAGE TYPE AND SUFFIX LETTER						FIG. NO.	
	TO-5 STYLE			PLASTIC		CHIP		BEAM-LEAD
	8L	10L	DIL-CAN	8L	14L			
CA1458	T		S	E		H	1d, 1h	
CA1558	T		S	E			1d, 1h	
CA741C	T		S	E		H	1a, 1e	
CA741	T		S	E			L 1a, 1e	
CA747C		T			E	H	1b, 1f	
CA747		T			E		1b, 1f	
CA748C	T		S	E		H	1c, 1g	
CA748	T		S	E			1c, 1g	

MAXIMUM RATINGS, Absolute-Maximum Values at $T_A = 25^\circ\text{C}$:

DC Supply Voltage (between V^+ and V^- terminals):	
CA741C, CA747C [▲] , CA748C, CA1458 [▲]	36 V
CA741, CA747 [▲] , CA748, CA1558 [▲]	44 V
Differential Input Voltage	± 30 V
DC Input Voltage*	± 15 V
Output Short-Circuit Duration	Indefinite
Device Dissipation:	
Up to 70°C (CA741C, CA748C)	500 mW
Up to 75°C (CA741, CA748)	500 mW
Up to 30°C (CA747)	800 mW
Up to 25°C (CA747C)	800 mW
Up to 30°C (CA1558)	680 mW
Up to 25°C (CA1458)	680 mW
For Temperatures Indicated Above	Derate linearly 6.67 mW/ $^\circ\text{C}$
Voltage between Offset Null and V^- (CA741C, CA741, CA747CE)	± 0.5 V
Ambient Temperature Range:	
Operating - CA741, CA747E, CA748, CA1558	-55 to $+125^\circ\text{C}$
CA741C, CA747C, CA748C, CA1458	0 to $+70^\circ\text{C}$ [†]
Storage	-65 to $+150^\circ\text{C}$
Lead Temperature (During Soldering):	
At distance $1/16 \pm 1/32$ inch (1.59 ± 0.79 mm) from case for 10 seconds max.	265°C

* If Supply Voltage is less than ± 15 volts, the Absolute Maximum Input Voltage is equal to the Supply Voltage.

[▲] Voltage values apply for each of the dual operational amplifiers.

[†] All types in any package style can be operated over the temperature range of -55 to $+125^\circ\text{C}$, although the published limits for certain electrical specifications apply only over the temperature range of 0 to $+70^\circ\text{C}$.

**CA741, CA747, CA748, CA1458, CA1558,
LM741, LM748, LM1458, LM1558**

T-79-05-20

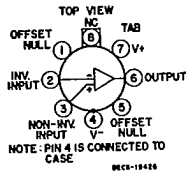

1a.—CA741CS, CA741CT, CA741S, & CA741T with internal phase compensation.

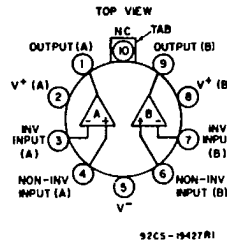

1b.—CA747CT and CA747T with internal phase compensation.

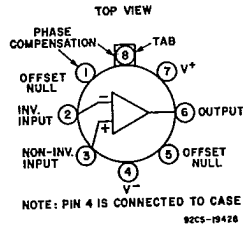

1c.—CA748CS, CA748CT, CA748S, and CA748T with external phase compensation.

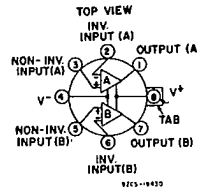

1d.—CA1458S, CA1458T, CA1558S, and CA1558T with internal phase compensation.

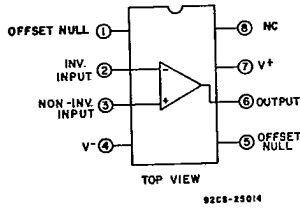

1e.—CA741C and CA741E with internal phase compensation.

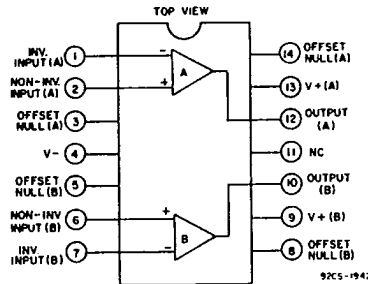

1f.—CA747CE and CA747E with internal phase compensation.

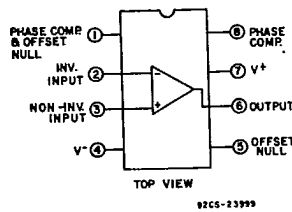

1g.—CA748CE and CA748E with external phase compensation.

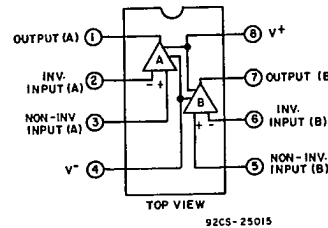

1h.—CA1458E and CA1558E with internal phase compensation.

Fig. 1 — Functional diagrams.

Operational Amplifiers

CA741, CA747, CA748, CA1458, CA1558,
LM741, LM748, LM1458, LM1558

T-79-05-20

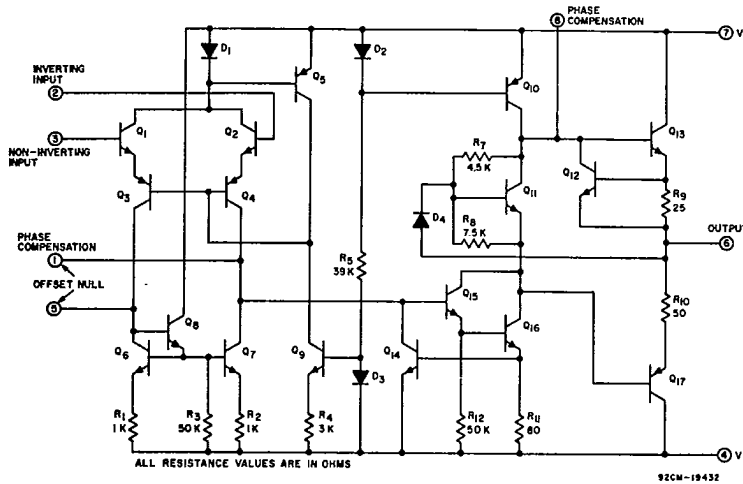

Fig.2—Schematic diagram of operational amplifier with external phase compensation for CA748C and CA748.

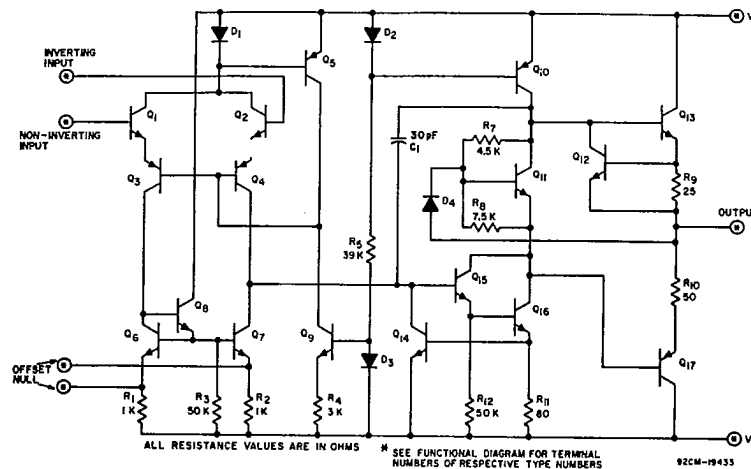

Fig.3—Schematic diagram of operational amplifiers with internal phase compensation for CA741C, CA741, and for each amplifier of the CA747C, CA747, CA1458, and CA1558.

CA741, CA747, CA748, CA1458, CA1558, LM741, LM748, LM1458, LM1558

T-79-05-20

ELECTRICAL CHARACTERISTICS

Typical Values Intended Only for Design Guidance

CHARACTERISTIC	TEST CONDITIONS $V_{\pm} = \pm 15 \text{ V}$	TYP. VALUES ALL TYPES	UNITS
Input Capacitance, C_i		1.4	pF
Offset Voltage Adjustment Range		± 15	mV
Output Resistance, R_O		75	Ω
Output Short-Circuit Current		25	mA
Transient Response: Rise Time, t_r Overshoot	Unity gain $V_i = 20 \text{ mV}$ $R_L = 2 \text{ k}\Omega$ $C_L \leq 100 \text{ pF}$	0.3	μs
		5	%
Slew Rate, SR: Closed-loop Open-loop [▲]	$R_L \geq 2 \text{ k}\Omega$	0.5	V/ μs
		40	

▲ Open-loop slew rate applies only for types CA748C and CA748.

ELECTRICAL CHARACTERISTICS

For Equipment Design

CHARACTERISTIC	TEST CONDITIONS Supply Voltage, $V^+ = 15 \text{ V}$, $V^- = -15 \text{ V}$	Ambient Temperature, T_A	LIMITS			UNITS
			CA741C CA747C* CA748C CA1458*			
			Min.	Typ.	Max.	
Input Offset Voltage, V_{IO}	$R_S \leq 10 \text{ k}\Omega$	25 °C	—	2	6	mV
		0 to 70 °C	—	—	7.5	
Input Offset Current, I_{IO}		25 °C	—	20	200	nA
		0 to 70 °C	—	—	300	
Input Bias Current, I_{IB}		25 °C	—	80	500	nA
		0 to 70 °C	—	—	800	
Input Resistance, R_i			0.3	2	—	M Ω
Open-Loop Differential Voltage Gain, A_{OL}	$R_L \geq 2 \text{ k}\Omega$ $V_O = \pm 10 \text{ V}$	25 °C	20,000	200,000	—	
		0 to 70 °C	15,000	—	—	
Common-Mode Input Voltage Range, V_{ICR}		25 °C	± 12	± 13	—	V
Common-Mode Rejection Ratio, CMRR	$R_S \leq 10 \text{ k}\Omega$	25 °C	70	90	—	dB
Supply-Voltage Rejection Ratio, PSRR	$R_S \leq 10 \text{ k}\Omega$	25 °C	—	30	150	$\mu\text{V/V}$
Output Voltage Swing, V_{OPP}	$R_L \geq 10 \text{ k}\Omega$ $R_L \geq 2 \text{ k}\Omega$	25 °C	± 12	± 14	—	V
		25 °C	± 10	± 13	—	
		0 to 70 °C	± 10	± 13	—	
Supply Current, I^{\pm}		25 °C	—	1.7	2.8	mA
Device Dissipation, P_D		25 °C	—	50	85	mW

* Values apply for each section of the dual amplifiers.

Operational Amplifiers

**CA741, CA747, CA748, CA1458, CA1558,
LM741, LM748, LM1458, LM1558**

T-79-05-20

ELECTRICAL CHARACTERISTICS
For Equipment Design

CHARACTERISTIC	TEST CONDITIONS Supply Voltage, $V^+ = 15\text{ V}$, $V^- = -15\text{ V}$	Ambient Temperature, T_A	LIMITS			UNITS
			CA741 CA747* CA748 CA1558*			
			Min.	Typ.	Max.	
Input Offset Voltage, V_{IO}	$R_S \leq 10\text{ k}\Omega$	25 °C	-	1	5	mV
		-55 to +125 °C	-	1	6	
Input Offset Current, I_{IO}		25 °C	-	20	200	nA
		-55 °C	-	85	500	
		+125 °C	-	7	200	
Input Bias Current, I_{IB}		25 °C	-	80	500	nA
		-55 °C	-	300	1500	
		+125 °C	-	30	500	
Input Resistance, R_I			0.3	2	-	M Ω
Open-Loop Differential Voltage Gain, A_{OL}	$R_L \geq 2\text{ k}\Omega$ $V_O = \pm 10\text{ V}$	25 °C	50,000	200,000	-	
		-55 to +125 °C	25,000	-	-	
Common-Mode Input Voltage Range, V_{ICR}		-55 to +125 °C	± 12	± 13	-	V
Common-Mode Rejection Ratio, CMRR	$R_S \leq 10\text{ k}\Omega$	-55 to +125 °C	70	90	-	dB
Supply Voltage Rejection Ratio, PSRR	$R_S \leq 10\text{ k}\Omega$	-55 to +125 °C	-	30	150	$\mu\text{V/V}$
Output Voltage Swing, V_{OPP}	$R_L \geq 10\text{ k}\Omega$	-55 to +125 °C	± 12	± 14	-	V
	$R_L \geq 2\text{ k}\Omega$	-55 to +125 °C	± 10	± 13	-	
Supply Current, I^{\pm}		25 °C	-	1.7	2.8	mA
		-55 °C	-	2	3.3	
		+125 °C	-	1.5	2.5	
Device Dissipation, P_D		25 °C	-	50	85	mW
		-55 °C	-	60	100	
		+125 °C	-	45	75	

* Values apply for each section of the dual amplifiers.

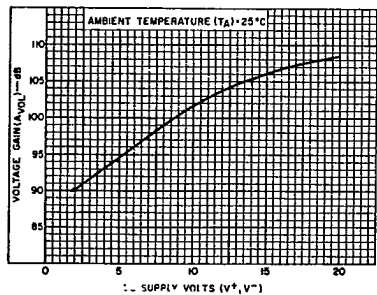

Fig.4—Open-loop voltage gain vs. supply voltage for all types except CA748 and CA748C.

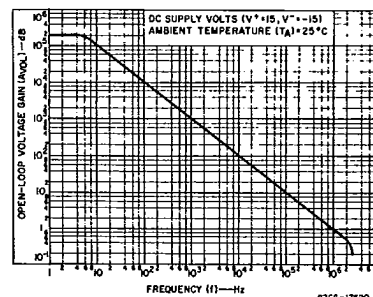

Fig.5—Open-loop voltage gain vs. frequency for all types except CA748 and CA748C.

**CA741, CA747, CA748, CA1458, CA1558,
LM741, LM748, LM1458, LM1558**

T-79-05-20

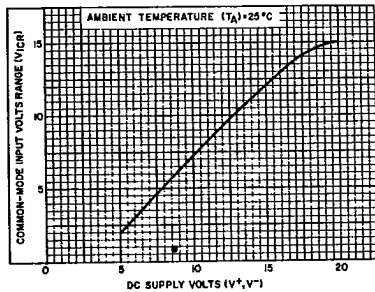

Fig.6—Common-mode input voltage range vs. supply voltage for all types.

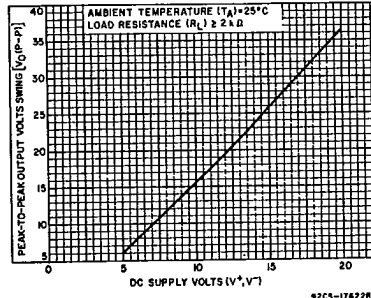

Fig.7—Peak-to-peak output voltage vs. supply voltage for all types except CA748 and CA748C.

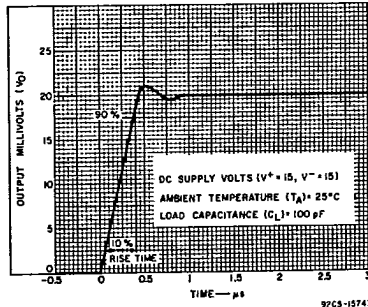

Fig.8—Output voltage vs. transient response time for CA741C and CA741.

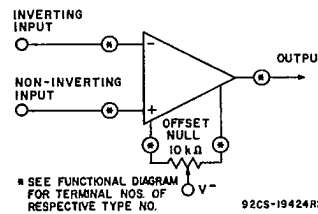

Fig.9—Voltage offset null circuit for CA741C, CA741, CA747GE, and CA747E.

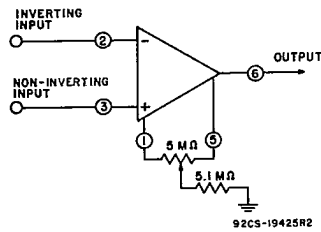

Fig.10—Voltage-offset null circuit for CA748C and CA748.

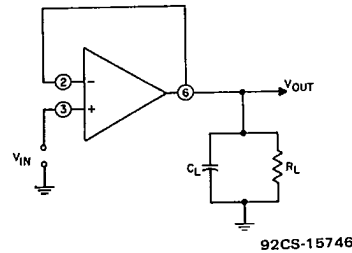

Fig.11—Transient response test circuit for all types.

1-79-05-20

Operational Amplifiers

CA741, CA747, CA748, CA1458, CA1558,
LM741, LM748, LM1458, LM1558

CHIP PHOTOS

Dimensions and Pad Layouts

CA741CH

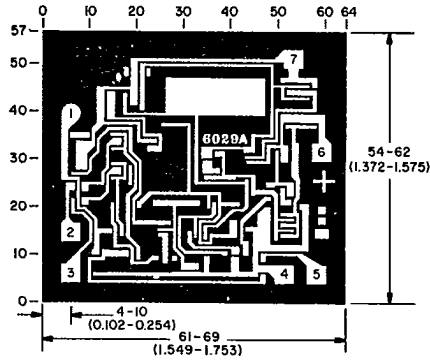

92CS-13259

CA747CH

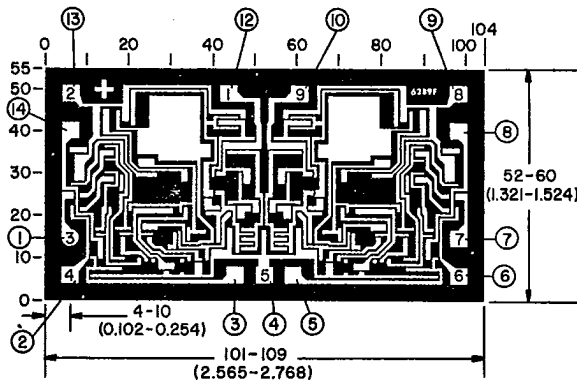

NOTE: NOS. IN PADS ARE FOR 10-LEAD TO-5
NOS. OUTSIDE OF CHIP ARE FOR 14-LEAD DIP

92CM-33260

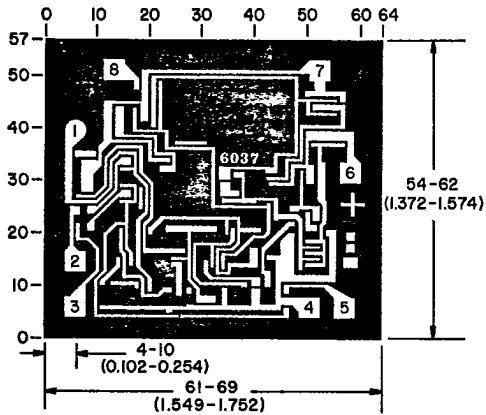

92CS-33261

CA748CH

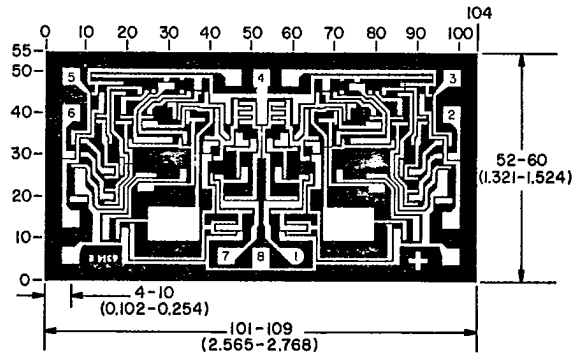

92CS-33263RI

CA1458H

Dimensions in parentheses are in millimeters and are derived from the basic inch dimensions as indicated. Grid graduations are in mils (10^{-3} inch).