

# FDMS6681Z

## P-Channel PowerTrench® MOSFET

-30 V, -49 A, 3.2 mΩ

### Features

- Max  $r_{DS(on)}$  = 3.2 mΩ at  $V_{GS} = -10$  V,  $I_D = -21.1$  A
- Max  $r_{DS(on)}$  = 5.0 mΩ at  $V_{GS} = -4.5$  V,  $I_D = -15.7$  A
- Advanced Package and Silicon combination for low  $r_{DS(on)}$
- HBM ESD protection level of 8kV typical(note 3)
- MSL1 robust package design
- RoHS Compliant

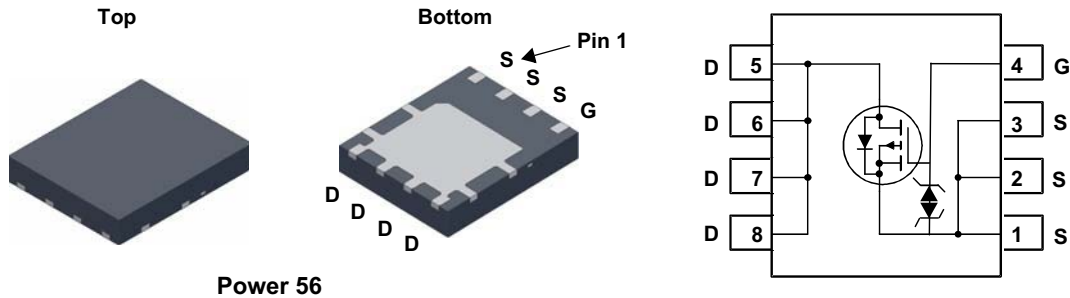


### General Description

The FDMS6681Z has been designed to minimize losses in load switch applications. Advancements in both silicon and package technologies have been combined to offer the lowest  $r_{DS(on)}$  and ESD protection.

### Applications

- Load Switch in Notebook and Server
- Notebook Battery Pack Power Management



### MOSFET Maximum Ratings $T_A = 25$ °C unless otherwise noted

Symbol	Parameter	Rated	Units
$V_{DS}$	Drain to Source Voltage	-30	V
$V_{GS}$	Gate to Source Voltage	±25	V
$I_D$	Drain Current -Continuous (Package limited) $T_C = 25$ °C	-49	A
	-Continuous (Silicon limited) $T_C = 25$ °C	-116	
	-Continuous $T_A = 25$ °C (Note 1a)	-21.1	
	-Pulsed	-90	
$P_D$	Power Dissipation $T_C = 25$ °C	73	W
	Power Dissipation $T_A = 25$ °C (Note 1a)	2.5	
$T_J, T_{STG}$	Operating and Storage Junction Temperature Range	-55 to +150	°C

### Thermal Characteristics

$R_{\theta JC}$	Thermal Resistance, Junction to Case	1.7	°C/W
$R_{\theta JA}$	Thermal Resistance, Junction to Ambient (Note 1a)	50	

### Package Marking and Ordering Information

Device Marking	Device	Package	Reel Size	Tape Width	Quantity
FDMS6681Z	FDMS6681Z	Power 56	13 "	12 mm	3000 units

## Electrical Characteristics $T_J = 25\text{ }^\circ\text{C}$ unless otherwise noted

Symbol	Parameter	Test Conditions	Min	Typ	Max	Units
--------	-----------	-----------------	-----	-----	-----	-------

### Off Characteristics

$BV_{DSS}$	Drain to Source Breakdown Voltage	$I_D = -250\text{ }\mu\text{A}$ , $V_{GS} = 0\text{ V}$	-30			V
$\frac{\Delta BV_{DSS}}{\Delta T_J}$	Breakdown Voltage Temperature Coefficient	$I_D = -250\text{ }\mu\text{A}$ , referenced to $25\text{ }^\circ\text{C}$		20		mV/ $^\circ\text{C}$
$I_{DSS}$	Zero Gate Voltage Drain Current	$V_{DS} = -24\text{ V}$ , $V_{GS} = 0\text{ V}$			-1	$\mu\text{A}$
$I_{GSS}$	Gate to Source Leakage Current	$V_{GS} = \pm 25\text{ V}$ , $V_{DS} = 0\text{ V}$			$\pm 10$	$\mu\text{A}$

### On Characteristics

$V_{GS(th)}$	Gate to Source Threshold Voltage	$V_{GS} = V_{DS}$ , $I_D = -250\text{ }\mu\text{A}$	-1	-1.7	-3	V
$\frac{\Delta V_{GS(th)}}{\Delta T_J}$	Gate to Source Threshold Voltage Temperature Coefficient	$I_D = -250\text{ }\mu\text{A}$ , referenced to $25\text{ }^\circ\text{C}$		-7		mV/ $^\circ\text{C}$
$r_{DS(on)}$	Static Drain to Source On Resistance	$V_{GS} = -10\text{ V}$ , $I_D = -22.1\text{ A}$		2.7	3.2	m $\Omega$
		$V_{GS} = -4.5\text{ V}$ , $I_D = -15.7\text{ A}$		4.0	5.0	
		$V_{GS} = -10\text{ V}$ , $I_D = -22.1\text{ A}$ , $T_J = 125\text{ }^\circ\text{C}$		3.9	5.0	
$g_{FS}$	Forward Transconductance	$V_{DD} = -10\text{ V}$ , $I_D = -22.1\text{ A}$		143		S

### Dynamic Characteristics

$C_{iss}$	Input Capacitance	$V_{DS} = -15\text{ V}$ , $V_{GS} = 0\text{ V}$ , $f = 1\text{ MHz}$		7803	10380	pF
$C_{oss}$	Output Capacitance			1540	2050	pF
$C_{rss}$	Reverse Transfer Capacitance			1345	2020	pF

### Switching Characteristics

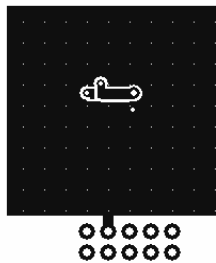
$t_{d(on)}$	Turn-On Delay Time	$V_{DD} = -15\text{ V}$ , $I_D = -22.1\text{ A}$ , $V_{GS} = -10\text{ V}$ , $R_{GEN} = 6\text{ }\Omega$		15	24	ns	
$t_r$	Rise Time			38	61	ns	
$t_{d(off)}$	Turn-Off Delay Time			260	416	ns	
$t_f$	Fall Time			197	316	ns	
$Q_g$	Total Gate Charge		$V_{GS} = 0\text{ V}$ to $-10\text{ V}$		172	241	nC
$Q_g$	Total Gate Charge	$V_{GS} = 0\text{ V}$ to $-5\text{ V}$	$V_{DD} = -15\text{ V}$ , $I_D = -22.1\text{ A}$		97	136	nC
$Q_{gs}$	Gate to Source Charge				22		nC
$Q_{gd}$	Gate to Drain "Miller" Charge				46		nC

### Drain-Source Diode Characteristics

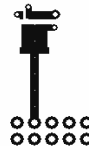
$V_{SD}$	Source to Drain Diode Forward Voltage	$V_{GS} = 0\text{ V}$ , $I_S = -2.1\text{ A}$ (Note 2)		0.68	1.2	V
		$V_{GS} = 0\text{ V}$ , $I_S = -22.1\text{ A}$ (Note 2)		0.79	1.25	V
$t_{rr}$	Reverse Recovery Time	$I_F = -22.1\text{ A}$ , $di/dt = 100\text{ A}/\mu\text{s}$		44	71	ns
$Q_{rr}$	Reverse Recovery Charge			39	63	nC

#### NOTES:

1.  $R_{\theta JA}$  is determined with the device mounted on a 1 in<sup>2</sup> pad 2 oz copper pad on a 1.5 x 1.5 in. board of FR-4 material.  $R_{\theta JC}$  is guaranteed by design while  $R_{\theta CA}$  is determined by the user's board design.



a. 50  $^\circ\text{C}/\text{W}$  when mounted on a 1 in<sup>2</sup> pad of 2 oz copper.

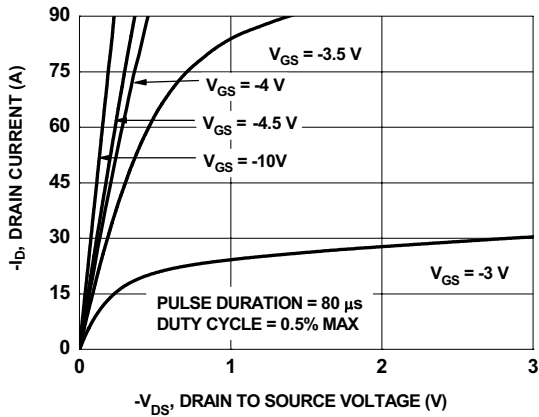


b. 125  $^\circ\text{C}/\text{W}$  when mounted on a minimum pad of 2 oz copper.

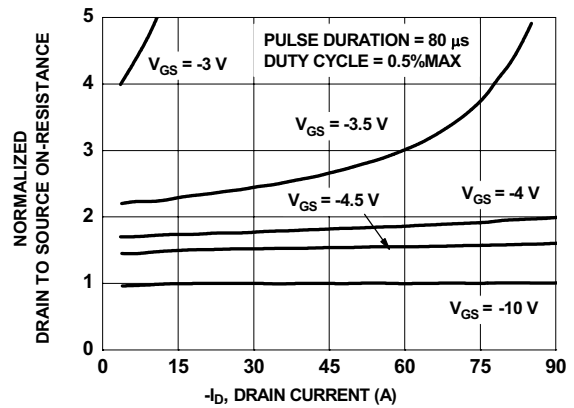
2. Pulse Test: Pulse Width < 300  $\mu\text{s}$ , Duty cycle < 2.0%.

3. The diode connected between the gate and source serves only as protection against ESD. No gate overvoltage rating is implied.

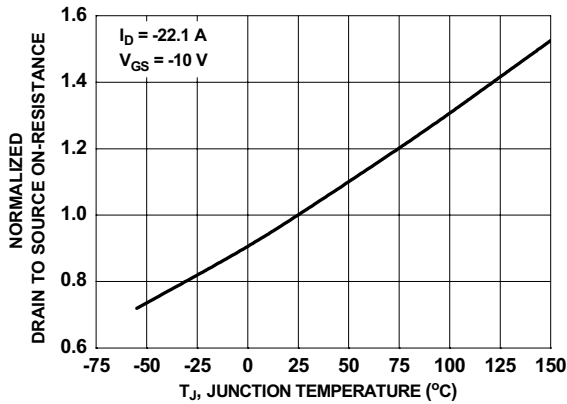
**Typical Characteristics**  $T_J = 25\text{ }^\circ\text{C}$  unless otherwise noted



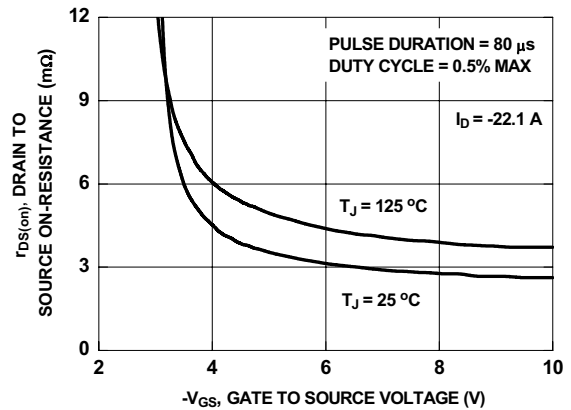
**Figure 1. On Region Characteristics**



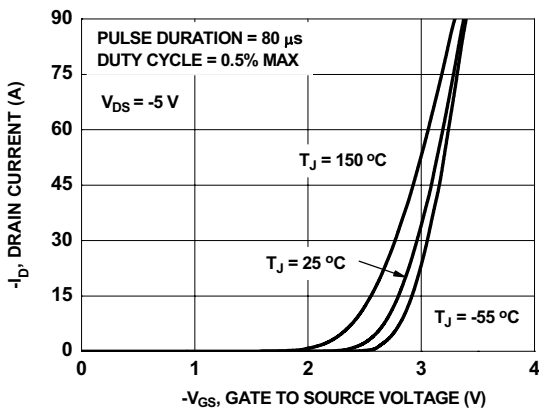
**Figure 2. Normalized On-Resistance vs Drain Current and Gate Voltage**



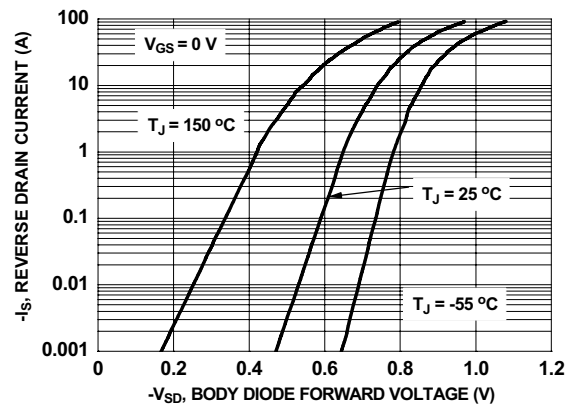
**Figure 3. Normalized On Resistance vs Junction Temperature**



**Figure 4. On-Resistance vs Gate to Source Voltage**

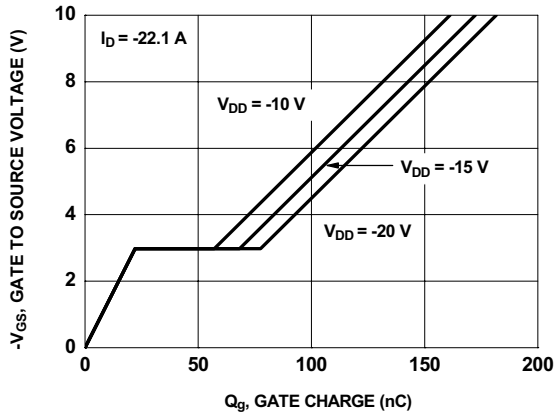


**Figure 5. Transfer Characteristics**

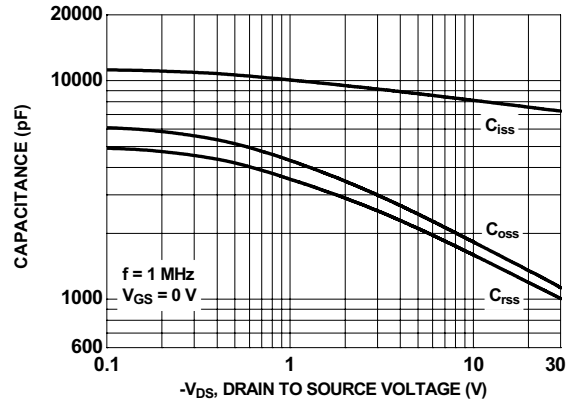


**Figure 6. Source to Drain Diode Forward Voltage vs Source Current**

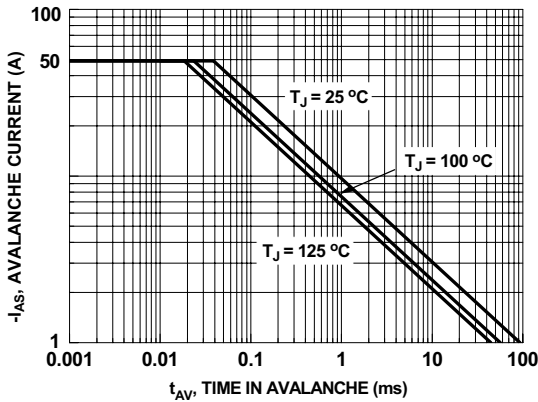
**Typical Characteristics**  $T_J = 25\text{ }^\circ\text{C}$  unless otherwise noted



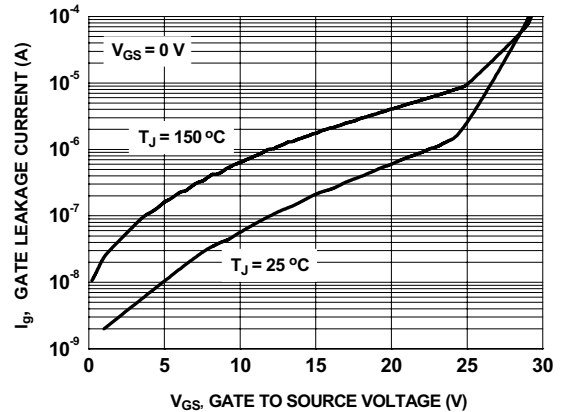
**Figure 7. Gate Charge Characteristics**



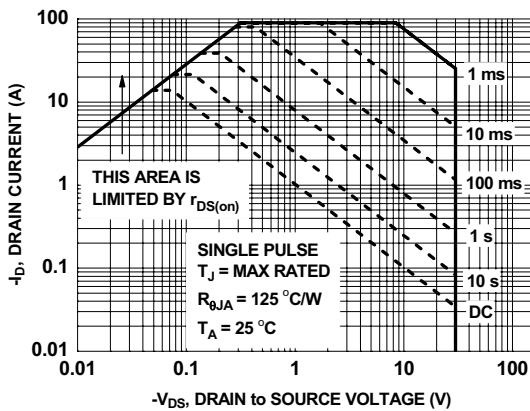
**Figure 8. Capacitance vs Drain to Source Voltage**



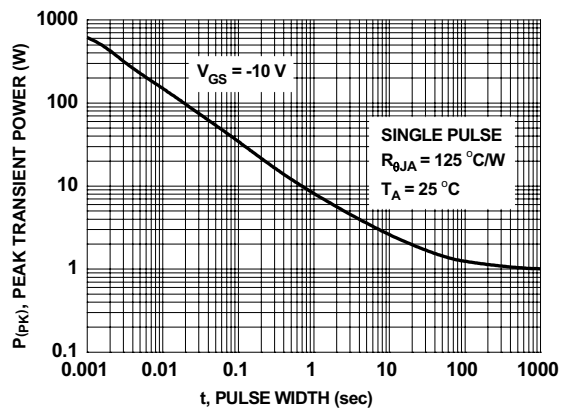
**Figure 9. Unclamped Inductive Switching Capability**



**Figure 10.  $I_{gss}$  vs  $V_{GS}$**

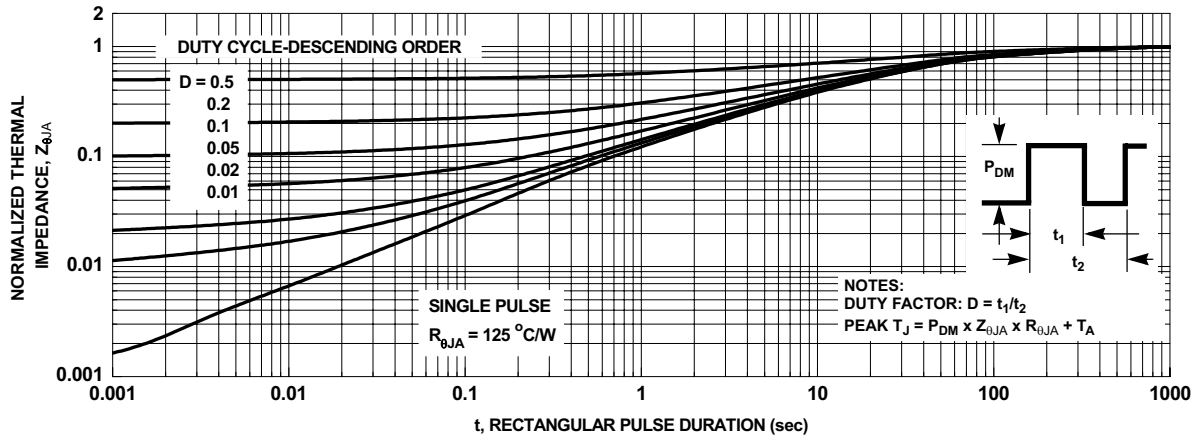


**Figure 11. Forward Bias Safe Operating Area**



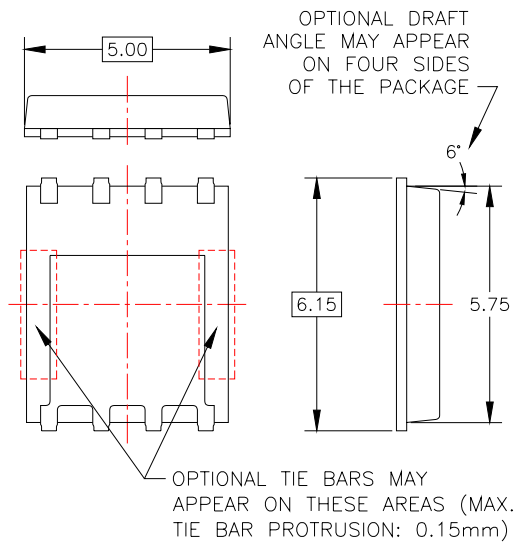
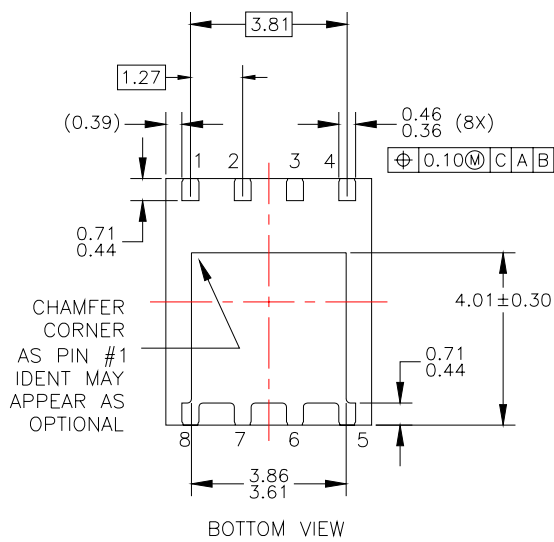
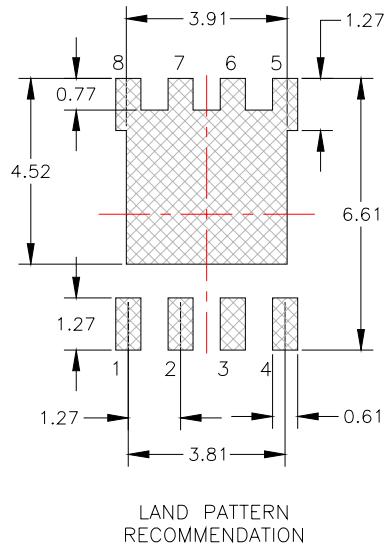
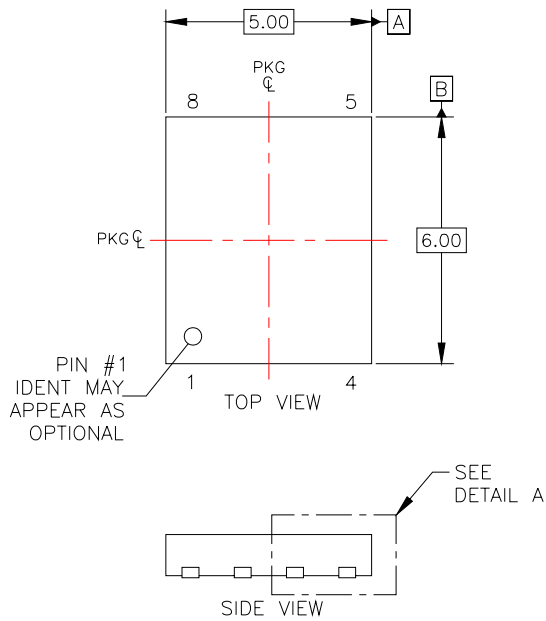
**Figure 12. Single Pulse Maximum Power Dissipation**

**Typical Characteristics**  $T_J = 25\text{ }^\circ\text{C}$  unless otherwise noted



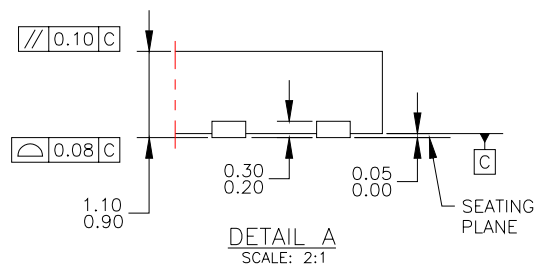
**Figure 13. Junction-to-Ambient Transient Thermal Response Curve**

## Dimensional Outline and Pad Layout



NOTES: UNLESS OTHERWISE SPECIFIED



- A) PACKAGE STANDARD REFERENCE: JEDEC MO-240, ISSUE A, VAR. AA, DATED OCTOBER 2002.
- B) ALL DIMENSIONS ARE IN MILLIMETERS.
- C) DIMENSIONS DO NOT INCLUDE BURRS OR MOLD FLASH. MOLD FLASH OR BURRS DOES NOT EXCEED 0.10MM.
- D) DIMENSIONING AND TOLERANCING PER ASME Y14.5M-1994.
- E) DRAWING FILE NAME: PQFN08AREV4







**TRADEMARKS**

The following includes registered and unregistered trademarks and service marks, owned by Fairchild Semiconductor and/or its global subsidiaries, and is not intended to be an exhaustive list of all such trademarks.

Auto-SPM™  
 Build it Now™  
 CorePLUS™  
 CorePOWER™  
 CROSSVOLT™  
 CTL™  
 Current Transfer Logic™  
 EcoSPARK®  
 EfficientMax™  
 EZSWITCH™ \*  
  
  
 Fairchild®  
 Fairchild Semiconductor®  
 FACT Quiet Series™  
 FACT®  
 FAST®  
 FastvCore™  
 FETBench™  
 FlashWriter® \*  
 FPS™

F-PFS™  
 FRFET®  
 Global Power ResourceSM  
 Green FPS™  
 Green FPS™ e-Series™  
 Gmax™  
 GTO™  
 IntelliMAX™  
 ISOPLANAR™  
 MegaBuck™  
 MICROCOUPLER™  
 MicroFET™  
 MicroPak™  
 MillerDrive™  
 MotionMax™  
 Motion-SPM™  
 OPTOLOGIC®  
 OPTOPLANAR®  
  
 PDP SPM™  
 Power-SPM™

PowerTrench®  
 PowerXS™  
 Programmable Active Droop™  
 QFET®  
 QS™  
 Quiet Series™  
 RapidConfigure™  
  
 Saving our world, 1mW /W /kW at a time™  
 SmartMax™  
 SMART START™  
 SPM®  
 STEALTH™  
 SuperFET™  
 SuperSOT™-3  
 SuperSOT™-6  
 SuperSOT™-8  
 SupreMOS™  
 SyncFET™  
 Sync-Lock™  


The Power Franchise®  
 the power®  
 franchise  
 TinyBoost™  
 TinyBuck™  
 TinyLogic®  
 TINYOPTO™  
 TinyPower™  
 TinyPWM™  
 TinyWire™  
 TriFault Detect™  
 TRUECURRENT™ \*  
 μSerDes™  
  
 UHC®  
 Ultra FRFET™  
 UniFET™  
 VCX™  
 VisualMax™  
 XS™

\*Trademarks of System General Corporation, used under license by Fairchild Semiconductor.

**DISCLAIMER**

FAIRCHILD SEMICONDUCTOR RESERVES THE RIGHT TO MAKE CHANGES WITHOUT FURTHER NOTICE TO ANY PRODUCTS HEREIN TO IMPROVE RELIABILITY, FUNCTION, OR DESIGN. FAIRCHILD DOES NOT ASSUME ANY LIABILITY ARISING OUT OF THE APPLICATION OR USE OF ANY PRODUCT OR CIRCUIT DESCRIBED HEREIN; NEITHER DOES IT CONVEY ANY LICENSE UNDER ITS PATENT RIGHTS, NOR THE RIGHTS OF OTHERS. THESE SPECIFICATIONS DO NOT EXPAND THE TERMS OF FAIRCHILD'S WORLDWIDE TERMS AND CONDITIONS, SPECIFICALLY THE WARRANTY THEREIN, WHICH COVERS THESE PRODUCTS.

**LIFE SUPPORT POLICY**

FAIRCHILD'S PRODUCTS ARE NOT AUTHORIZED FOR USE AS CRITICAL COMPONENTS IN LIFE SUPPORT DEVICES OR SYSTEMS WITHOUT THE EXPRESS WRITTEN APPROVAL OF FAIRCHILD SEMICONDUCTOR CORPORATION.

As used herein:

1. Life support devices or systems are devices or systems which, (a) are intended for surgical implant into the body or (b) support or sustain life, and (c) whose failure to perform when properly used in accordance with instructions for use provided in the labeling, can be reasonably expected to result in a significant injury of the user.
2. A critical component in any component of a life support, device, or system whose failure to perform can be reasonably expected to cause the failure of the life support device or system, or to affect its safety or effectiveness.

**ANTI-COUNTERFEITING POLICY**

Fairchild Semiconductor Corporation's Anti-Counterfeiting Policy. Fairchild's Anti-Counterfeiting Policy is also stated on our external website, www.Fairchildsemi.com, under Sales Support.

Counterfeiting of semiconductor parts is a growing problem in the industry. All manufactures of semiconductor products are experiencing counterfeiting of their parts. Customers who inadvertently purchase counterfeit parts experience many problems such as loss of brand reputation, substandard performance, failed application, and increased cost of production and manufacturing delays. Fairchild is taking strong measures to protect ourselves and our customers from the proliferation of counterfeit parts. Fairchild strongly encourages customers to purchase Fairchild parts either directly from Fairchild or from Authorized Fairchild Distributors who are listed by country on our web page cited above. Products customers buy either from Fairchild directly or from Authorized Fairchild Distributors are genuine parts, have full traceability, meet Fairchild's quality standards for handling and storage and provide access to Fairchild's full range of up-to-date technical and product information. Fairchild and our Authorized Distributors will stand behind all warranties and will appropriately address and warranty issues that may arise. Fairchild will not provide any warranty coverage or other assistance for parts bought from Unauthorized Sources. Fairchild is committed to combat this global problem and encourage our customers to do their part in stopping this practice by buying direct or from authorized distributors.

**PRODUCT STATUS DEFINITIONS**

**Definition of Terms**

Datasheet Identification	Product Status	Definition
Advance Information	Formative / In Design	Datasheet contains the design specifications for product development. Specifications may change in any manner without notice.
Preliminary	First Production	Datasheet contains preliminary data; supplementary data will be published at a later date. Fairchild Semiconductor reserves the right to make changes at any time without notice to improve design.
No Identification Needed	Full Production	Datasheet contains final specifications. Fairchild Semiconductor reserves the right to make changes at any time without notice to improve the design.
Obsolete	Not In Production	Datasheet contains specifications on a product that is discontinued by Fairchild Semiconductor. The datasheet is for reference information only.

Rev. 140



LittleDiode supplies new, hard to find or obsolete electronic components and semiconductors all over the world.

With over two million different components listed you are sure to find the part you need.

Feel free to visit us today at our online store:

[LittleDiode.com](http://LittleDiode.com)

Looking forward to providing you with the best possible service.