

# International IOR Rectifier

## 18TQ... 18TQ...S

SCHOTTKY RECTIFIER

18 Amp

$I_{F(AV)} = 18\text{Amp}$   
 $V_R = 35 \text{ to } 45\text{V}$

### Major Ratings and Characteristics

Characteristics	18TQ	Units
$I_{F(AV)}$ Rectangular waveform	18	A
$V_{RRM}$ range	35 to 45	V
$I_{FSM}$ @tp = 5 $\mu$ s sine	1800	A
$V_F$ @18 Apk, $T_J = 125^\circ\text{C}$	0.53	V
$T_J$ range	-55 to 175	$^\circ\text{C}$

### Description/Features

The 18TQ Schottky rectifier series has been optimized for low reverse leakage at high temperature. The proprietary barrier technology allows for reliable operation up to 175 $^\circ\text{C}$  junction temperature. Typical applications are in switching power supplies, converters, free-wheeling diodes, and reverse battery protection.

- 175 $^\circ\text{C}$   $T_J$  operation
- High purity, high temperature epoxy encapsulation for enhanced mechanical strength and moisture resistance
- Low forward voltage drop
- High frequency operation
- Guard ring for enhanced ruggedness and long term reliability

### Case Styles

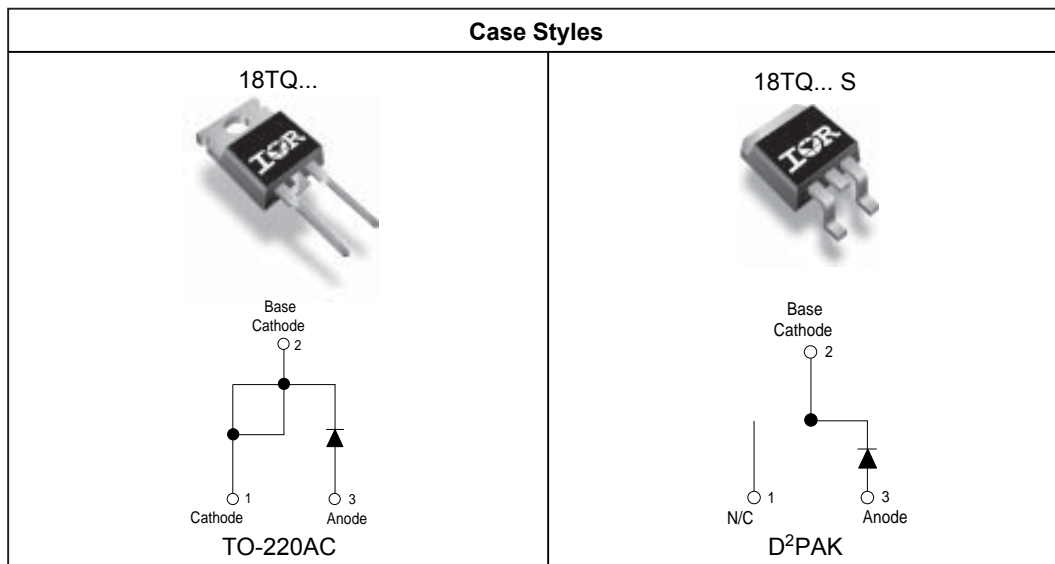

## Voltage Ratings

Part number	18TQ035	18TQ040	18TQ045
$V_R$ Max. DC Reverse Voltage (V)	35	40	45
$V_{RWM}$ Max. Working Peak Reverse Voltage (V)			

## Absolute Maximum Ratings

Parameters	18TQ	Units	Conditions
$I_{F(AV)}$ Max. Average Forward Current * See Fig. 5	18	A	50% duty cycle @ $T_C = 149^\circ\text{C}$ , rectangular wave form
$I_{FSM}$ Max. Peak One Cycle Non-Repetitive Surge Current * See Fig. 7	1800	A	Following any rated load condition and with rated $V_{RWM}$ applied
	390		
$E_{AS}$ Non-Repetitive Avalanche Energy	24	mJ	$T_J = 25^\circ\text{C}$ , $I_{AS} = 3.6\text{Amps}$ , $L = 3.7\text{mH}$
$I_{AR}$ Repetitive Avalanche Current	3.6	A	Current decaying linearly to zero in 1 $\mu\text{sec}$ Frequency limited by $T_J$ max. $V_A = 1.5 \times V_R$ typical

## Electrical Specifications

Parameters	18TQ	Units	Conditions
$V_{FM}$ Max. Forward Voltage Drop (1) * See Fig. 1	0.60	V	@ 18A
	0.72	V	@ 36A
	0.53	V	@ 18A
	0.67	V	@ 36A
$I_{RM}$ Max. Reverse Leakage Current (1) * See Fig. 2	2.5	mA	$T_J = 25^\circ\text{C}$
	25	mA	$T_J = 125^\circ\text{C}$
$C_T$ Max. Junction Capacitance	1400	pF	$V_R = 5V_{DC}$ , (test signal range 100Khz to 1Mhz) $25^\circ\text{C}$
$L_S$ Typical Series Inductance	8.0	nH	Measured lead to lead 5mm from package body
$dv/dt$ Max. Voltage Rate of Change (Rated $V_R$ )	10000	V/ $\mu\text{s}$	

(1) Pulse Width < 300 $\mu\text{s}$ , Duty Cycle < 2%

## Thermal-Mechanical Specifications

Parameters	18TQ	Units	Conditions
$T_J$ Max. Junction Temperature Range	-55 to 175	$^\circ\text{C}$	
$T_{stg}$ Max. Storage Temperature Range	-55 to 175	$^\circ\text{C}$	
$R_{thJC}$ Max. Thermal Resistance Junction to Case	1.50	$^\circ\text{C/W}$	DC operation * See Fig. 4
$R_{thCS}$ Typical Thermal Resistance, Case to Heatsink	0.50	$^\circ\text{C/W}$	Mounting surface, smooth and greased
wt Approximate Weight	2 (0.07)		g (oz.)
T Mounting Torque	Min.	6 (5)	Kg-cm (lbf-in)
	Max.	12 (10)	

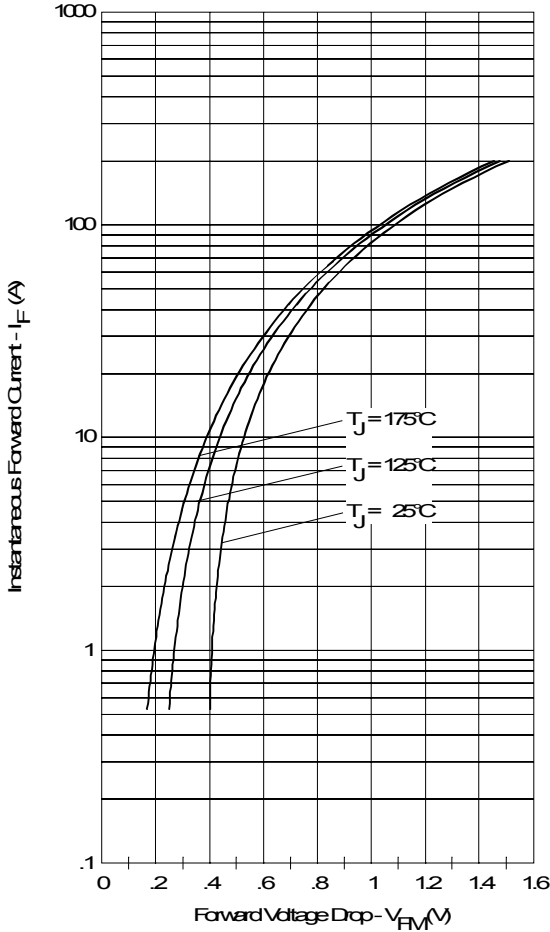

Fig. 1 - Maximum Forward Voltage Drop Characteristics

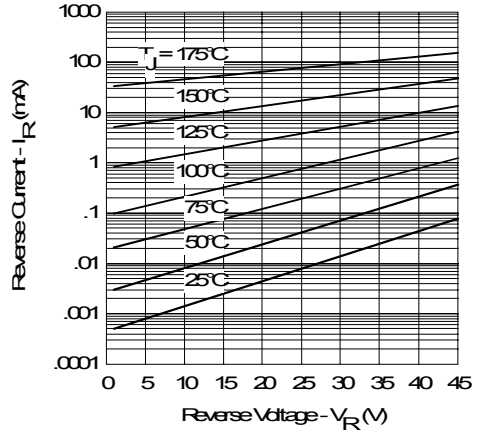

Fig. 2 - Typical Values of Reverse Current Vs. Reverse Voltage

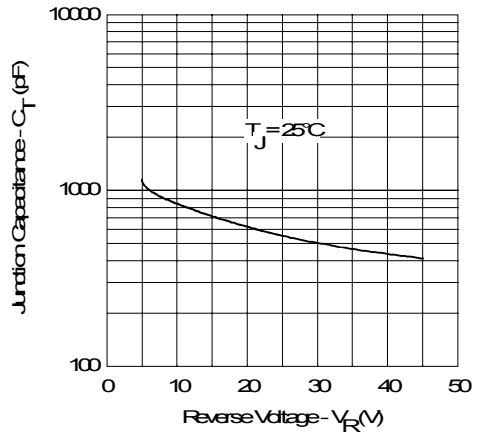

Fig. 3 - Typical Junction Capacitance Vs. Reverse Voltage

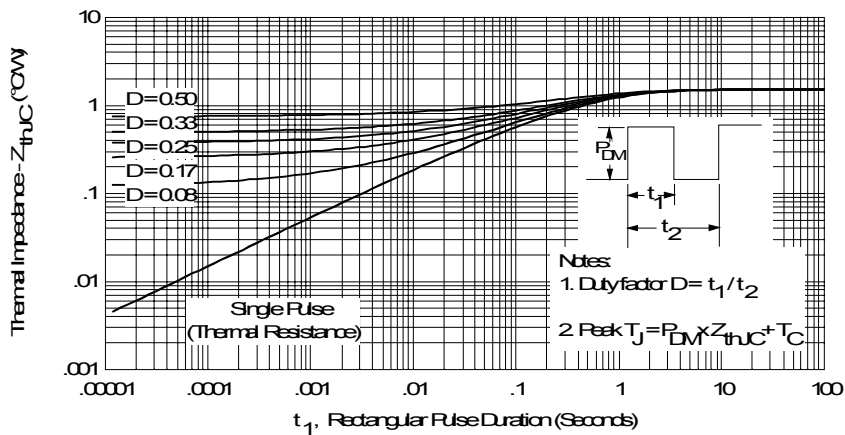

Fig. 4 - Maximum Thermal Impedance  $Z_{thJC}$  Characteristics

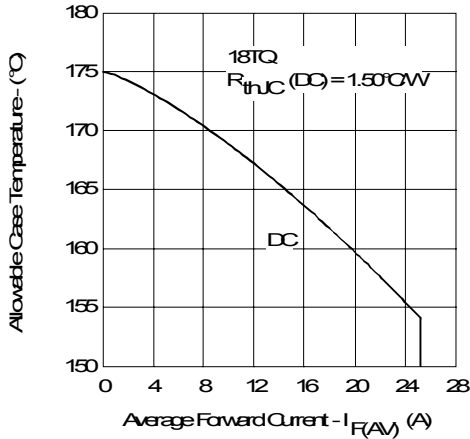

Fig. 5 - Maximum Allowable Case Temperature Vs. Average Forward Current

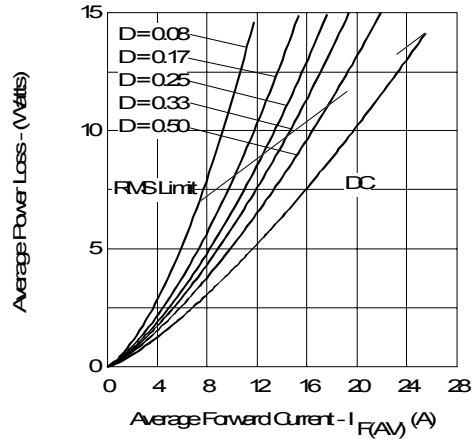

Fig. 6 - Forward Power Loss Characteristics

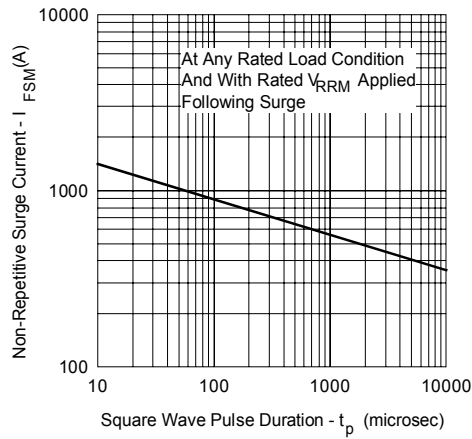

Fig. 7 - Maximum Non-Repetitive Surge Current

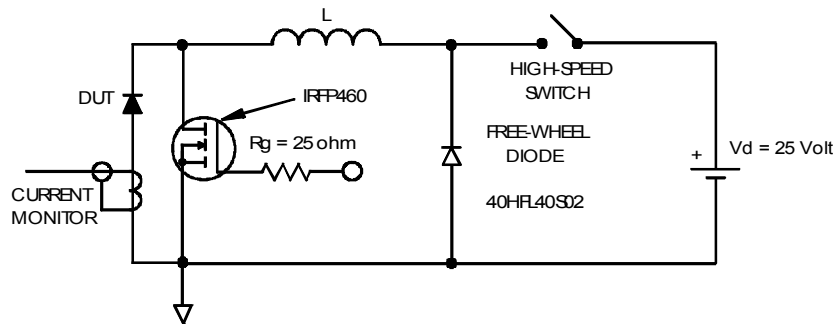
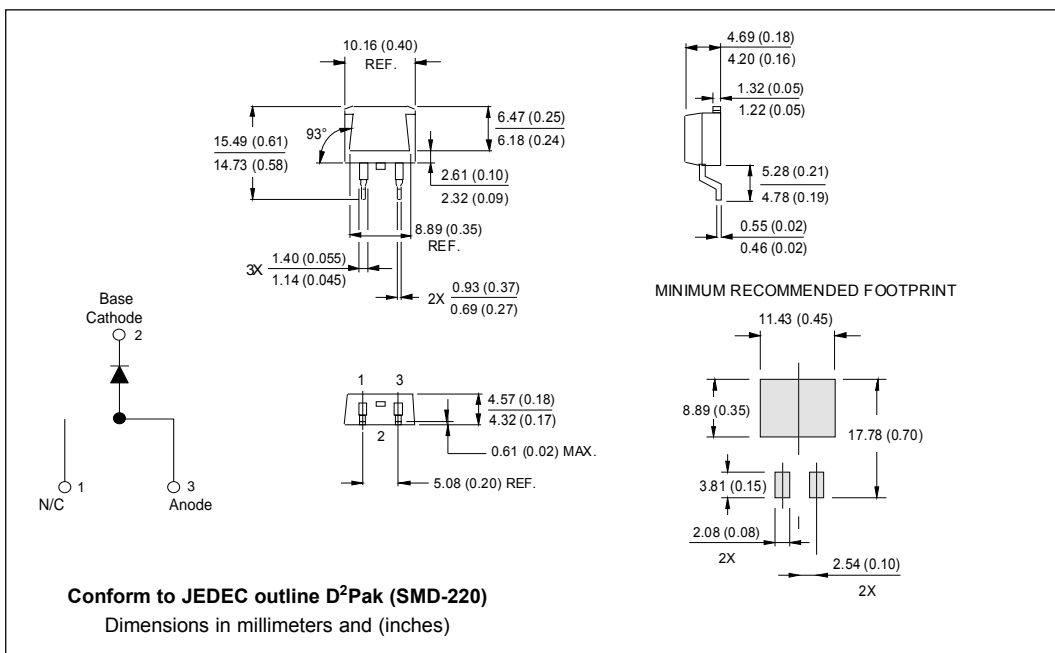
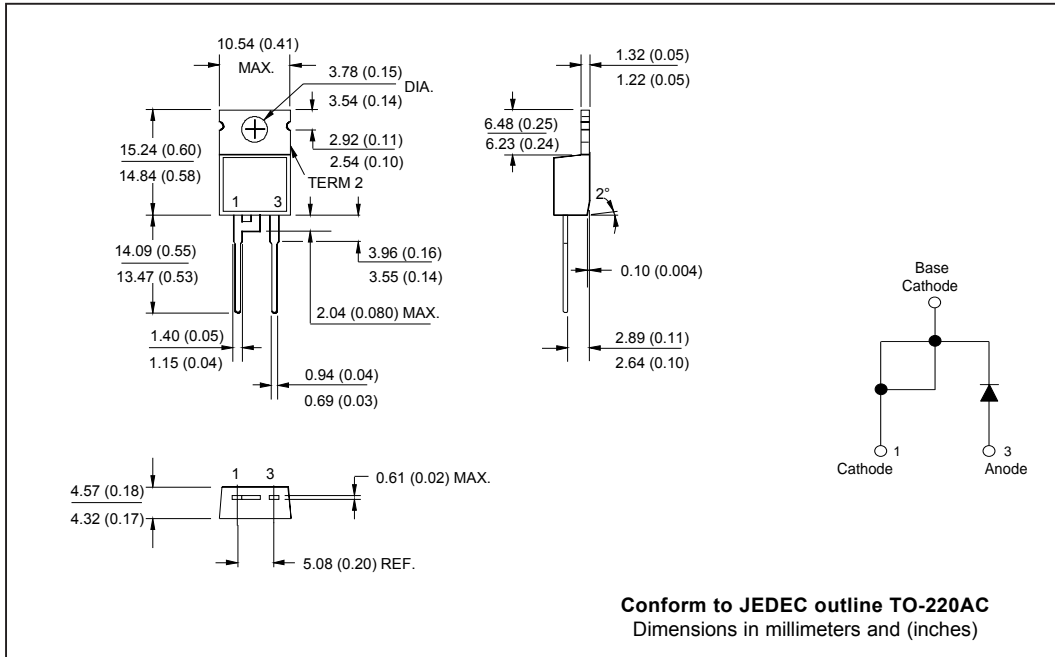
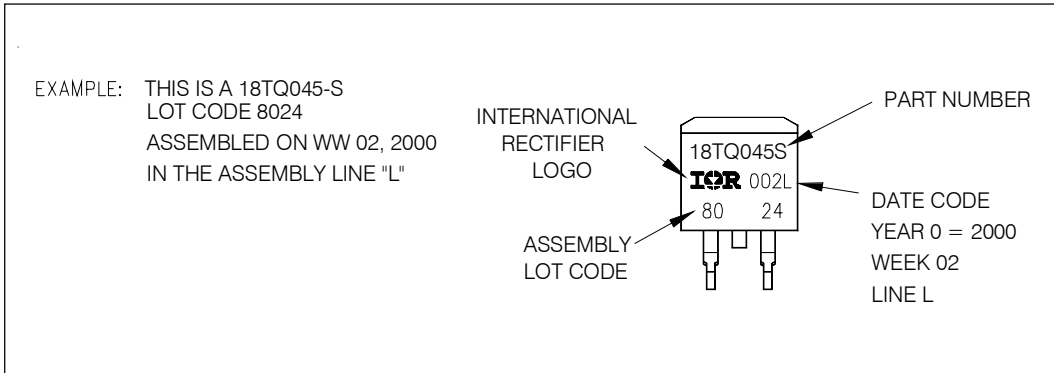

Fig. 8 - Unclamped Inductive Test Circuit

Outline Table



Marking Information



Tape & Reel Information

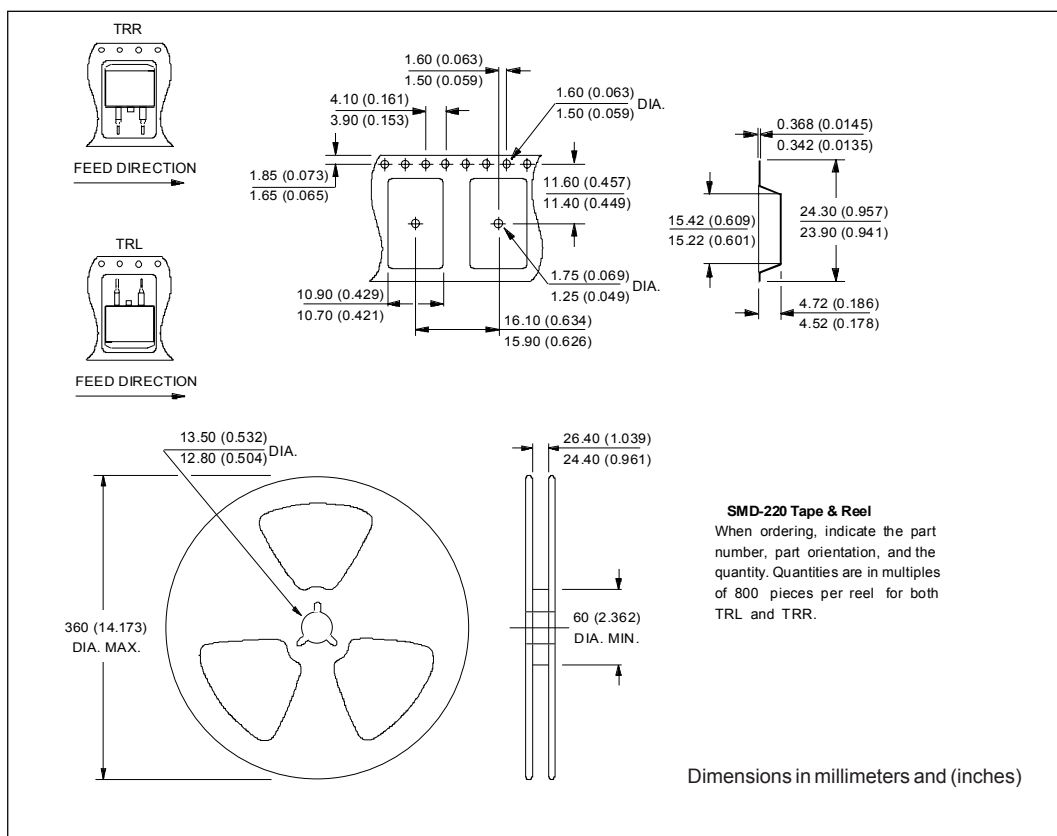

Ordering Information Table

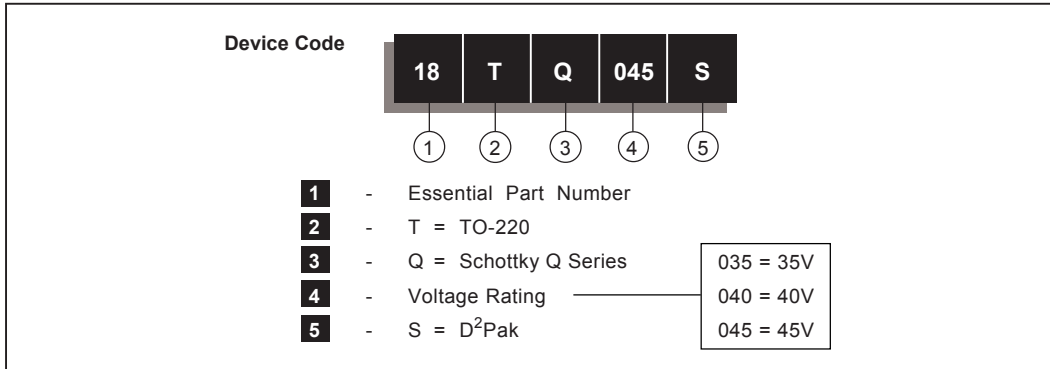

```

18TQ045
*****
* This model has been developed by *
* Wizard SPICE MODEL GENERATOR (1999) *
* (International Rectifier Corporation) *
* Contains Proprietary Information *
*****
* SPICE Model Diode is composed by a *
* simple diode plus paralld VCG2T *
*****
.SUBCKT 18TQ045 ANO CAT
D1 ANO 1 DMOD (0.10899)
*Define diode model
.MODEL DMOD D(IS=4.49213078685186E-05A,N=1.23149728754907,BV=52V,
+ IBV=9.03115410463162E-02A,RS= 0.000664839,CJO=2.73074429693125E-08,
+ VJ=0.881972575936711,XTI=2, EG=0.789061316955255)
*****
*Implementation of VCG2T
VX 1 2 DC 0V
R1 2 CAT TRES 1E-6
.MODEL TRES RES(R=1,TC1=18.1199792035774)
GP1 ANO CAT VALUE={-ABS(I(VX))*(EXP(((((-3.316412E-03/18.11998)*((V(2,CAT)*1E6)/(I(VX)+1E-6)-
1))+1)*6.806625E-02*ABS(V(ANO,CAT))))-1)}
*****
.ENDS 18TQ045

Thermal Model Subcircuit
.SUBCKT 18TQ045 5 1

CTHERM1 5 4 6.49E-01
CTHERM2 4 3 3.46E+00
CTHERM3 3 2 1.63E+01
CTHERM4 2 1 3.01E+02

RTHERM1 5 4 6.77E-01
RTHERM2 4 3 5.70E-01
RTHERM1 3 2 2.05E-01
RTHERM1 2 1 3.44E-02

.ENDS 18TQ045
    
```

18TQ... Series

Bulletin PD-20178 rev. C 07/03

International  
**IOR** Rectifier

---

Data and specifications subject to change without notice.  
This product has been designed and qualified for Industrial Level.  
Qualification Standards can be found on IR's Web site.

International  
**IOR** Rectifier

**IR WORLD HEADQUARTERS:** 233 Kansas St., El Segundo, California 90245, USA Tel: (310) 252-7105  
TAC Fax: (310) 252-7309  
Visit us at [www.irf.com](http://www.irf.com) for sales contact information. 07/03



LittleDiode supplies new, hard to find or obsolete electronic components and semiconductors all over the world.

With over two million different components listed you are sure to find the part you need.

Feel free to visit us today at our online store:

[LittleDiode.com](http://LittleDiode.com)

Looking forward to providing you with the best possible service.