

IRF1010NS

IRF1010NL

HEXFET® Power MOSFET

- Advanced Process Technology
- Ultra Low On-Resistance
- Dynamic dv/dt Rating
- 175°C Operating Temperature
- Fast Switching
- Fully Avalanche Rated

Description

Advanced HEXFET® Power MOSFETs from International Rectifier utilize advanced processing techniques to achieve extremely low on-resistance per silicon area. This benefit, combined with the fast switching speed and ruggedized device design that HEXFET power MOSFETs are well known for, provides the designer with an extremely efficient and reliable device for use in a wide variety of applications.

The D²Pak is a surface mount power package capable of accommodating die sizes up to HEX-4. It provides the highest power capability and the lowest possible on-resistance in any existing surface mount package. The D²Pak is suitable for high current applications because of its low internal connection resistance and can dissipate up to 2.0W in a typical surface mount application.

The through-hole version (IRF1010NL) is available for low-profile applications.

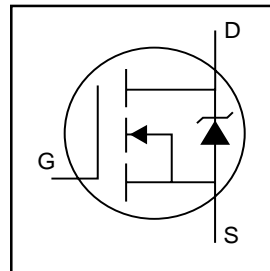

$V_{DSS} = 55V$
$R_{DS(on)} = 11m\Omega$
$I_D = 85A \text{⑦}$

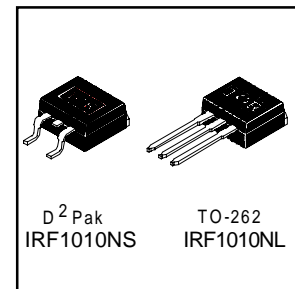

Absolute Maximum Ratings

	Parameter	Max.	Units
$I_D @ T_C = 25^\circ C$	Continuous Drain Current, $V_{GS} @ 10V \text{⑧}$	85⑦	A
$I_D @ T_C = 100^\circ C$	Continuous Drain Current, $V_{GS} @ 10V \text{⑧}$	60	
I_{DM}	Pulsed Drain Current ①⑧	290	
$P_D @ T_C = 25^\circ C$	Power Dissipation	180	W
	Linear Derating Factor	1.2	W/°C
V_{GS}	Gate-to-Source Voltage	± 20	V
I_{AR}	Avalanche Current①	43	A
E_{AR}	Repetitive Avalanche Energy①	18	mJ
dv/dt	Peak Diode Recovery dv/dt ③⑧	3.6	V/ns
T_J	Operating Junction and Storage Temperature Range	-55 to + 175	°C
T_{STG}			
	Mounting torque, 6-32 or M3 screw	10 lbf•in (1.1N•m)	

Thermal Resistance

	Parameter	Typ.	Max.	Units
$R_{\theta JC}$	Junction-to-Case	—	0.85	°C/W
$R_{\theta JA}$	Junction-to-Ambient (PCB Mounted, steady-state)**	—	40	

IRF1010NS/IRF1010NL

International
IR Rectifier

Electrical Characteristics @ T_J = 25°C (unless otherwise specified)

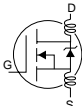
	Parameter	Min.	Typ.	Max.	Units	Conditions
V _{(BR)DSS}	Drain-to-Source Breakdown Voltage	55	—	—	V	V _{GS} = 0V, I _D = 250μA
ΔV _{(BR)DSS} /ΔT _J	Breakdown Voltage Temp. Coefficient	—	0.058	—	V/°C	Reference to 25°C, I _D = 1mA ⑧
R _{DS(on)}	Static Drain-to-Source On-Resistance	—	—	11	mΩ	V _{GS} = 10V, I _D = 43A ④
V _{GS(th)}	Gate Threshold Voltage	2.0	—	4.0	V	V _{DS} = V _{GS} , I _D = 250μA
g _{fs}	Forward Transconductance	32	—	—	S	V _{DS} = 25V, I _D = 43A④⑧
I _{DSS}	Drain-to-Source Leakage Current	—	—	25	μA	V _{DS} = 55V, V _{GS} = 0V
		—	—	250		V _{DS} = 44V, V _{GS} = 0V, T _J = 150°C
I _{GSS}	Gate-to-Source Forward Leakage	—	—	100	nA	V _{GS} = 20V
	Gate-to-Source Reverse Leakage	—	—	-100		V _{GS} = -20V
Q _g	Total Gate Charge	—	—	120	nC	I _D = 43A
Q _{gs}	Gate-to-Source Charge	—	—	19		V _{DS} = 44V
Q _{gd}	Gate-to-Drain ("Miller") Charge	—	—	41		V _{GS} = 10V, See Fig. 6 and 13 ④⑧
t _{d(on)}	Turn-On Delay Time	—	13	—		ns
t _r	Rise Time	—	76	—	I _D = 43A	
t _{d(off)}	Turn-Off Delay Time	—	39	—	R _G = 3.6Ω	
t _f	Fall Time	—	48	—	V _{GS} = 10V, See Fig. 10 ④⑧	
L _D	Internal Drain Inductance	—	4.5	—	nH	Between lead, 6mm (0.25in.) from package and center of die contact
L _S	Internal Source Inductance	—	7.5	—		
C _{iss}	Input Capacitance	—	3210	—	pF	V _{GS} = 0V
C _{oss}	Output Capacitance	—	690	—		V _{DS} = 25V
C _{rss}	Reverse Transfer Capacitance	—	140	—		f = 1.0MHz, See Fig. 5 ⑧
E _{AS}	Single Pulse Avalanche Energy②⑧	—	1030⑤	250⑥		mJ

Source-Drain Ratings and Characteristics

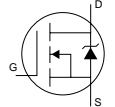
	Parameter	Min.	Typ.	Max.	Units	Conditions
I _S	Continuous Source Current (Body Diode)	—	—	85⑦	A	MOSFET symbol showing the integral reverse p-n junction diode. 
I _{SM}	Pulsed Source Current (Body Diode)①	—	—	290		
V _{SD}	Diode Forward Voltage	—	—	1.3	V	T _J = 25°C, I _S = 43A, V _{GS} = 0V ④
t _{rr}	Reverse Recovery Time	—	69	100	ns	T _J = 25°C, I _F = 43A
Q _{rr}	Reverse Recovery Charge	—	220	230	nC	di/dt = 100A/μs ④⑧
t _{on}	Forward Turn-On Time	Intrinsic turn-on time is negligible (turn-on is dominated by L _S +L _D)				

Notes:

- ① Repetitive rating; pulse width limited by max. junction temperature. (See fig. 11)
- ② Starting T_J = 25°C, L = 270μH
R_G = 25Ω, I_{AS} = 43A, V_{GS} = 10V (See Figure 12)
- ③ I_{SD} ≤ 43A, di/dt ≤ 210A/μs, V_{DD} ≤ V_{(BR)DSS},
T_J ≤ 175°C
- ④ Pulse width ≤ 400μs; duty cycle ≤ 2%.
- ⑤ This is a typical value at device destruction and represents operation outside rated limits.

- ⑥ This is a calculated value limited to T_J = 175°C .
 - ⑦ Calculated continuous current based on maximum allowable junction temperature. Package limitation current is 75A.
 - ⑧ Uses IRF1010N data and test conditions.
- ** When mounted on 1" square PCB (FR-4 or G-10 Material).
For recommended footprint and soldering techniques refer to application note #AN-994.

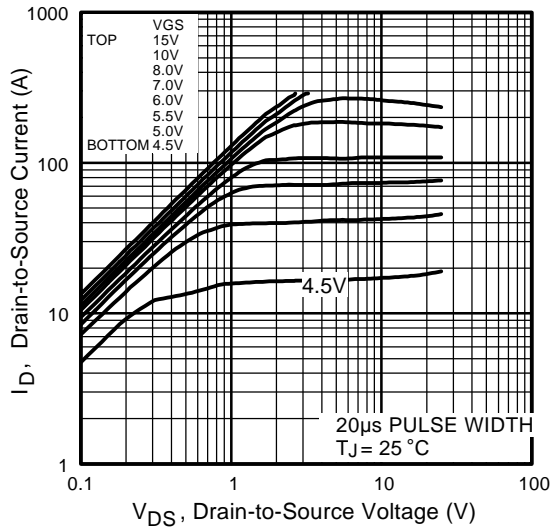

Fig 1. Typical Output Characteristics

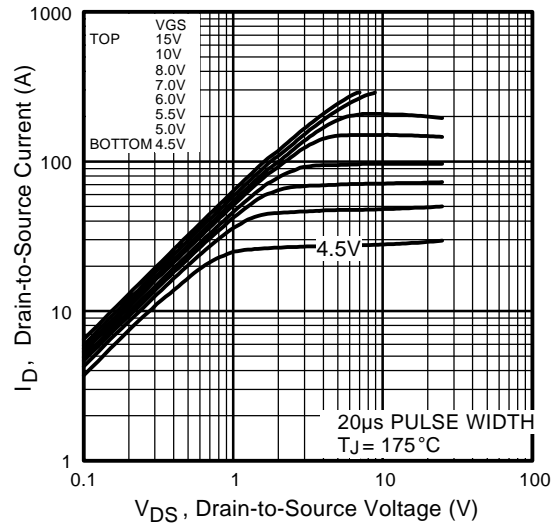

Fig 2. Typical Output Characteristics

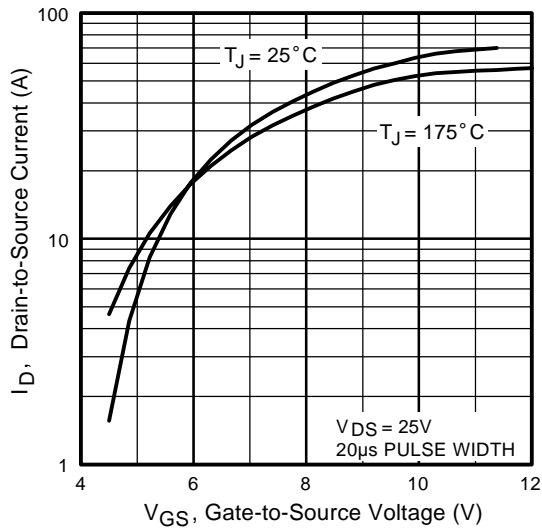

Fig 3. Typical Transfer Characteristics

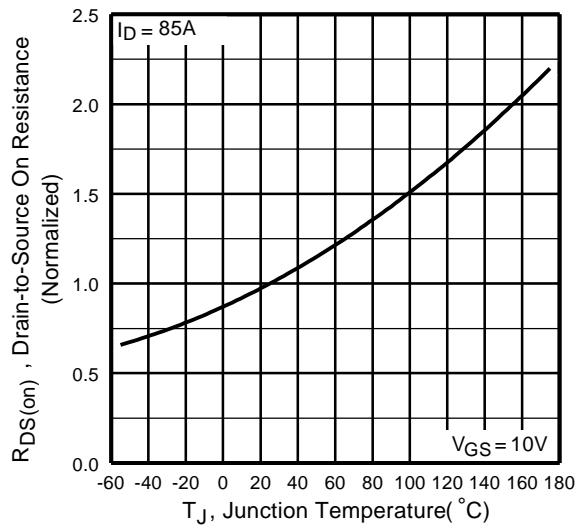

Fig 4. Normalized On-Resistance Vs. Temperature

IRF1010NS/IRF1010NL

International
IR Rectifier

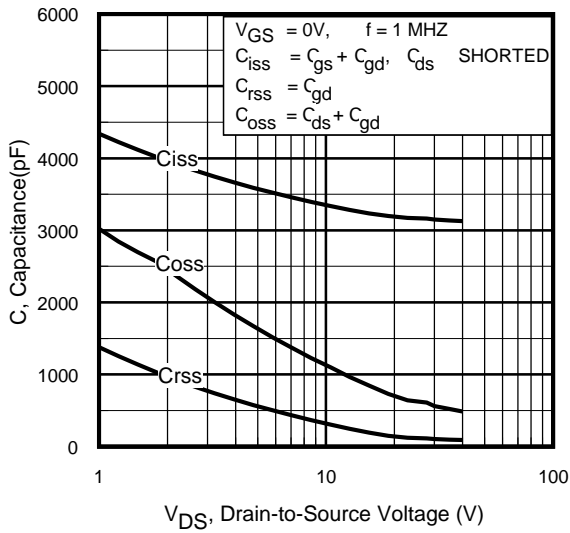

Fig 5. Typical Capacitance Vs. Drain-to-Source Voltage

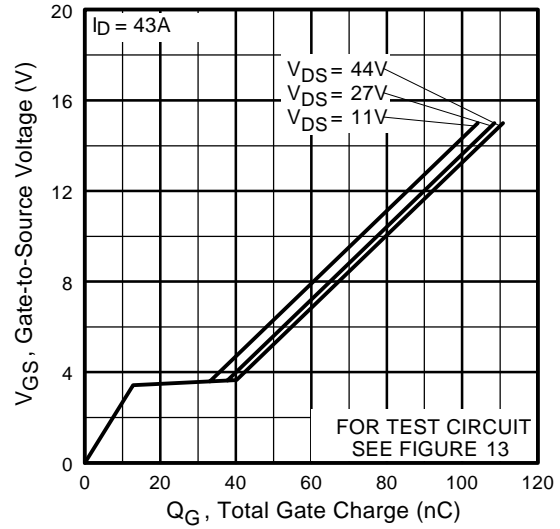

Fig 6. Typical Gate Charge Vs. Gate-to-Source Voltage

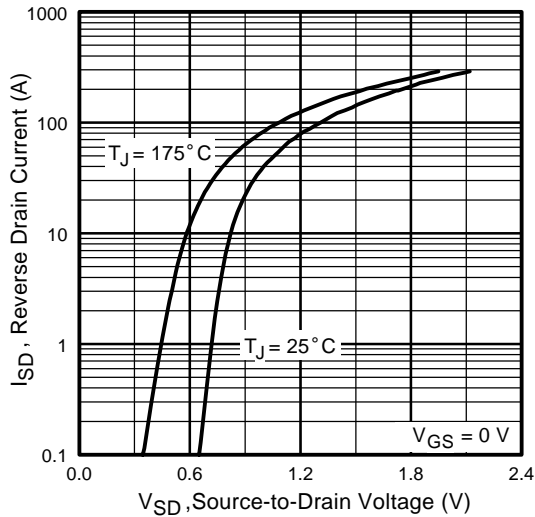

Fig 7. Typical Source-Drain Diode Forward Voltage

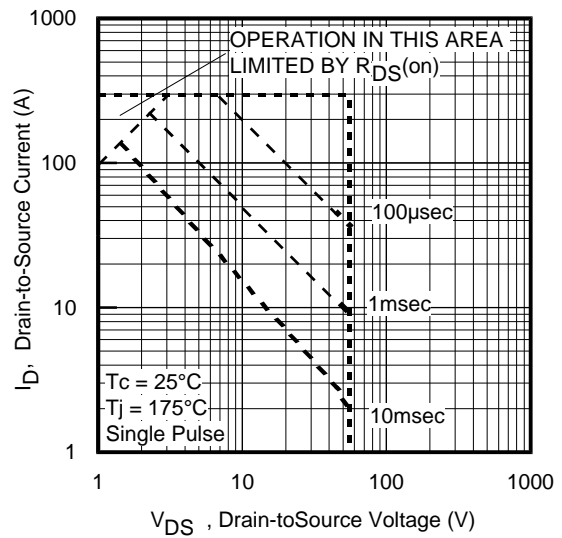

Fig 8. Maximum Safe Operating Area

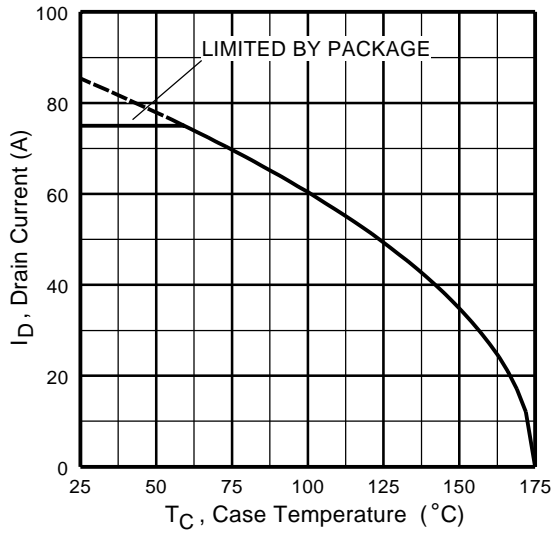

Fig 9. Maximum Drain Current Vs. Case Temperature

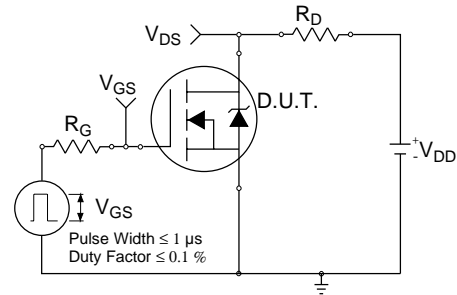

Fig 10a. Switching Time Test Circuit

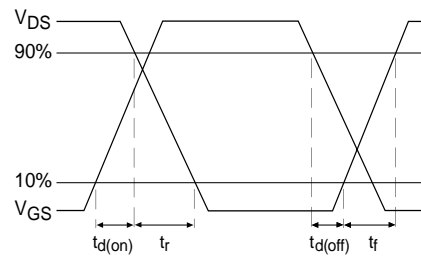

Fig 10b. Switching Time Waveforms

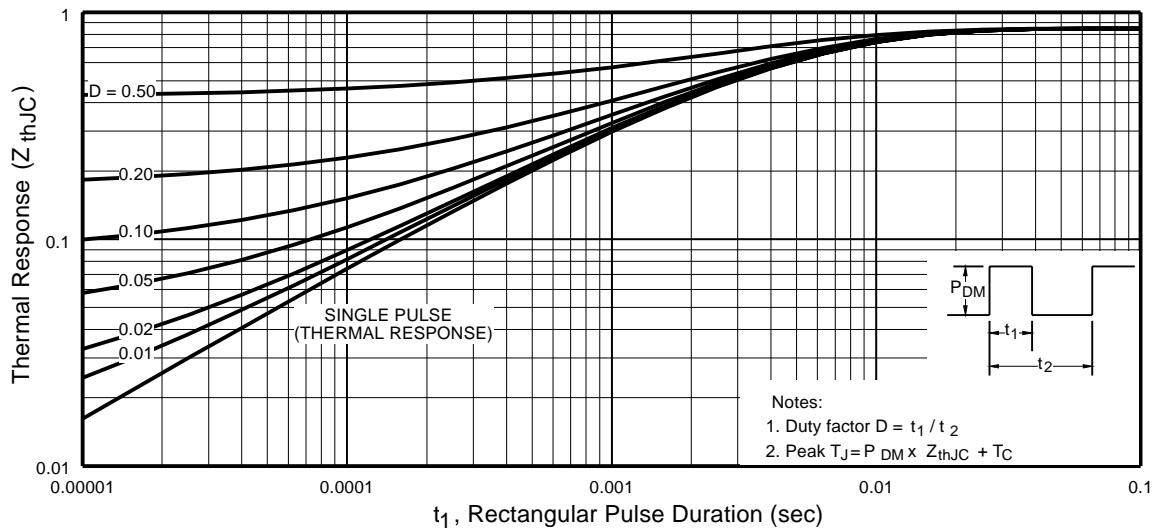

Fig 11. Maximum Effective Transient Thermal Impedance, Junction-to-Case

IRF1010NS/IRF1010NL

International
IR Rectifier

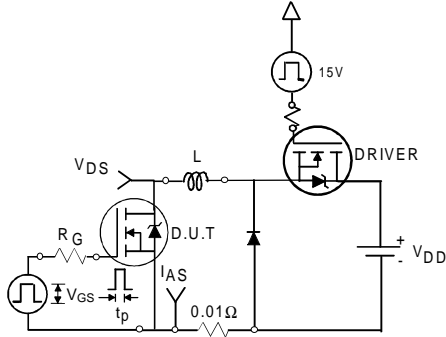

Fig 12a. Unclamped Inductive Test Circuit

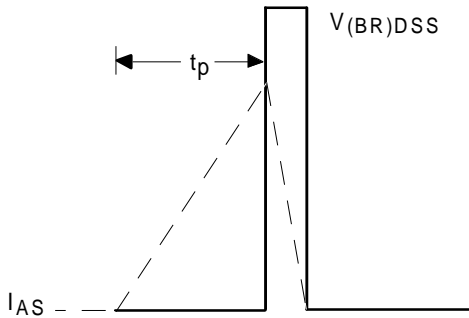

Fig 12b. Unclamped Inductive Waveforms

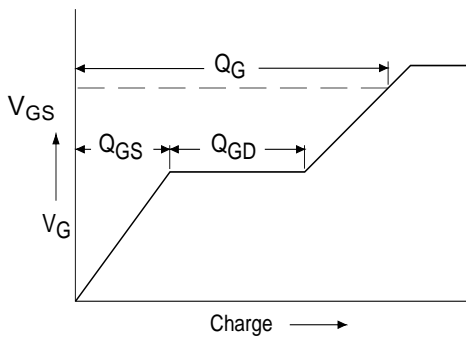

Fig 13a. Basic Gate Charge Waveform

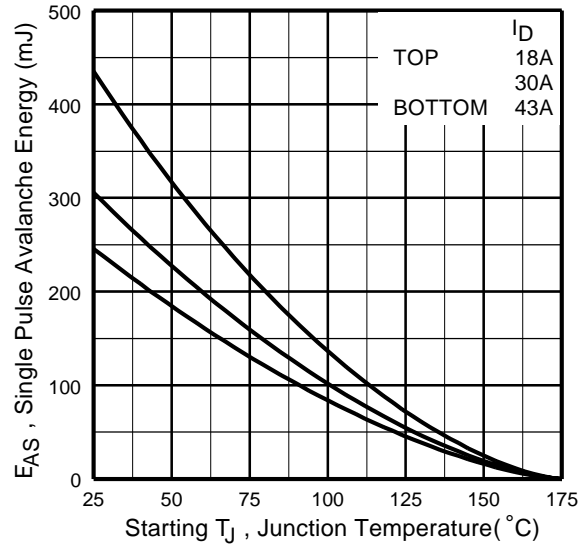

Fig 12c. Maximum Avalanche Energy Vs. Drain Current

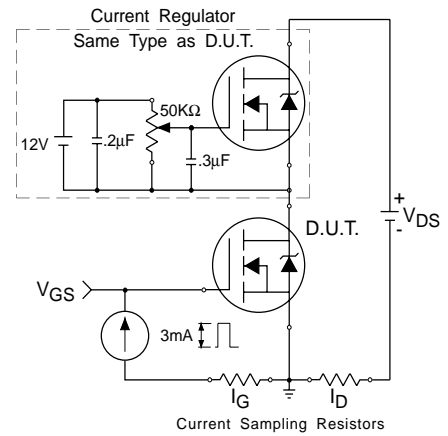
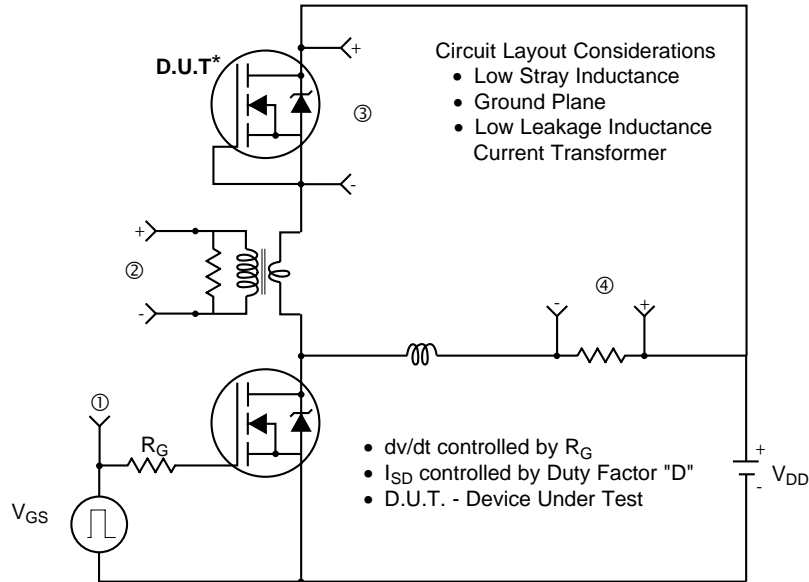
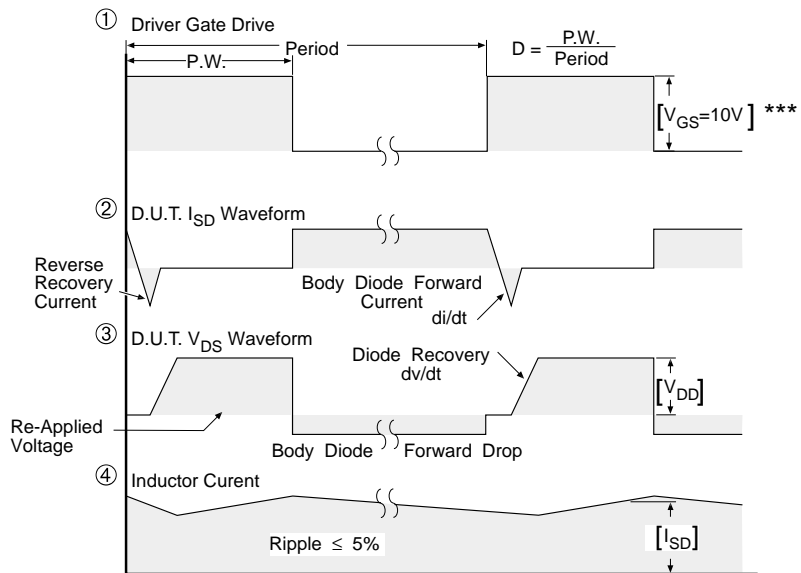

Fig 13b. Gate Charge Test Circuit

Peak Diode Recovery dv/dt Test Circuit



* Reverse Polarity of D.U.T for P-Channel



*** $V_{GS} = 5.0V$ for Logic Level and 3V Drive Devices

Fig 14. For N-channel HEXFET[®] power MOSFETs

IRF1010NS/IRF1010NL

International
IR Rectifier

D²Pak Package Outline

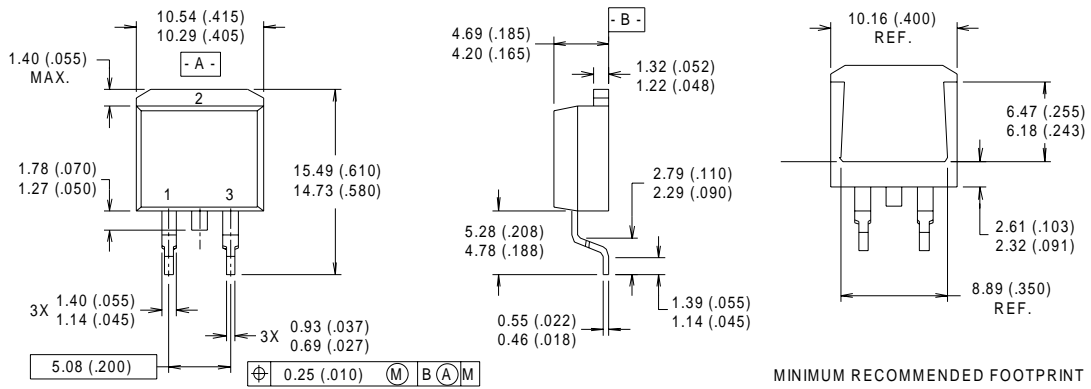

NOTES:

- 1 DIMENSIONS AFTER SOLDER DIP.
- 2 DIMENSIONING & TOLERANCING PER ANSI Y14.5M, 1982.
- 3 CONTROLLING DIMENSION : INCH.
- 4 HEATSINK & LEAD DIMENSIONS DO NOT INCLUDE BURRS.

LEAD ASSIGNMENTS

- 1 - GATE
- 2 - DRAIN
- 3 - SOURCE

Part Marking Information

D²Pak

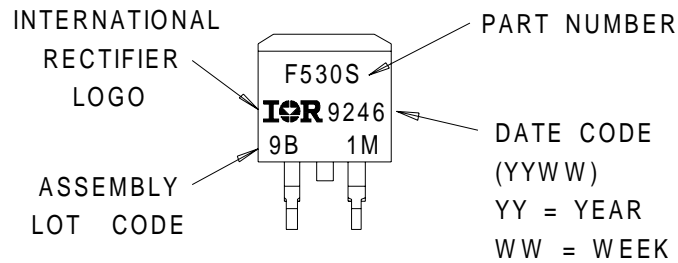

Package Outline

TO-262 Outline

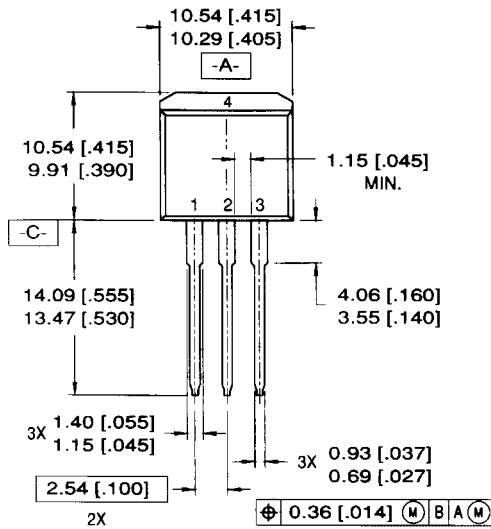

LEAD ASSIGNMENTS

1 = GATE	3 = SOURCE
2 = DRAIN	4 = DRAIN

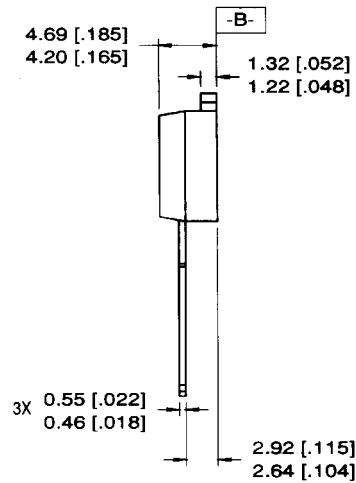

NOTES:

1. DIMENSIONING & TOLERANCING PER ANSI Y14.5M-1982
2. CONTROLLING DIMENSION: INCH.
3. DIMENSIONS ARE SHOWN IN MILLIMETERS [INCHES].
4. HEATSINK & LEAD DIMENSIONS DO NOT INCLUDE BURRS.

Part Marking Information

TO-262

EXAMPLE: THIS IS AN IRL3103L
 LOT CODE 1789
 ASSEMBLED ON WW 19, 1997
 IN THE ASSEMBLY LINE "C"

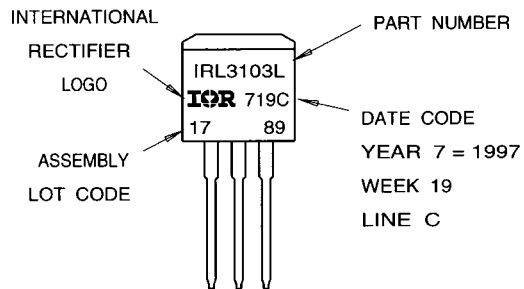

IRF1010NS/IRF1010NL

International
IR Rectifier

Tape & Reel Information D²Pak

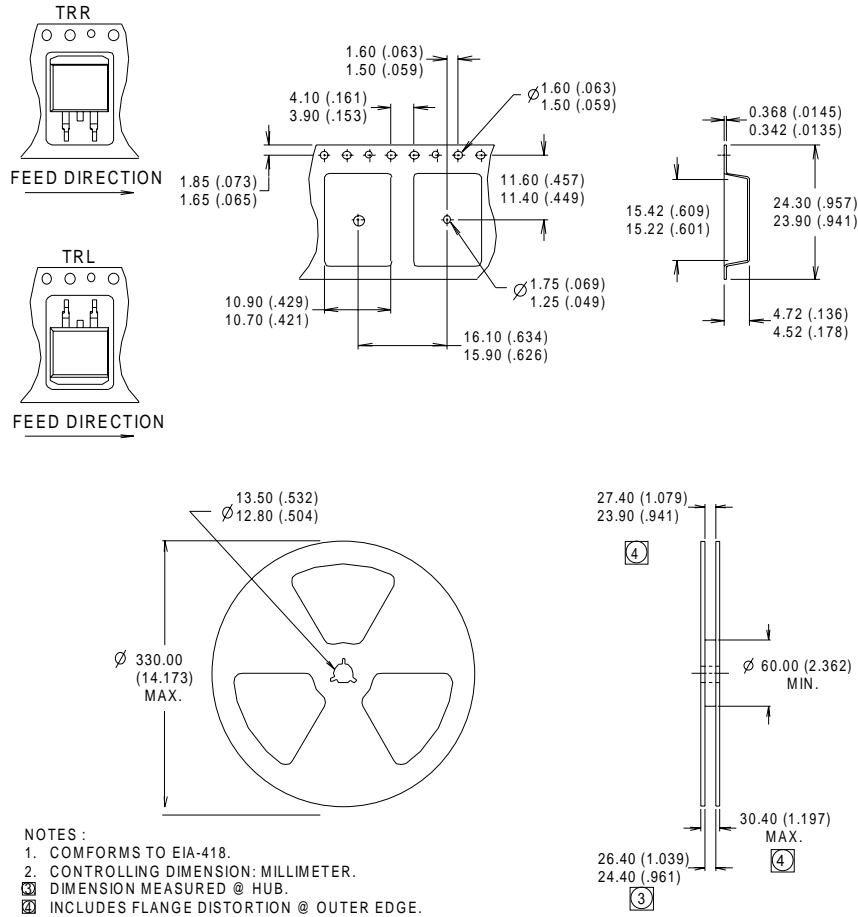

Data and specifications subject to change without notice.
This product has been designed and qualified for the Industrial market.
Qualification Standards can be found on IR's Web site.

International
IR Rectifier

IR WORLD HEADQUARTERS: 233 Kansas St., El Segundo, California 90245, USA Tel: (310) 252-7105
TAC Fax: (310) 252-7903

Visit us at www.irf.com for sales contact information. 02/02

www.irf.com



LittleDiode supplies new, hard to find or obsolete electronic components and semiconductors all over the world.

With over two million different components listed you are sure to find the part you need.

Feel free to visit us today at our online store:

LittleDiode.com

Looking forward to providing you with the best possible service.