

# Agilent CNY17-x Phototransistor Optocoupler High Collector-Emitter Voltage Type Data Sheet

## Description

The CNY17 contains a light emitting diode optically coupled to a phototransistor. It is packaged in a 6-pin DIP package and available in wide-lead spacing option and lead bend SMD option. Collector-emitter voltage is above 70 V. Response time,  $t_r$ , is typically 5  $\mu$ s and minimum CTR is 40% at input current of 10 mA.

## Ordering Information

Specify part number followed by Option Number (if desired).

CNY17-3-XXXX  
 └───┬───┬───  
 Lead Free  
 Option Number

000 = No Options  
 060 = IEC/EN/DIN EN 60747-5-2  
 Option  
 W00 = 0.4" Lead Spacing Option  
 300 = Lead Bend SMD Option  
 500 = Tape and Reel Packaging  
 Option

## Features

- High collector-emitter voltage ( $V_{CE0} = 70V$ )
- High input-output isolation voltage ( $V_{iso} = 5000V_{rms}$ )
- Current Transfer Ratio (CTR: min. 40% at  $I_F = 10\text{ mA}$ ,  $V_{CE} = 5V$ )
- Response time ( $t_r$ : typ., 5  $\mu$ s at  $V_{CC} = 10V$ ,  $I_C = 2\text{ mA}$ ,  $R_L = 100\ \Omega$ )
- Dual-in-line package
- UL approved
- CSA approved
- IEC/EN/DIN EN 60747-5-2 approved
- Options available:
  - Leads with 0.4" (10.16 mm) spacing (W00)
  - Leads bends for surface mounting (300)
  - Tape and reel for SMD (500)
  - IEC/EN/DIN EN 60747-5-2 approvals (060)

## Functional Diagram

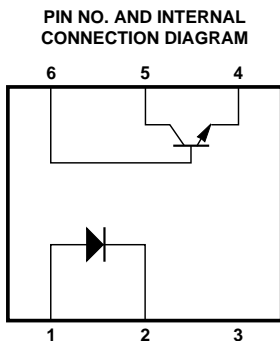

1. ANODE      4. EMITTER  
 2. CATHODE   5. COLLECTOR  
 3. NC        6. BASE

## Schematic

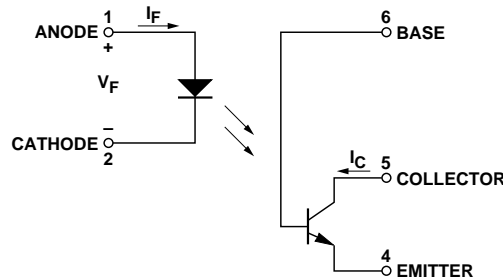

## Applications

- System appliances, measuring instruments
- Signal transmission between circuits of different potentials and impedances
- Feedback circuit in power supply

**CAUTION:** It is advised that normal static precautions be taken in handling and assembly of this component to prevent damage and/or degradation which may be induced by ESD.

**Package Outline Drawings**  
**CNY17-X-000E**

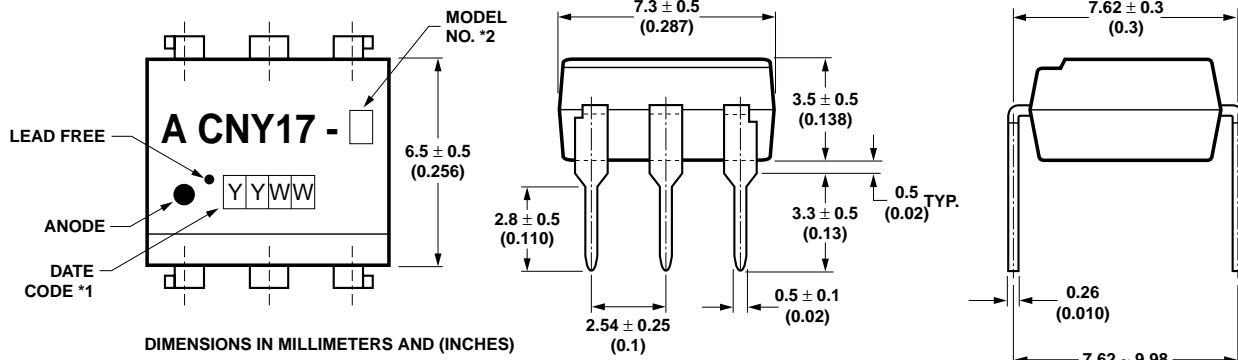

**CNY17-X-060E**

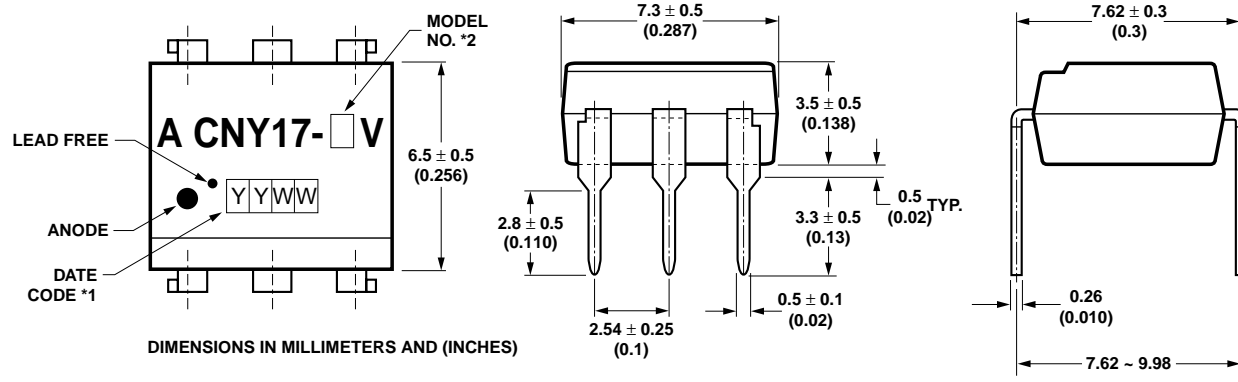

**CNY17-X-W00E**

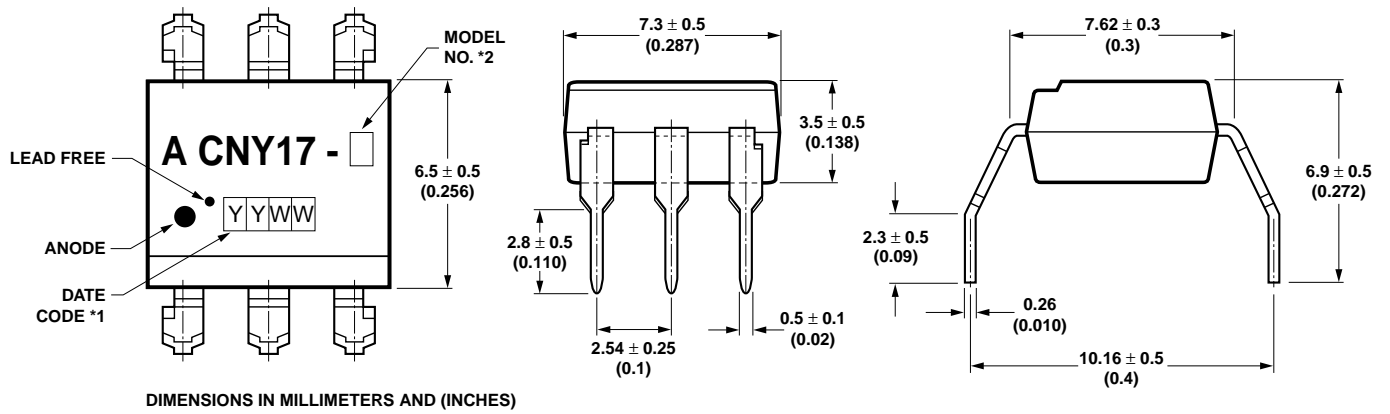

## CNY17-X-300E

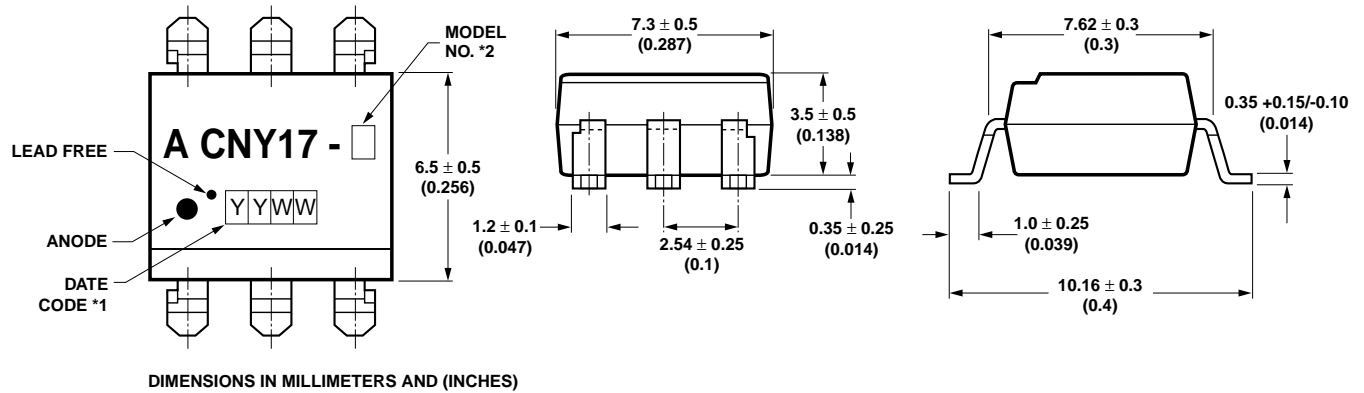

### Solder Reflow Temperature Profile

- 1) One-time soldering reflow is recommended within the condition of temperature and time profile shown at right.
- 2) When using another soldering method such as infrared ray lamp, the temperature may rise partially in the mold of the device. Keep the temperature on the package of the device within the condition of (1) above.

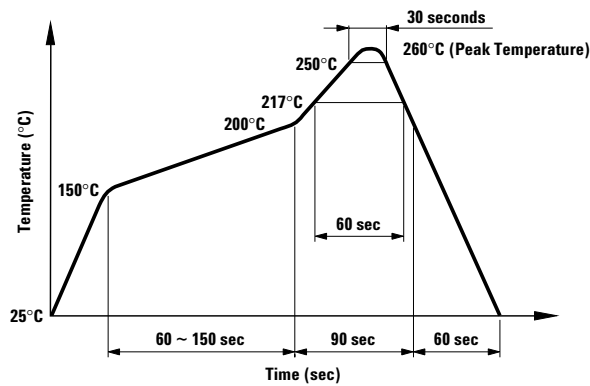

### Absolute Maximum Ratings

Storage Temperature, $T_S$	$-55^{\circ}\text{C}$ to $+150^{\circ}\text{C}$
Operating Temperature, $T_A$	$-55^{\circ}\text{C}$ to $+100^{\circ}\text{C}$
Lead Solder Temperature, max. (1.6 mm below seating plane)	$260^{\circ}\text{C}$ for 10 s
Average Forward Current, $I_F$	60 mA
Reverse Input Voltage, $V_R$	6 V
Input Power Dissipation, $P_I$	100 mW
Collector Current, $I_C$	150 mA
Collector-Emitter Voltage, $V_{CE0}$	70 V
Emitter-Collector Voltage, $V_{EC0}$	6 V
Collector-Base Voltage, $V_{CB0}$	70 V
Collector Power Dissipation	150 mW
Total Power Dissipation	250 mW
Isolation Voltage, $V_{iso}$ (AC for 1 minute, R.H. = 40 ~ 60%)	5000 Vrms

**Electrical Specifications (T<sub>A</sub> = 25 °C)**

Parameter	Symbol	Min.	Typ.	Max.	Units	Test Conditions
Forward Voltage	V <sub>F</sub>	–	1.4	1.7	V	I <sub>F</sub> = 60 mA
Reverse Current	I <sub>R</sub>	–	–	10	μA	V <sub>R</sub> = 6 V
Terminal Capacitance	C <sub>t</sub>	–	–	100	pF	V = 0, f = 1 MHz
Collector Dark Current	I <sub>CEO</sub>	–	–	50	nA	V <sub>CE</sub> = 10 V
Collector-Emitter Breakdown Voltage	BV <sub>CEO</sub>	70	–	–	V	I <sub>C</sub> = 0.1 mA, I <sub>F</sub> = 0
Emitter-Collector Breakdown Voltage	BV <sub>ECO</sub>	6	–	–	V	I <sub>E</sub> = 10 μA, I <sub>F</sub> = 0
Collector-Base Breakdown Voltage	BV <sub>CBO</sub>	70	–	–	V	I <sub>C</sub> = 0.1 mA, I <sub>F</sub> = 0
Collector Current	I <sub>C</sub>	4	–	32	mA	I <sub>F</sub> = 10 mA
*Current Transfer Ratio	CNY17-1 CNY17-2 CNY17-3 CNY17-4	CTR	40 63 100 160	– – – –	80 125 200 320	% V <sub>CE</sub> = 5 V
Collector-Emitter Saturation Voltage	V <sub>CE(sat)</sub>	–	–	0.3	V	I <sub>F</sub> = 10 mA, I <sub>C</sub> = 2.5 mA
Response Time (Rise)	t <sub>r</sub>	–	5	10	μs	V <sub>CE</sub> = 5 V, I <sub>C</sub> = 10 mA
Response Time (Fall)	t <sub>f</sub>	–	5	10	μs	R <sub>L</sub> = 100 Ω
Isolation Resistance	R <sub>iso</sub>	1 x 10 <sup>11</sup>	–	–	Ω	DC 500 V 40 ~ 60% R.H.
Floating Capacitance	C <sub>f</sub>	–	–	2	pF	V = 0, f = 1 MHz

\* CTR =  $\frac{I_C}{I_F} \times 100\%$

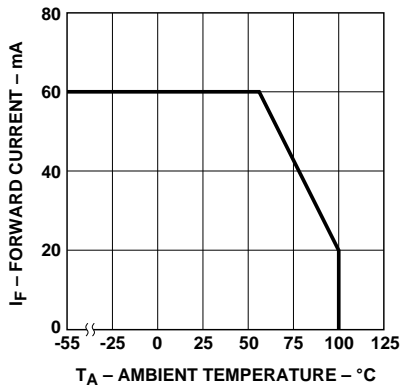

Figure 1. Forward current vs. temperature.

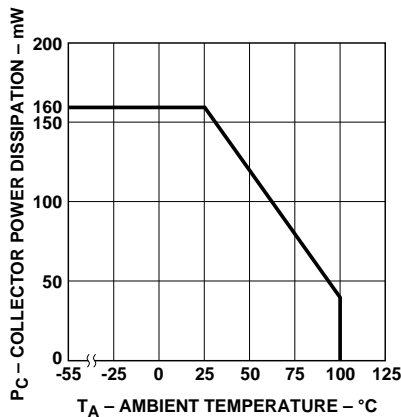

Figure 2. Collector power dissipation vs. temperature.

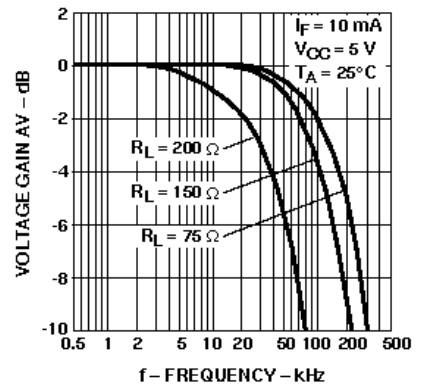

Figure 3. Frequency response.

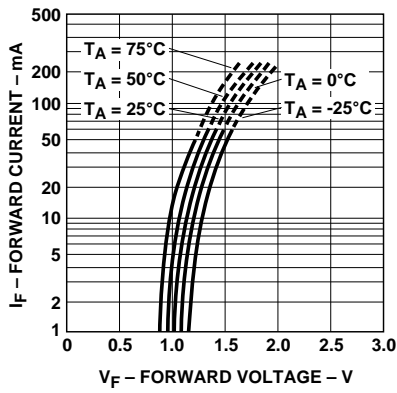

Figure 4. Forward current vs. forward voltage.

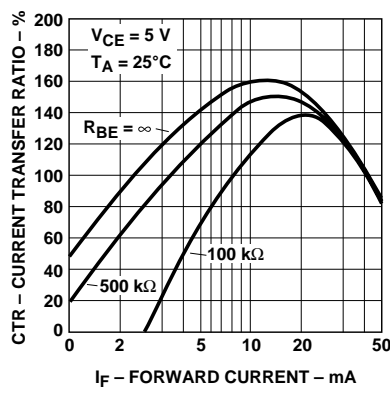

Figure 5. Current transfer ratio vs. forward current.

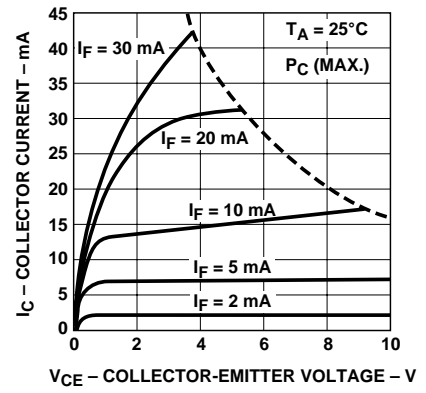

Figure 6. Collector current vs. collector-emitter voltage.

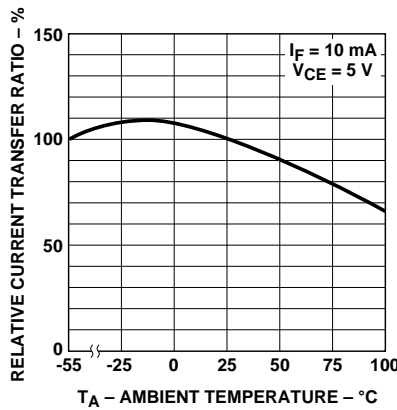

Figure 7. Relative current transfer ratio vs. temperature.

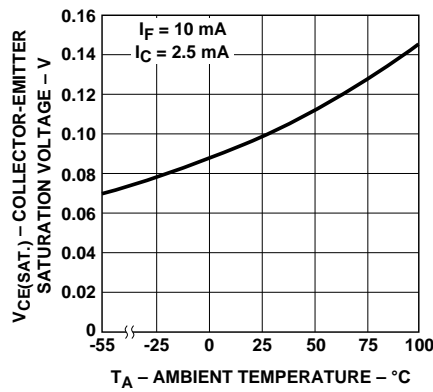

Figure 8. Collector-emitter saturation voltage vs. temperature.

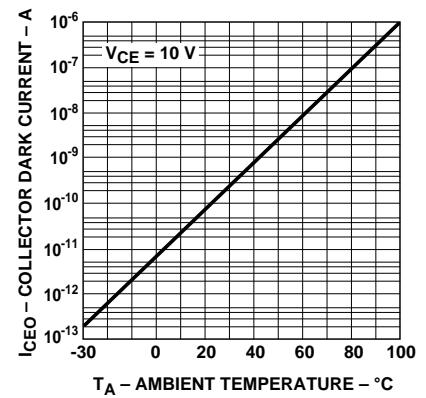

Figure 9. Collector dark current vs. temperature.

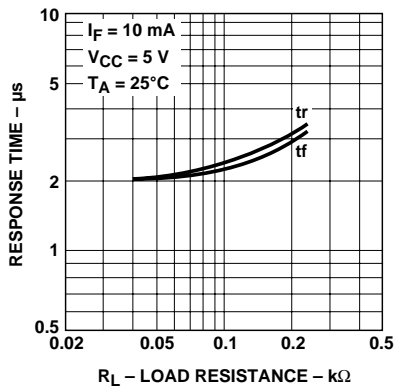

Figure 10. Response time vs. load resistance.

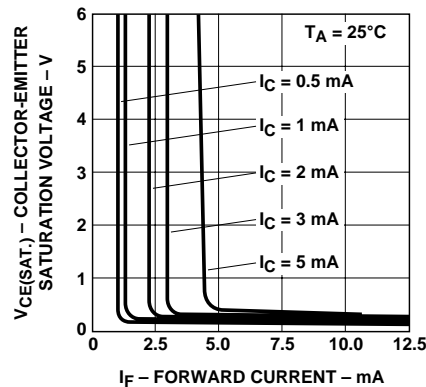
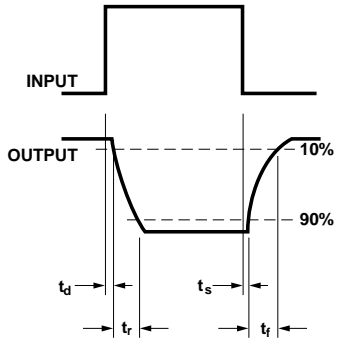
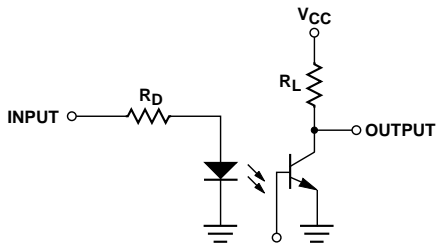
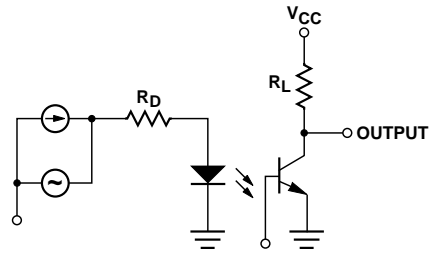

Figure 11. Collector-emitter saturation voltage vs. forward current.

## Test Circuit for Response Time



## Test Circuit for Frequency Response



## [www.agilent.com/semiconductors](http://www.agilent.com/semiconductors)

For product information and a complete list of distributors, please go to our web site.

For technical assistance call:

Americas/Canada: +1 (800) 235-0312 or (916) 788-6763

Europe: +49 (0) 6441 92460

China: 10800 650 0017

Hong Kong: (+65) 6756 2394

India, Australia, New Zealand: (+65) 6755 1939

Japan: (+81 3) 3335-8152 (Domestic/International), or 0120-61-1280 (Domestic Only)

Korea: (+65) 6755 1989

Singapore, Malaysia, Vietnam, Thailand, Philippines, Indonesia: (+65) 6755 2044

Taiwan: (+65) 6755 1843

Data subject to change.

Copyright © 2004 Agilent Technologies, Inc.

Obsoletes 5989-0290EN

October 27, 2004

5989-1736EN



**Agilent Technologies**



LittleDiode supplies new, hard to find or obsolete electronic components and semiconductors all over the world.

With over two million different components listed you are sure to find the part you need.

Feel free to visit us today at our online store:

[LittleDiode.com](http://LittleDiode.com)

Looking forward to providing you with the best possible service.