

Features

- N-channel dual-gate GaAs MES FET
- Depletion mode transistor for tuned small-signal applications up to 2 GHz, e. g. VHF, UHF, Sat-TV tuners
- Low noise
- High gain
- Low input capacitance

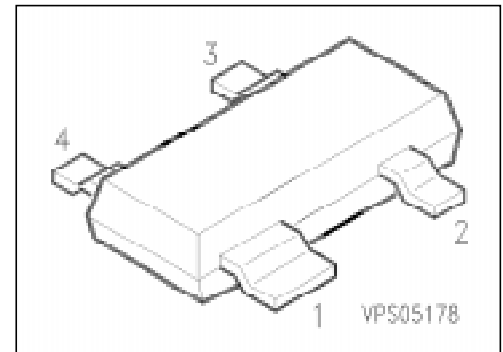

ESD: Electrostatic discharge sensitive device, observe handling precautions!

Type	Marking	Ordering Code (tape and reel)	Pin Configuration				Package ¹⁾
			1	2	3	4	
CF 739	MS	Q62702-F1215	S	D	G ₂	G ₁	SOT-143

Maximum Ratings

Parameter	Symbol	Values	Unit
Drain-source voltage	V_{DS}	10	V
Gate 1-source voltage	$-V_{G1S}$	6	
Gate 2-source voltage	$-V_{G2S}$	6	
Drain current	I_D	80	mA
Gate 1-source peak current	$+I_{G1SM}$	1	
Gate 2-source peak current	$+I_{G2SM}$	1	
Total power dissipation, $T_s \leq 66 \text{ }^\circ\text{C}^2)$	P_{tot}	240	mW
Channel temperature	T_{ch}	150	$^\circ\text{C}$
Storage temperature range	T_{stg}	- 55 ... + 150	

Thermal Resistance

Channel - soldering point ³⁾	R_{thchS}	≤ 350	K/W
---	-------------	------------	-----

¹⁾ For detailed information see chapter Package Outlines.

²⁾ Package mounted on alumina 15 mm × 16.7 mm × 0.7 mm.

³⁾ T_s is measured on the source lead at the soldering point to the pcb.

Electrical Characteristics

at $T_A = 25\text{ °C}$, unless otherwise specified.

Parameter	Symbol	Values			Unit
		min.	typ.	max.	

DC Characteristics

Drain-source breakdown voltage $I_D = 100\text{ }\mu\text{A}$, $-V_{G1S} = -V_{G2S} = 4\text{ V}$	$V_{(BR)DS}$	10	–	–	V
Gate 1 leakage current $-V_{G1S} = 5\text{ V}$, $V_{G2S} = V_{DS} = 0$	$-I_{G1SS}$	–	–	20	μA
Gate 2 leakage current $-V_{G2S} = 5\text{ V}$, $V_{G1S} = V_{DS} = 0$	$-I_{G2SS}$	–	–	20	
Drain current $V_{G1S} = 0$, $V_{G2S} = 0$, $V_{DS} = 3\text{ V}$	I_{DSS}	6	–	60	mA
Gate 1-source pinch-off voltage $V_{G2S} = 0$, $V_{DS} = 5\text{ V}$, $I_D = 200\text{ }\mu\text{A}$	$-V_{G1S(P)}$	–	–	2.5	V
Gate 2-source pinch-off voltage $V_{G1S} = 0$, $V_{DS} = 5\text{ V}$, $I_D = 200\text{ }\mu\text{A}$	$-V_{G2S(P)}$	–	–	2.5	

AC Characteristics

Forward transconductance $V_{DS} = 5\text{ V}$, $V_{G2S} = 2\text{ V}$, $I_D = 10\text{ mA}$, $f = 1\text{ kHz}$	g_{fs}	–	25	–	mS
Gate 1 input capacitance $V_{G2S} = 2\text{ V}$, $V_{DS} = 5\text{ V}$, $I_D = 10\text{ mA}$, $f = 1\text{ MHz}$	C_{gfss}	–	0.95	–	pF
Output capacitance $V_{G2S} = 2\text{ V}$, $V_{DS} = 5\text{ V}$, $I_D = 10\text{ mA}$, $f = 1\text{ MHz}$	C_{dss}	–	0.5	–	
Noise figure $V_{G2S} = 2\text{ V}$, $V_{DS} = 5\text{ V}$, $I_D = 10\text{ mA}$, $f = 1.75\text{ GHz}$ $V_{G2S} = 2\text{ V}$, $V_{DS} = 5\text{ V}$, $I_D = 10\text{ mA}$, $f = 800\text{ MHz}$	F	–	1.8	–	dB
		–	1.1	–	
Power gain $V_{G2S} = 2\text{ V}$, $V_{DS} = 5\text{ V}$, $I_D = 10\text{ mA}$, $f = 1.75\text{ GHz}$ $V_{G2S} = 2\text{ V}$, $V_{DS} = 5\text{ V}$, $I_D = 10\text{ mA}$, $f = 800\text{ MHz}$	G_{ps}	–	17	–	
		–	22	–	
Control range $V_{G2S} = 2\text{ V} \dots -3\text{ V}$	ΔG_{psc}	–	50	–	

Total power dissipation $P_{tot} = f(T_A^*; T_S)$

*Package mounted on alumina

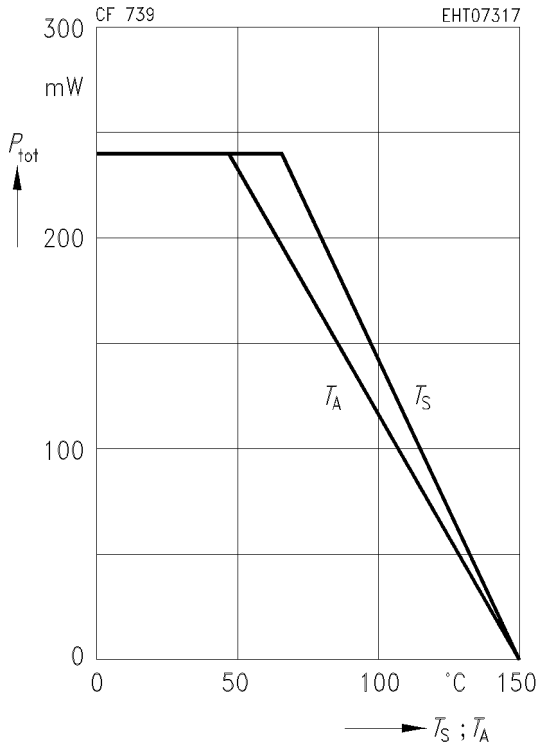

Output characteristics $I_D = f(V_{DS})$

$V_{G2S} = 2\text{ V}$

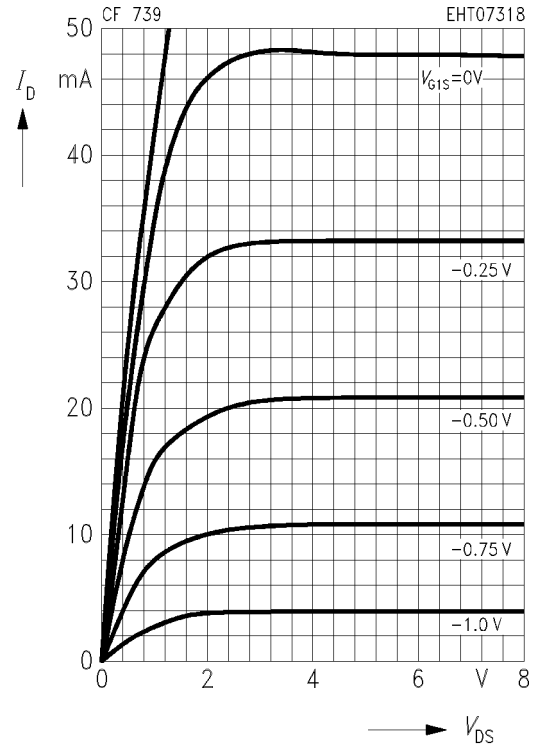

Gate 1 forward transconductance $g_{fs1} = f(V_{G1S})$

$V_{DS} = 5\text{ V}, f = 1\text{ kHz}$

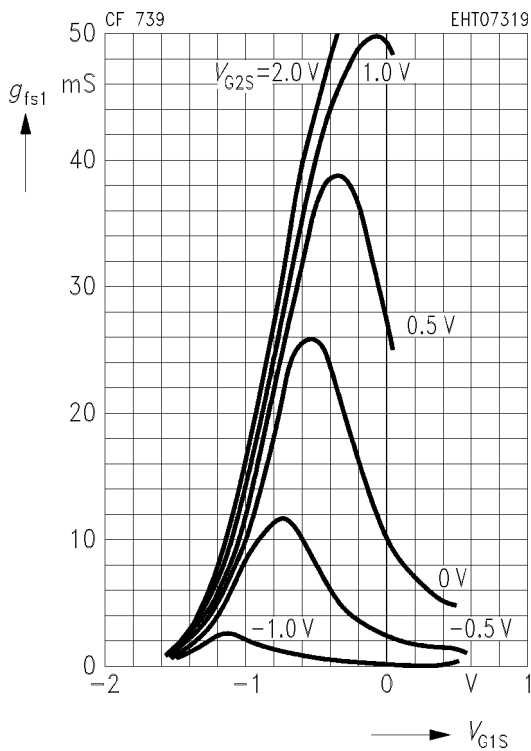

Gate 1 forward transconductance $g_{fs1} = f(V_{G2S})$

$V_{DS} = 5\text{ V}, f = 1\text{ kHz}$

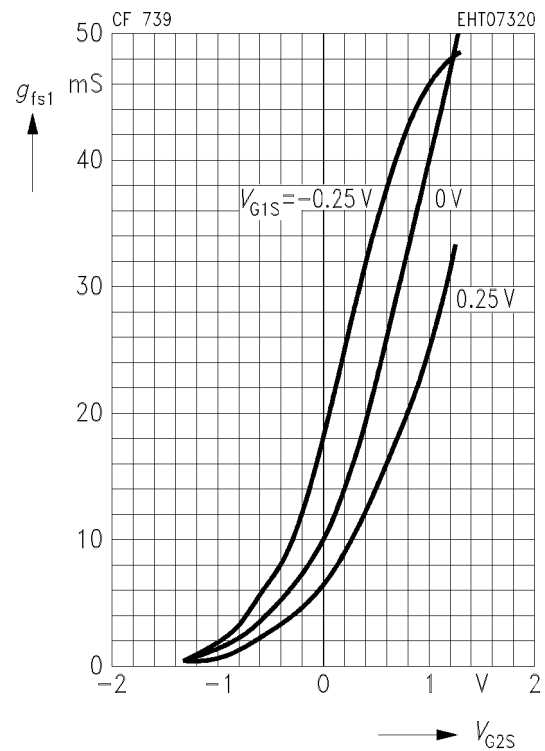

Drain current $I_D = f(V_{G1S})$

$V_{DS} = 5\text{ V}$

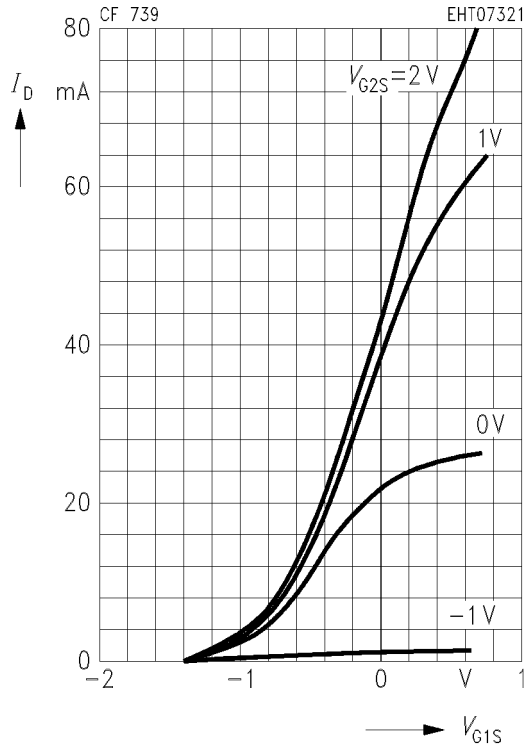

Drain current $I_D = f(V_{G2S})$

$V_{DS} = 5\text{ V}$

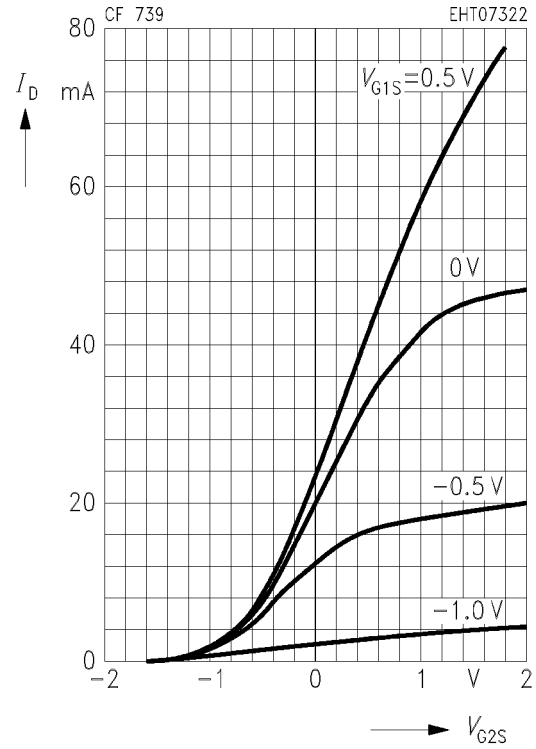

Gate 1 input transconductance

$C_{g1ss} = f(I_D)$

$V_{G2S} = 2\text{ V}, V_{DS} = 5\text{ V}, f = 0.1 - 1\text{ GHz}$

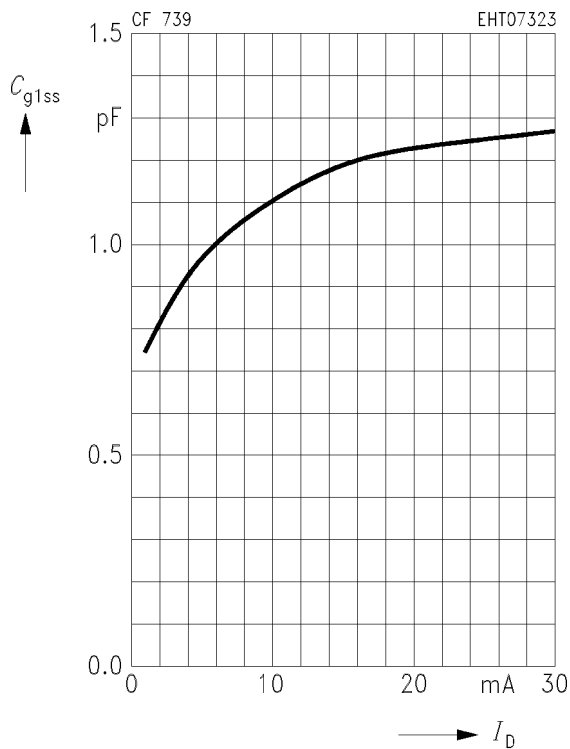

Output capacitance $C_{dss} = f(V_{DS})$

$V_{G2S} = 2\text{ V}, I_D = 10\text{ mA}, f = 0.1 - 1\text{ GHz}$

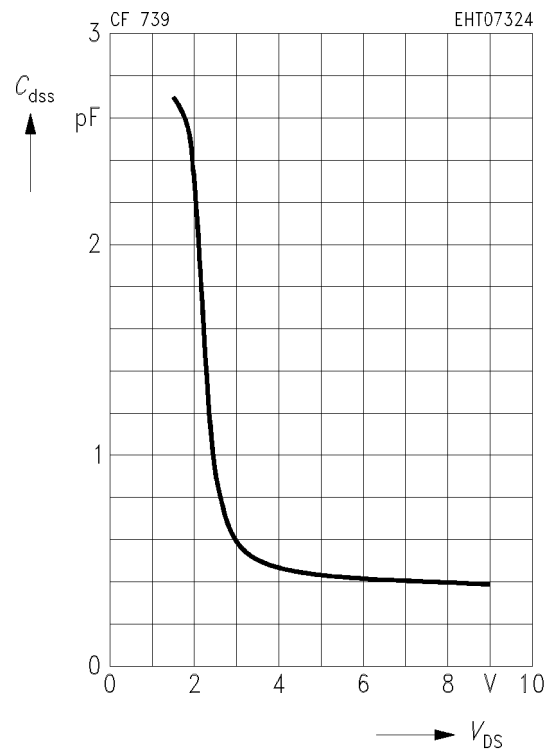

Common Source Admittance Parameters, G_2 RF grounded

Gate 1 input admittance y_{11s}

$V_{DS} = 5\text{ V}$, $V_{G2S} = 2\text{ V}$, $I_D = 10\text{ mA}$

Gate 1 forward transfer admittance y_{21s}

$V_{DS} = 5\text{ V}$, $V_{G2S} = 2\text{ V}$, $I_D = 10\text{ mA}$

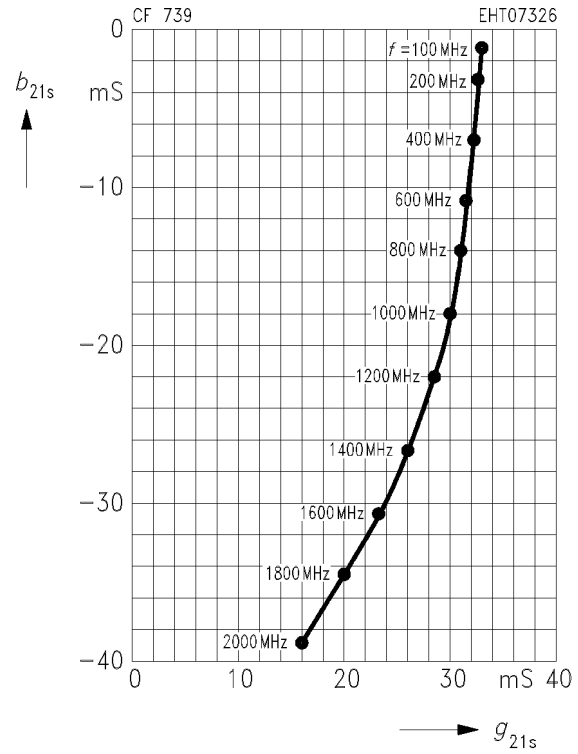
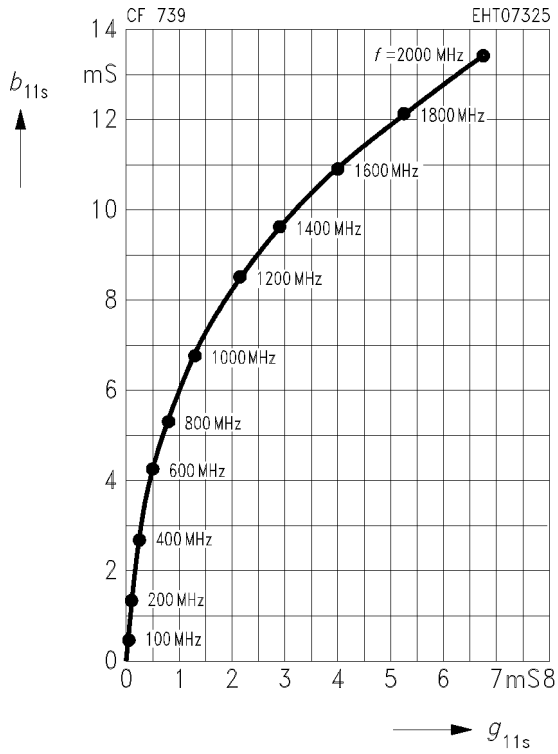

Output admittance y_{22s}

$V_{DS} = 5\text{ V}$, $V_{G2S} = 2\text{ V}$, $I_D = 10\text{ mA}$

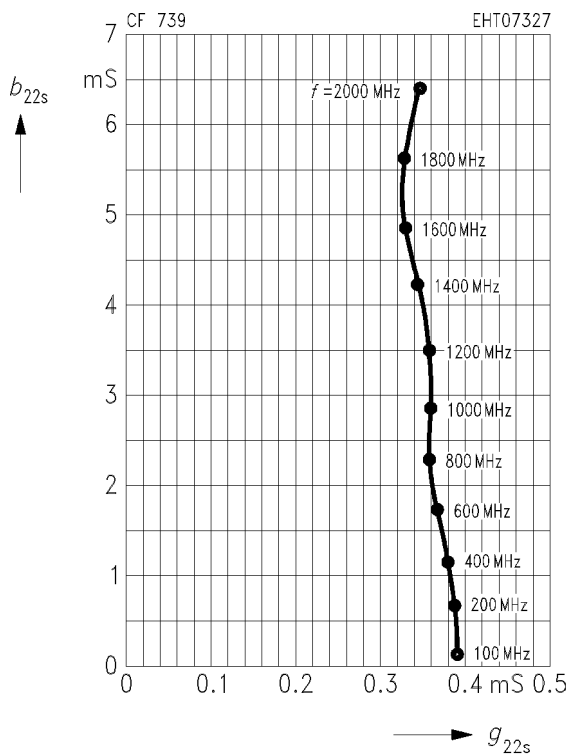

Common Source S-Parameters, G₂ RF grounded

<i>f</i>	<i>S</i> ₁₁		<i>S</i> ₂₁		<i>S</i> ₁₂		<i>S</i> ₂₂	
GHz	MAG	ANG	MAG	ANG	MAG	ANG	MAG	ANG
<i>V</i> _{DS} = 5 V, <i>V</i> _{G2S} = 2 V, <i>I</i> _D = 10 mA, <i>Z</i> ₀ = 50 Ω								
0.06	0.999	- 2.4	3.21	176.9	0.001	81.8	0.963	- 1.0
0.08	0.998	- 3.2	3.21	175.5	0.001	85.8	0.963	- 1.4
0.10	0.998	- 4.1	3.21	174.3	0.001	90.8	0.962	- 1.7
0.15	0.997	- 6.0	3.22	171.4	0.002	84.2	0.962	- 2.5
0.20	0.993	- 8.0	3.22	168.4	0.002	88.1	0.962	- 3.4
0.25	0.989	- 10.1	3.21	165.5	0.003	84.4	0.962	- 4.3
0.30	0.987	- 12.1	3.21	162.5	0.003	83.3	0.962	- 5.2
0.40	0.975	- 16.0	3.18	156.6	0.004	79.6	0.961	- 6.8
0.50	0.965	- 19.9	3.15	150.7	0.005	78.6	0.960	- 8.5
0.60	0.951	- 23.8	3.12	145.0	0.006	78.0	0.960	- 10.3
0.70	0.935	- 27.5	3.09	139.3	0.007	76.6	0.961	- 12.0
0.80	0.918	- 31.4	3.05	134.0	0.008	73.3	0.958	- 13.7
0.90	0.900	- 35.2	3.03	128.5	0.009	70.4	0.956	- 15.4
1.00	0.877	- 39.0	3.02	122.9	0.009	69.5	0.955	- 17.0
1.20	0.883	- 46.6	2.96	111.4	0.010	66.4	0.953	- 20.6
1.40	0.773	- 53.7	2.85	99.7	0.011	59.9	0.949	- 24.3
1.50	0.744	- 56.8	2.77	94.4	0.012	59.9	0.949	- 26.2
1.60	0.720	- 60.1	2.74	89.2	0.012	57.5	0.949	- 27.9
1.80	0.666	- 66.2	2.64	78.9	0.012	54.1	0.948	- 31.5
2.00	0.614	- 72.8	2.59	68.6	0.012	49.2	0.945	- 35.3
2.20	0.556	- 80.3	2.53	57.4	0.012	43.7	0.941	- 39.4
2.40	0.497	- 87.2	2.45	45.6	0.010	39.4	0.937	- 44.4
2.50	0.466	- 90.2	2.38	40.0	0.009	35.2	0.936	- 47.0
2.60	0.449	- 92.8	2.34	34.5	0.008	32.2	0.936	- 49.6
2.80	0.408	- 97.1	2.24	23.6	0.005	25.1	0.937	- 54.6
3.00	0.375	- 101.7	2.17	12.2	0.002	- 25.0	0.934	- 59.1

$S_{11}, S_{22} = f(f), Z\text{-plane}$

$V_{DS} = 5\text{ V}, V_{GS} = 2\text{ V}, I_D = 10\text{ mA}, Z_0 = 50\ \Omega$

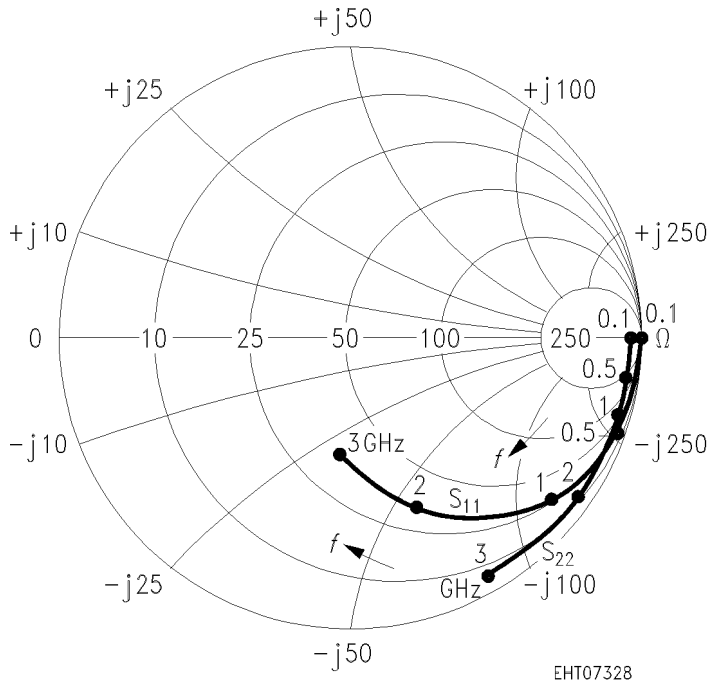

$S_{12}, S_{21} = f(f)$

$V_{DS} = 5\text{ V}, V_{GS} = 2\text{ V}, I_D = 10\text{ mA}, Z_0 = 50\ \Omega$

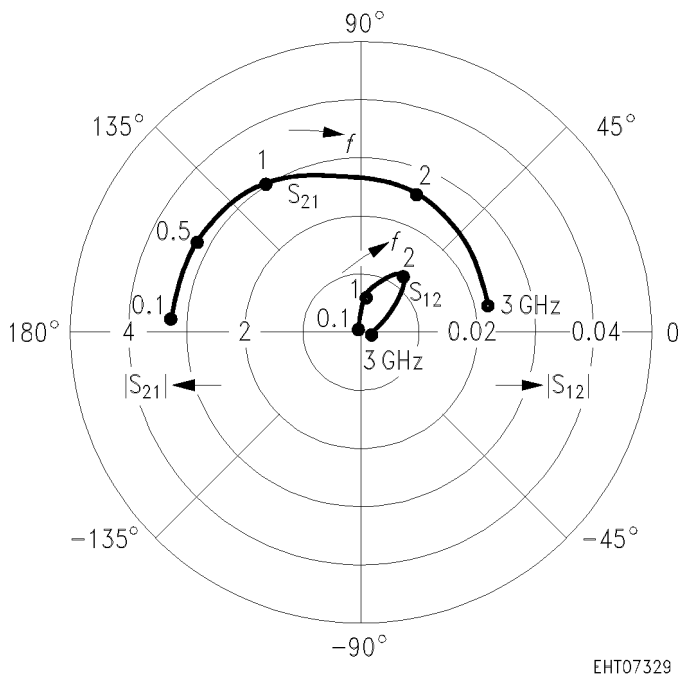



LittleDiode supplies new, hard to find or obsolete electronic components and semiconductors all over the world.

With over two million different components listed you are sure to find the part you need.

Feel free to visit us today at our online store:

LittleDiode.com

Looking forward to providing you with the best possible service.