

# CLC109

## Low-Power, Wideband, Closed-Loop Buffer

### General Description

The CLC109 is a high-performance, closed-loop monolithic buffer intended for power sensitive applications. Requiring only 35mW of quiescent power ( $\pm 5V$  supplies), the CLC109 offers a high bandwidth of 270MHz ( $0.5V_{pp}$ ) and a slew rate of  $350V/\mu s$ . Even with this minimal dissipation, the CLC109 can easily drive a demanding  $100\Omega$  load. The buffer specifications are for a  $100\Omega$  load.

With its patented closed-loop topology, the CLC109 has significant performance advantages over conventional open-loop designs. Applications requiring low ( $2.8\Omega$ ) output impedance and nearly ideal unity gain (0.997) through very high frequencies will benefit from the CLC109's superior performance. Power sensitive applications will benefit from the CLC109's excellent performance on reduced or single supply voltages.

Constructed using an advanced, complementary bipolar process and Comlinear's proven high-performance architectures, the CLC109 is available in several versions to meet a variety of requirements.

CLC109AJP	-40°C to +85°C	8-pin Plastic DIP
CLC109AJE	-40°C to +85°C	8-pin Plastic SOIC
CLC109ALC	-40°C to +85°C	dice
CLC109AMC	-55°C to +125°C	dice qualified to Method 5008, MIL-STD-883, Level B
CLC109AJM5	-40°C to +85°C	5-pin SOT

Contact factory for other packages and DESC SMD number.

### Features

- High small-signal bandwidth (270MHz)
- Low supply current (3.5mA @  $\pm 5V$ )
- Low output impedance ( $2.8\Omega$ )
- $350V/\mu s$  slew rate
- Single supply operation (0 to 3V supply min.)
- Evaluation boards and Spice models

### Applications

- Video switch buffers
- Test point drivers
- Low power active filters
- DC clamping buffer
- High-speed S & H circuits
- Inverting op amp input buffer

Frequency Response for  $\pm 5V$

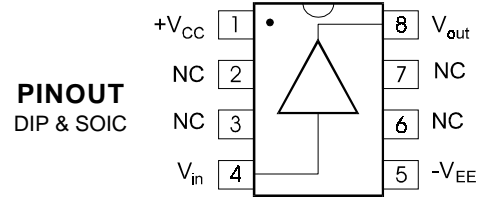
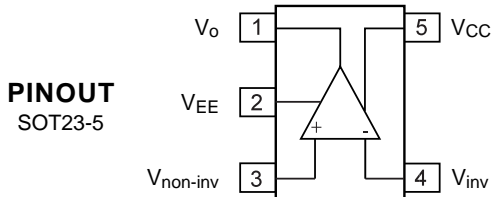
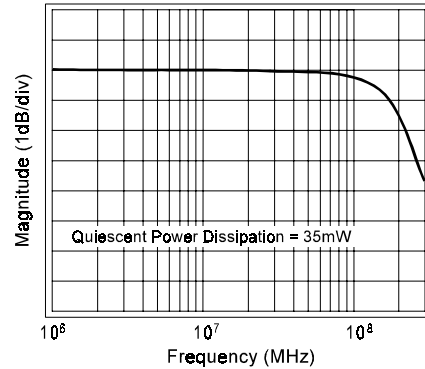

Pulse Response

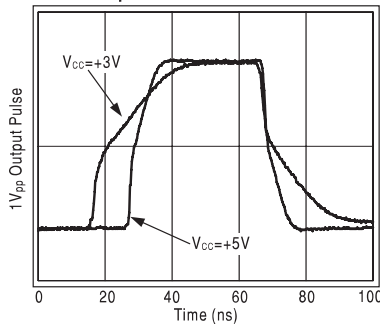

Typical Application

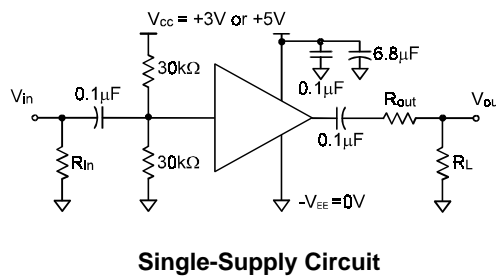

Small-Signal Bandwidth

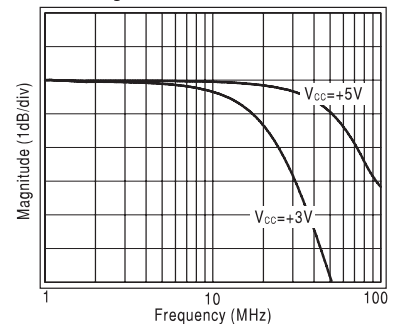

# CLC109 Electrical Characteristics ( $\pm V_{CC} = \pm 5V$ , $R_L = 100\Omega$ unless specified)

PARAMETER	CONDITIONS	TYP	MIN/MAX RATINGS			UNITS	SYMBOL
Ambient Temperature	CLC109AJ	+25°C	-40°C	+25°C	+85°C		
<b>FREQUENCY RESPONSE</b>							
small signal bandwidth	$V_{out} < 0.5V_{pp}$	270	200	200	150	MHz	SSBW
	$V_{out} < 2.0V_{pp}$	120	90	90	70	MHz	LSBW
gain flatness	$V_{out} < 0.5V_{pp}$						
flatness	DC-30MHz	0	$\pm 0.1$	$\pm 0.1$	$\pm 0.1$	dB	GFL
peaking	DC-200MHz	0	1.0	0.3	0.3	dB	GFPH
rolloff	DC-60MHz	0.1	0.4	0.4	0.6	dB	GFRH
differential gain	4.43MHz, 150 $\Omega$ load	0.7	1.5	1.0	1.0	%	DG
differential phase	4.43MHz, 150 $\Omega$ load	0.03	0.05	0.05	0.1	°	DP
<b>TIME DOMAIN RESPONSE</b>							
rise and fall time	0.5V step	1.3	1.7	1.7	2.3	ns	TRS
	2.0V step	4.4	6	6	7	ns	TRL
settling time to $\pm 0.05\%$	2.0V step	12	25	18	25	ns	TS
overshoot	0.5V step	3	15	10	10	%	OS1
slew rate	4V step	350	220	250	220	V/ $\mu$ sec	SR
<b>DISTORTION AND NOISE PERFORMANCE</b>							
2nd harmonic distortion	$2V_{pp}$ , 20MHz	-46	-36	-38	-38	dBc	HD2
3rd harmonic distortion	$2V_{pp}$ , 20MHz	-55	-50	-50	-45	dBc	HD3
equivalent output noise							
voltage		3.3	4.1	4.1	4.5	nV/ $\sqrt{\text{Hz}}$	VN
current		1.3	3	2	2	pA/ $\sqrt{\text{Hz}}$	ICN
<b>STATIC DC PERFORMANCE</b>							
small signal gain	no load	0.997	0.995	0.995	0.994	V/V	GA1
	100 $\Omega$ load	0.96	0.94	0.95	0.95	V/V	GA2
output resistance	DC	2.8	5.0	4.0	4.0	$\Omega$	RO
*output offset voltage		1	$\pm 8.2$	$\pm 5$	$\pm 6$	mV	VIO
average temperature coefficient		$\pm 10$	$\pm 40$		$\pm 30$	$\mu\text{V}/^\circ\text{C}$	DVIO
*input bias current		$\pm 2$	$\pm 8$	$\pm 4$	$\pm 4$	$\mu\text{A}$	IBN
average temperature coefficient		$\pm 30$	$\pm 50$		$\pm 25$	nA/ $^\circ\text{C}$	DIBN
power supply rejection ratio		-56	-48	-48	-46	dB	PSRR
*supply current	no load	3.5	4	4	4	mA	ICC
<b>MISCELLANEOUS PERFORMANCE</b>							
integral endpoint linearity	$\pm 1V$ , full scale	0.5	1.0	0.7	0.6	%	ILIN
input resistance		1.5	0.3	1.0	2.0	M $\Omega$	RIN
input capacitance	CERDIP	2.5	3.5	3.5	3.5	pF	CIN
	Plastic DIP	1.25	2.0	2.0	2.0	pF	CIN
output voltage range	no load	4.0	3.6	3.8	3.8	V	VO
	$R_L=100\Omega$	+3.8,-2.5	+3.0,-1.2	+3.6,-2.0	+3.6,-2.5	V	VOL
	$R_L=100\Omega$ , 0°C		+3.0,-1.6			V	VOL
output current		+60,-30	+40,-12	+40,-20	+40,-30	mA	IO
	0°C		+40,-16			mA	IO

Min/max ratings are based on product characterization and simulation. Individual parameters are tested as noted. Outgoing quality levels are determined from tested parameters.

## Absolute Maximum Ratings

$V_{CC}$	$\pm 7.0V$
$I_{out}$ output is short circuit protected to ground, but maximum reliability will be maintained if $I_{out}$ does not exceed...	30mA
input voltage	$\pm V_{CC}$
maximum junction temperature	+150°C
operating temperature range	
AJ	-40°C to +85°C
A8/AM/AL	-55°C to +125°C
storage temperature range	-65°C to +150°C
lead temperature (soldering 10 sec)	+300°C
ESD rating	1000V

## Miscellaneous Ratings

**Notes:**  
\* AJ : 100% tested at +25°C.

## Package Thermal Resistance

Package	$\theta_{JC}$	$\theta_{JA}$
Plastic (AJP)	70°C/W	125°C/W
Surface Mount (AJE)	65°C/W	145°C/W
SOT	130°C/W	200°C/W

## Reliability Information

Transistor count

17

# Electrical Characteristics ( $V_{CC}=+3V$ or $V_{CC}=+5V$ , $-V_{EE}=0V$ , $T_A=+25^\circ C$ , $R_L=100\Omega$ , unless noted)

PARAMETERS	CONDITIONS	$V_{CC}=3V$	$V_{CC}=5V$	UNITS
<b>FREQUENCY DOMAIN RESPONSE</b>				
-3dB bandwidth	$V_{out} < 0.5V_{pp}$	30	90	MHz
	$V_{out} < 2.0V_{pp}$		35	MHz
gain flatness	$V_{out} < 0.5V_{pp}$			
flatness	DC to 30MHz	3	0.3	dB
peaking	DC to 200MHz	0	0	dB
rolloff	DC to 60MHz		1.5	dB
<b>TIME DOMAIN RESPONSE</b>				
rise and fall time	0.5V step	13.9	4.7	ns
	2.0V step		13.5	ns
overshoot	0.5V step	0	0	%
slew rate	0.5V step	35	200	V/ $\mu$ s
<b>DISTORTION AND NOISE RESPONSE</b>				
2 <sup>nd</sup> harmonic distortion	0.5V <sub>pp</sub> , 20MHz	-32		dBc
	1.0V <sub>pp</sub> , 20MHz		-37	dBc
3 <sup>rd</sup> harmonic distortion	0.5V <sub>pp</sub> , 20MHz	-29		dBc
	1.0V <sub>pp</sub> , 20MHz		-43	dBc
<b>STATIC DC PERFORMANCE</b>				
small-signal gain	AC-coupled	0.89	0.94	V/V
supply current	$R_L = \infty$	0.75	1.6	mA
<b>MISCELLANEOUS PERFORMANCE</b>				
output voltage range	$R_L = \infty$	1.5	2.8	$V_{pp}$
	$R_L = 100\Omega$	1.1	2.6	$V_{pp}$

## Operation

The CLC109 is a low-power, high-speed unity-gain buffer. It uses a closed-loop topology which allows for accuracy not usually found in high-speed buffers. A closed-loop design provides high accuracy and low output impedance through a wide bandwidth.

## Single Supply Operation

Although the CLC109 is specified to operate from split  $\pm 5V$  power supplies, there is no internal ground reference that prevents operation from a single voltage power supply. For single supply operation the input signal should be biased at a DC value of  $\frac{1}{2}V_{CC}$ . This can be accomplished by AC coupling and rebiasing as shown in the "Typical Application" illustrations on the front page.

The above electrical specifications provide typical performance specifications for the CLC109 at 25°C while operating from a single +3V or a single +5V power supply.

## Printed Circuit Layout and Supply Bypassing

As with any high-frequency device, a good PCB layout is required for optimum performance. This is especially important for a device as fast as the CLC109.

To minimize capacitive feedthrough, pins 2, 3, 6, and 7 should be connected to the ground plane, as shown in Figure 1. Input and output traces should be laid out as transmission lines with the appropriate termination resistors very near the CLC109. On a 0.065 inch epoxy PCB material, a 50 $\Omega$  transmission line (commonly called stripline) can be constructed by using a trace width of 0.1" over a complete ground plane.

Figure 1 shows recommended power supply bypassing.

Parasitic or load capacitance directly on the output of the CLC109 will introduce additional phase shift in the device.

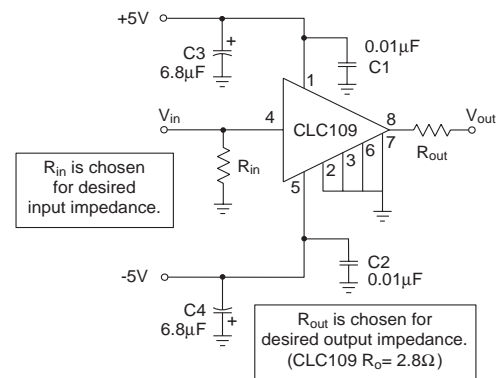

Figure 1: Recommended circuit & evaluation board schematic

This phase shift can decrease phase margin and increase frequency response peaking. A small series resistor inserted between pin 6 and the capacitance effectively decouples this effect. The graphs on the following page illustrate the required resistor value and the resulting performance vs. capacitance.

Precision buffered resistors (PRP8351 series from Precision Resistive Products), which have low parasitic reactances, were used to develop the data sheet specifications. Precision carbon composition resistors or standard spirally-trimmed RN55D metal film resistors will work, though they may cause a slight degradation of ac performance due to their reactive nature at high frequencies.

## Evaluation Boards

Evaluation boards are available from National as part CLC730012 (DIP) and CLC730045 (SOIC). This board was used in the characterization of the device and provides optimal performance. Designers are encouraged to copy these printed circuit board layouts for their applications.

# Typical Performance Characteristics ( $T_A = +25^\circ\text{C}$ , $V_{CC} = +5\text{V}$ , $R_L = 100\Omega$ unless specified)

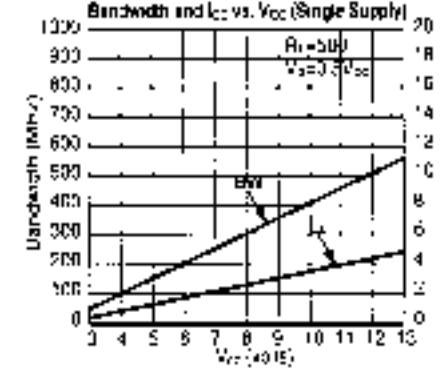
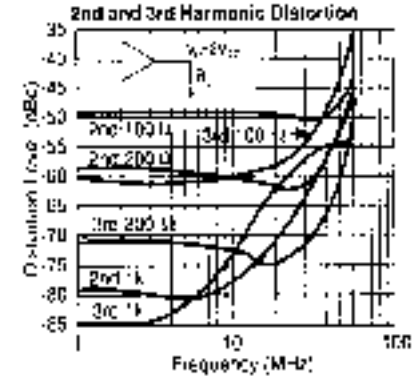
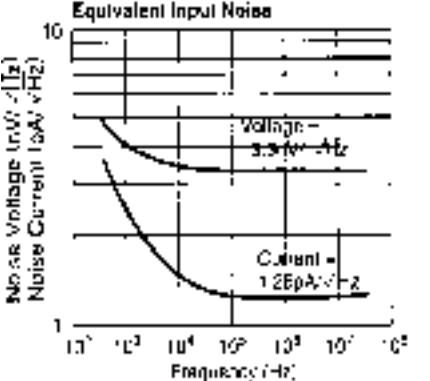
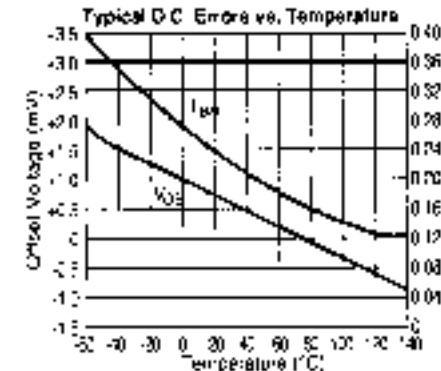
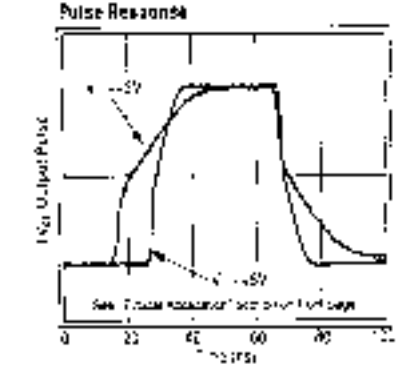
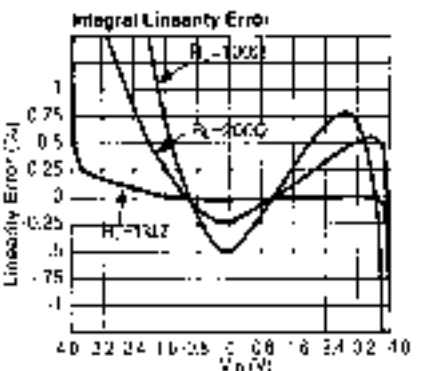
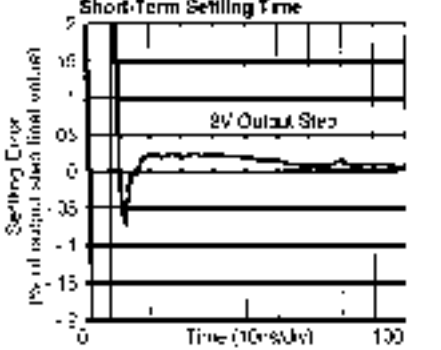
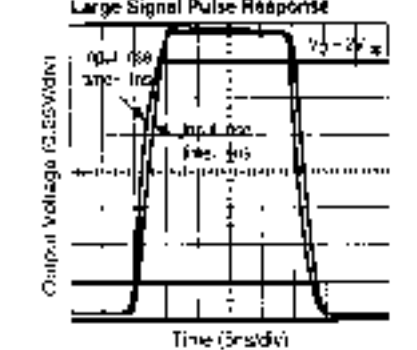
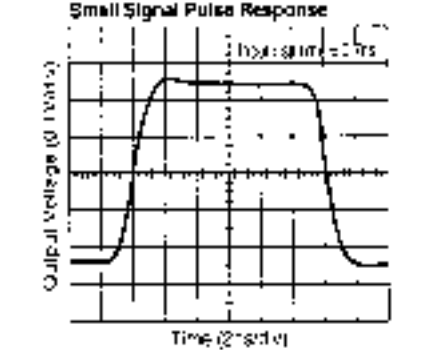
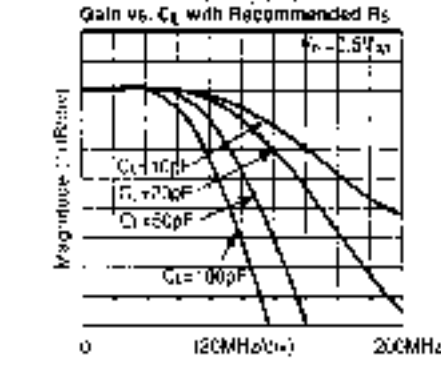
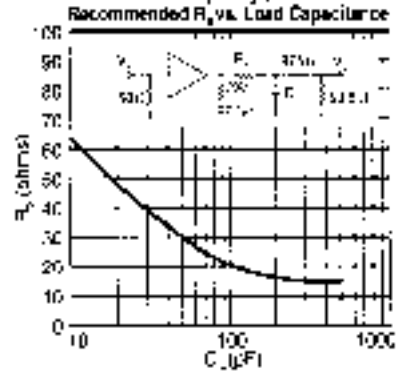
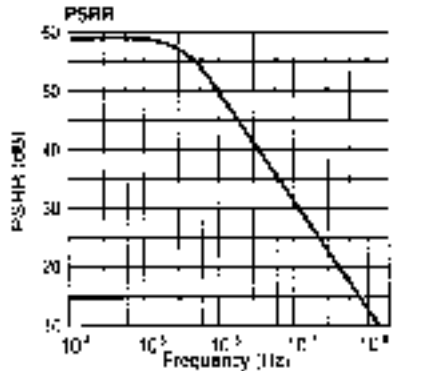
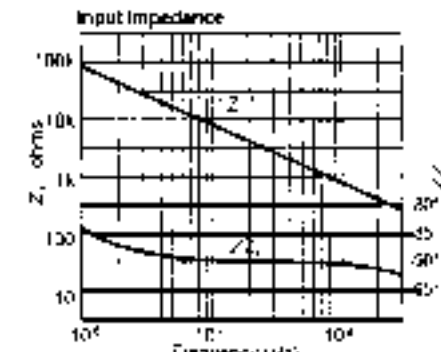
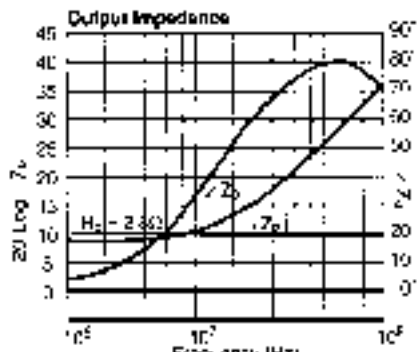
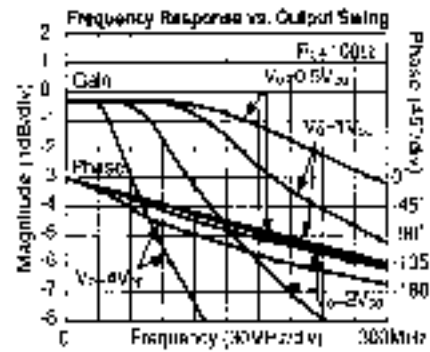

**This page intentionally left blank.**

---

### **Customer Design Applications Support**

National Semiconductor is committed to design excellence. For sales, literature and technical support, call the National Semiconductor Customer Response Group at **1-800-272-9959** or fax **1-800-737-7018**.

#### **Life Support Policy**

National's products are not authorized for use as critical components in life support devices or systems without the express written approval of the president of National Semiconductor Corporation. As used herein:

1. Life support devices or systems are devices or systems which, a) are intended for surgical implant into the body, or b) support or sustain life, and whose failure to perform, when properly used in accordance with instructions for use provided in the labeling, can be reasonably expected to result in a significant injury to the user.
2. A critical component is any component of a life support device or system whose failure to perform can be reasonably expected to cause the failure of the life support device or system, or to affect its safety or effectiveness.



#### **National Semiconductor Corporation**

1111 West Bardin Road  
Arlington, TX 76017  
Tel: 1(800) 272-9959  
Fax: 1(800) 737-7018

#### **National Semiconductor Europe**

Fax: (+49) 0-180-530 85 86  
E-mail: europe.support.nsc.com  
Deutsch Tel: (+49) 0-180-530 85 85  
English Tel: (+49) 0-180-532 78 32  
Francais Tel: (+49) 0-180-532 93 58  
Italiano Tel: (+49) 0-180-534 16 80

#### **National Semiconductor Hong Kong Ltd.**

13th Floor, Straight Block  
Ocean Centre, 5 Canton Road  
Tsimshatsui, Kowloon  
Hong Kong  
Tel: (852) 2737-1600  
Fax: (852) 2736-9960

#### **National Semiconductor Japan Ltd.**

Tel: 81-043-299-2309  
Fax: 81-043-299-2408

---

National does not assume any responsibility for use of any circuitry described, no circuit patent licenses are implied and National reserves the right at any time without notice to change said circuitry and specifications.

This datasheet has been downloaded from:

[www.DatasheetCatalog.com](http://www.DatasheetCatalog.com)

Datasheets for electronic components.

# National Semiconductor was acquired by Texas Instruments.

[http://www.ti.com/corp/docs/investor\\_relations/pr\\_09\\_23\\_2011\\_national\\_semiconductor.html](http://www.ti.com/corp/docs/investor_relations/pr_09_23_2011_national_semiconductor.html)

This file is the datasheet for the following electronic components:

CLC109AJP - <http://www.ti.com/product/clc109ajp?HQS=TI-null-null-dscatalog-df-pf-null-wwe>

CLC109AJE - <http://www.ti.com/product/clc109aje?HQS=TI-null-null-dscatalog-df-pf-null-wwe>

CLC109AJM5 - <http://www.ti.com/product/clc109ajm5?HQS=TI-null-null-dscatalog-df-pf-null-wwe>

CLC109AMC - <http://www.ti.com/product/clc109amc?HQS=TI-null-null-dscatalog-df-pf-null-wwe>

CLC109ALC - <http://www.ti.com/product/clc109alc?HQS=TI-null-null-dscatalog-df-pf-null-wwe>



LittleDiode supplies new, hard to find or obsolete electronic components and semiconductors all over the world.

With over two million different components listed you are sure to find the part you need.

Feel free to visit us today at our online store:

**[LittleDiode.com](http://LittleDiode.com)**

Looking forward to providing you with the best possible service.