

Comlinear CLC406

Wideband, Low Power Monolithic Op Amp

General Description

The CLC406 is a wideband monolithic operational amplifier designed for low-gain applications where power and cost are of primary concern. Operating from $\pm 5V$ supplies, the CLC406 consumes only 50mW of power yet maintains a 160MHz small signal bandwidth and a 1500V/ μs slew rate. Benefitting from Comlinear's current feedback architecture, the CLC406 offers a gain range of ± 1 to ± 10 while providing stable, oscillation free operation without external compensation, even at unity gain.

With its exceptional differential gain and phase, typically 0.02% and 0.02° at 3.58MHz, the CLC406 is designed to meet the performance and cost requirements of high volume composite video applications. The CLC406's large signal bandwidth, high slew rate and high drive capability are features well suited for RGB video applications.

Providing a 12ns settling time to 0.05% (1/2 LSB in 10-bit systems) and $-68/-75$ dBc 2nd/3rd harmonic distortion ($2V_{pp}$ at 10MHz, $R_L = 1k\Omega$), the CLC406 is an excellent choice as a buffer or driver for high speed A/D and D/A converter systems.

Commercial remote sensing applications and battery powered radio transceivers requiring a high performance, low power amplifier will find the CLC406 to be an attractive, cost-effective solution.

Constructed using an advanced, complementary bipolar process and Comlinear's proven current feedback architectures, the CLC406 is available in several versions to meet a variety of requirements.

CLC406AJP	-40°C to +85°C	8-pin plastic DIP
CLC406AJE	-40°C to +85°C	8-pin plastic SOIC
CLC406ALC	-40°C to +85°C	dice
CLC406AMC	-55°C to +125°C	dice qualified to Method 5008, MIL-STD-883, Level B
CLC406A8B	-55°C to +125°C	8-pin hermetic Cerdip, MIL-STD-883, Level B
CLC406A8D	-55°C to +125°C	8-pin sidebraced Cerdip, MIL-STD-883, Level B
CLC406AJM5	-40°C to +85°C	5-pin SOT

DESC SMD number: 5962-92004

Features

- 160MHz small signal bandwidth
- 50mW power ($\pm 5V$ supplies)
- 0.02%/0.02° differential gain/phase
- 12ns settling to 0.05%
- 1500V/ μs slew rate
- 2.2ns rise and fall time ($2V_{pp}$)
- 70mA output current

Applications

- Video distribution amp
- HDTV amplifier
- Flash A/D driver
- D/A transimpedance buffer
- Pulse amplifier
- Photodiode amp
- LAN amplifier

Small Signal Pulse Response

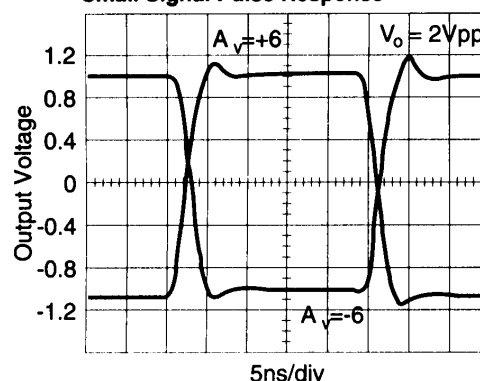

Pinout
SOT23-5

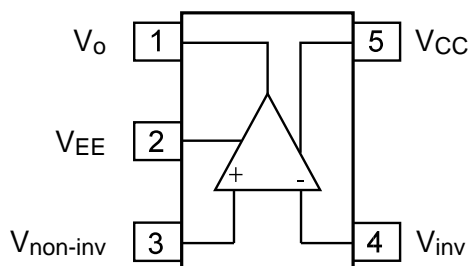

Pinout
DIP & SOIC

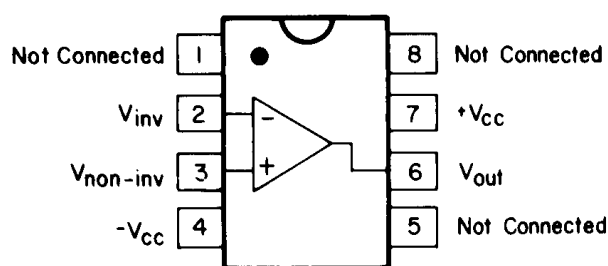

CLC406 Electrical Characteristics ($A_v = +6$, $V_{cc} = \pm 5V$, $R_L = 100\Omega$, $R_f = 500\Omega$; unless specified)

PARAMETERS	CONDITIONS	TYP	MAX & MIN RATINGS			UNITS	SYMBOL
			-40°C	+25°C	+85°C		
Ambient Temperature	CLC406AJ/AI	+25°C	-40°C	+25°C	+85°C		
Ambient Temperature	CLC406A8/AL/AM	+25°C	-55°C	+25°C	+125°C		
FREQUENCY DOMAIN PERFORMANCE							
† -3db bandwidth ¹	$V_{out} < 2V_{pp}$	160	>110	>110	>90	MHz	SSBW
	$V_{out} < 5V_{pp}$	130	>95	>95	>80	MHz	LSBW
gain flatness ²	$V_{out} < 2V_{pp}$						
† peaking	DC to 25MHz	0	<0.2	<0.2	<0.2	dB	GFPL
† peaking	>25MHz	0	<0.5	<0.5	<0.5	dB	GFPH
† rolloff	DC to 50MHz	0	<0.6	<0.6	<1.0	dB	GFR
linear phase deviation	DC to 75MHz	0.2	<0.8	<0.8	<1.2	°	LPD
differential gain	($A_v = +2$) 150Ω load, 3.58MHz	0.02	<0.04	<0.04	<0.04	%	DG1
	4.43MHz	0.02	<0.04	<0.04	<0.04	%	DG2
differential phase	($A_v = +2$) 150Ω load, 3.58MHz	0.02	<0.04	<0.04	<0.08	°	DP1
	4.43MHz	0.025	<0.05	<0.05	<0.10	°	DP2
TIME DOMAIN RESPONSE							
rise and fall time	2V step	2.2	<3.0	<3.0	<3.9	ns	TRS
	4V step	3.0	<3.6	<3.6	<5.0	ns	TRL
settling time to 0.05%	2V step	12	<18	<18	<20	ns	TS
overshoot	2V step	8	<15	<15	<15	%	OS
slew rate		1500	>1200	>1200	>1000	V/μs	SR
DISTORTION AND NOISE RESPONSE							
2nd harmonic distortion	† $2V_{pp}$, 20MHz, $R_L = 100\Omega$	-46	<-42	<-42	<-38	dBc	HD2
	$2V_{pp}$, 10MHz, $R_L = 1k\Omega$	-68	<-62	<-62	<-60	dBc	HD2L
3rd harmonic distortion	† $2V_{pp}$, 20MHz, $R_L = 100\Omega$	-50	<-46	<-46	<-42	dBc	HD3
	$2V_{pp}$, 10MHz, $R_L = 1k\Omega$	-75	<-70	<-70	<-65	dBc	HD3L
equivalent input noise							
non-inverting voltage	>1MHz	2.7	3.4	3.4	3.8	nV/√Hz	VN
inverting current	>1MHz	11.0	13.9	13.9	15.5	pA/√Hz	ICN
non-inverting current	>1MHz	2.1	2.6	2.6	3.0	pA/√Hz	NCN
total noise floor	>1MHz	-157	<-156	<-156	-155	dBm _{1Hz}	SNF
total integrated noise	1MHz to 100MHz	31	<38	<38	<42	μV	INV
STATIC, DC PERFORMANCE							
*input offset voltage		2	<10	<6	<12	mV	VIO
average temperature coefficient		30	<60	—	<60	μV/°C	DVIO
*input bias current	non-inverting	5	<24	<12	<12	μA	IBN
average temperature coefficient		30	<125	—	<50	nA/°C	DIBN
*input bias current	inverting	3	<23	<15	<20	μA	IBI
average temperature coefficient		20	<100	—	<50	nA/°C	DIBI
†power supply rejection ratio		50	>46	>46	>44	dB	PSRR
common mode rejection ratio		50	>45	>45	>43	dB	CMRR
*supply current	no load	5.0	<7.0	<6.7	<6.7	mA	ICC
MISCELLANEOUS PERFORMANCE							
non-inverting input resistance		1000	>300	>500	>500	kΩ	RIN
non-inverting input capacitance		1.0	<2.0	<2.0	<2.0	pF	CIN
output impedance	DC	0.2	<0.6	<0.3	<0.2	Ω	RO
output voltage range	$R_L = 100\Omega$	+3.1, -2.7	+1.6, -2.5	±2.7	±2.7	V	VO
common mode input range		±2.2	±1.4	±2.0	±2.0	V	CMIR
output current		70	30	50	50	mA	IO

Min/max ratings are based on product characterization and simulation. Individual parameters are tested as noted. Outgoing quality levels are determined from tested parameters.

Absolute Maximum Ratings

Miscellaneous Ratings

V_{cc}	±7V
I_{out}	output is short circuit protected to ground, but maximum reliability will be maintained if I_{out} does not exceed... 70mA
common mode input voltage	± V_{cc}
differential input voltage	10V
junction temperature	+175°C
operating temperature range	
AI/AJ:	-40°C to +85°C
A8/AM/AL	-55°C to +125°C
storage temperature range	-65°C to +150°C
Lead solder duration (+300°C)	10 sec

recommended gain range:	±1 to ±10
NOTES:	
* AI, AJ	100% tested at +25°C, sample at +85°C.
† AJ	Sample tested at +25°C.
† AI	100% tested at +25°C.
* A8	100% tested at +25°C, -55°C, +125°C.
† A8	100% tested at +25°C, sample -55°C, +125°C.
* AL, AM	100% wafer probe tested at +25°C to +25°C min/max specifications.
note 1:	At -55°C large signal is $3V_{pp}$
note 2:	Gain flatness tests performed from 0.1MHz

CLC406 Typical Performance Characteristics ($T_A = 25^\circ$, $A_V = +6$, $V_{CC} = \pm 5V$, $R_L = 100\Omega$, $R_f = 500\Omega$)

Non-Inverting Frequency Response

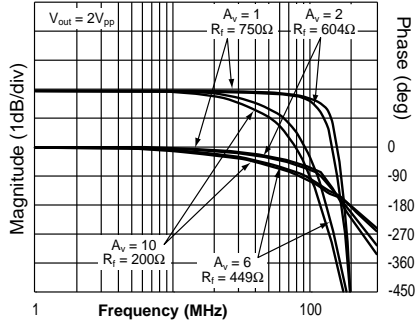

Inverting Frequency Response

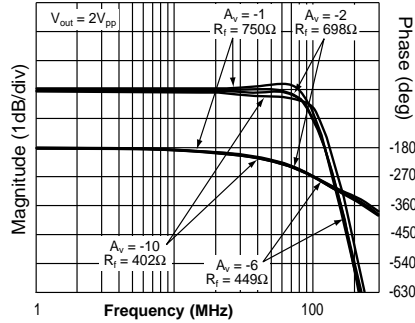

Large Signal Inverting Frequency Response

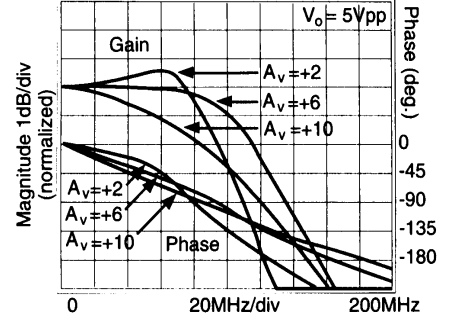

Small Signal Pulse Response

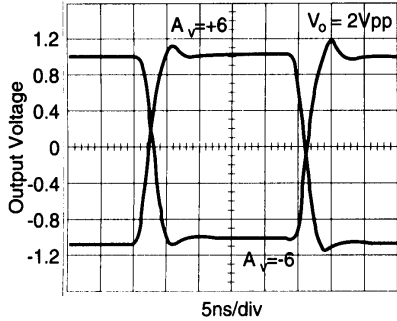

Short-Term Settling Time

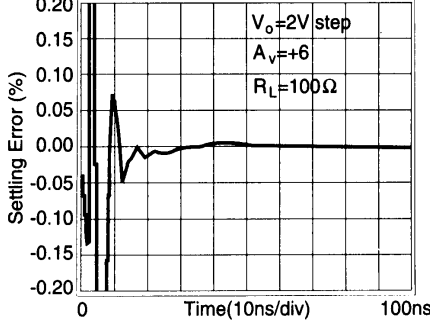

Long-Term Settling Time

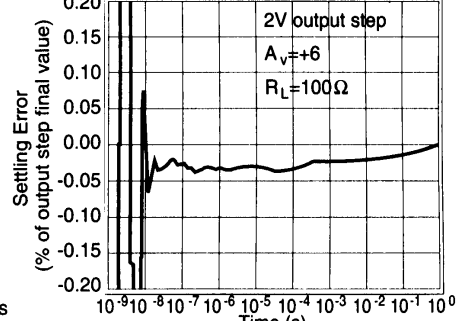

Harmonic Distortion

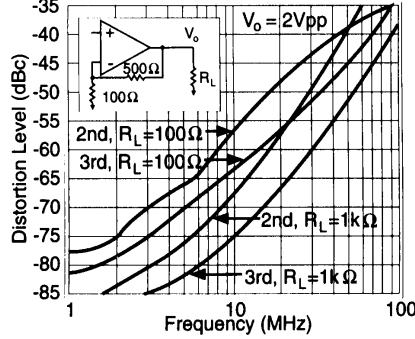

2-Tone, 3rd Order Spurious Levels

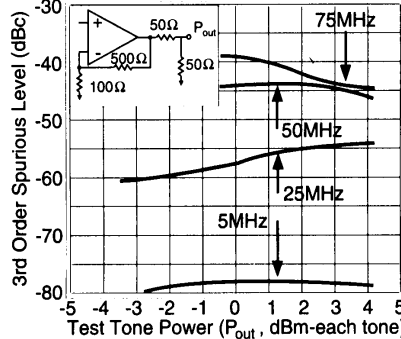

R_s and Settling Time vs. Capacitive Load

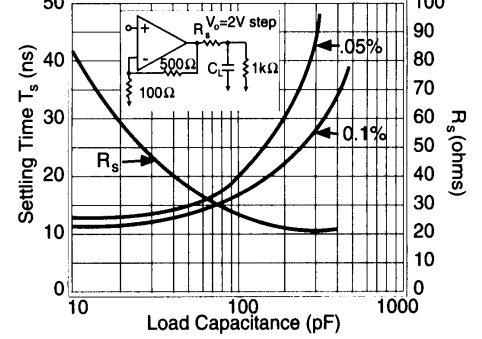

2nd Harmonic Distortion vs. Output Power

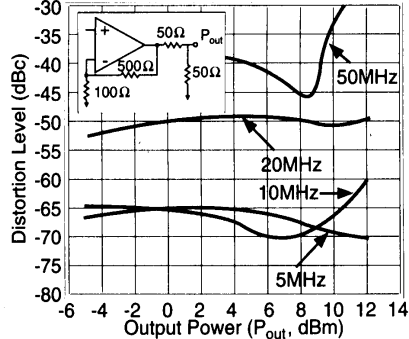

3rd Harmonic Distortion vs. Output Power

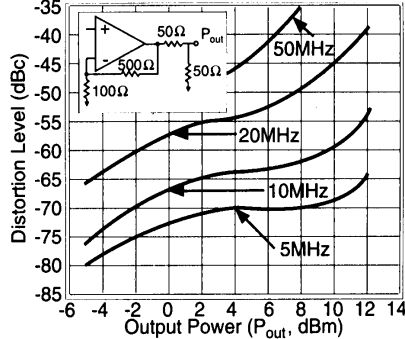

Differential Gain and Phase (4.43 MHz Video)

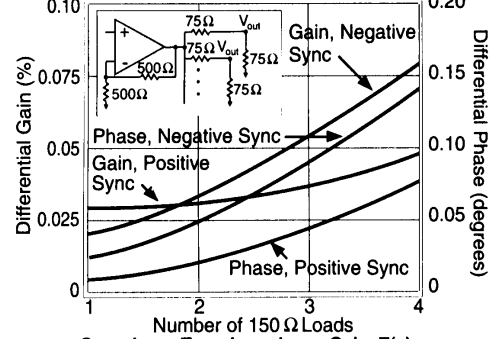

Equivalent Input Noise

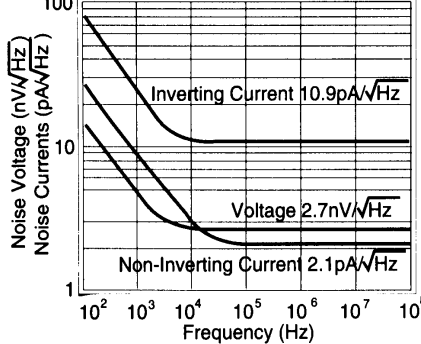

PSRR, CMRR, and Closed Loop R_o

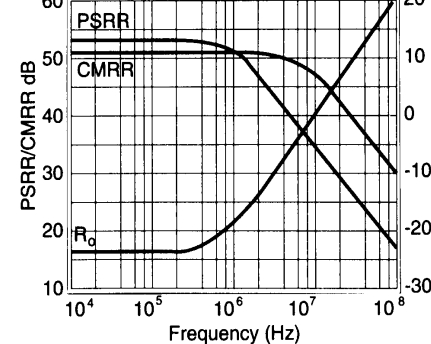

Open-Loop Transimpedance Gain, Z(s)

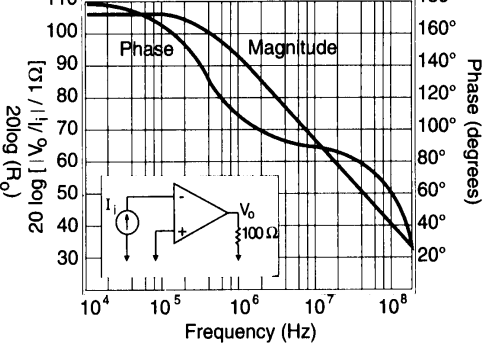
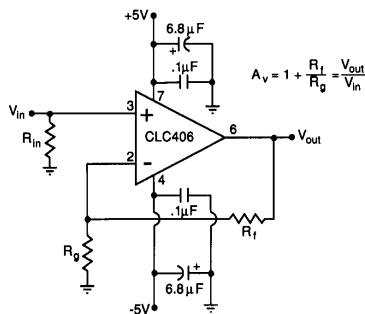

Figure 1:
recommended
non-inverting
gain circuit



Feedback Resistor

The CLC406 achieves its exceptional AC performance while requiring very low quiescent power by using the current feedback topology and an internal slew rate enhancement circuit. The loop gain and frequency response for a current feedback op amp is predominantly set by the feedback resistor value. The CLC406 is optimized for a gain of +6 to use a 500Ω feedback resistor (for maximally flat response at a gain of +2, use $R_f = 1k\Omega$). Using lower values can lead to excessive ringing in the pulse response while a higher value will limit the bandwidth. Application Note OA-13 provides a more detailed discussion of choosing a feedback resistor. A plot found within the CLC415 data sheet entitled "Recommended R_f vs. Gain" is also applicable to the CLC406. The values of R_f found on this plot will optimize the performance of the CLC406 over its ± 1 to ± 10 gain range. The CLC406, like all current feedback op amps, can be operated at higher than recommended gains with an expected reduction in bandwidth.

Slew Rate and Harmonic Distortion

The current feedback topology yields an inherently high slew rate amplifier. For this reason the CLC406 shows little difference in bandwidth between $2V_{pp}$ and $5V_{pp}$ outputs. The dominant slew rate limiting mechanism is the unity gain buffer used internally from the non-inverting to the inverting inputs. Using a slew enhancement circuit to sense the onset of slew limiting, the buffer stage momentarily increases the quiescent current to handle high slew requirements. Slew rates will decrease when operating the CLC406 at lower non-inverting gains due to the increasing signal swing through the buffer stage which is necessary to maintain a fixed desired output swing. Conversely, slew rates are generally higher and relatively insensitive to gain setting for inverting gain operation. An additional discussion of slew rates can be found in the CLC404 data sheet.

As the output signal swing is increased, the slew enhancement circuit found in the buffer stage acts to suppress harmonic distortions. This is one reason the CLC406 does not exhibit a simple relationship between output power and distortion. For example, the 2-tone, 3rd order spurious plot shows the spurious level to remain nearly constant over test tone power. For this reason the CLC406 does not exhibit an intercept type performance where the relative spurious levels change at twice the rate of the test tone power.

Differential Gain and Phase

Differential gain and phase performance specifications are common to composite video distribution applications. These specifications refer to the change in small signal gain and phase of the color subcarrier frequency (4.43MHz for PAL composite video) as the amplifier output is swept over a range of DC voltages. For this test only, the CLC406 is specified at a gain of +2 while connected to one or more doubly terminated 75Ω loads. Application Note OA-

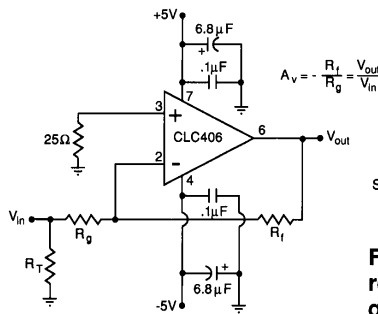

Select R_T to yield desired $R_{in} = R_T \parallel R_g$

Figure 2:
recommended inverting
gain circuit

08 provides an additional discussion of differential gain and phase measurements.

Non-inverting Source Impedance

For best operation, the DC source impedance looking out of the non-inverting input should be less than 3kΩ but greater than 20Ω. Parasitic self oscillations may occur in the input transistors if the DC source impedance is out of this range. This impedance also acts as the gain for the non-inverting input bias and noise currents and therefore can become troublesome for high values of DC source impedance. The inverting configuration of Figure 2 shows a 25Ω resistor to ground on the non-inverting input which insures stability but does not provide bias current cancellation. The input bias currents are unrelated for a current feedback amplifier which eliminates the need for source impedance matching to achieve bias current cancellation.

DC Accuracy and Noise

Figure 3 shows an example of the output offset voltage computation. The calculation is developed using typical bias current and offset voltage specifications at 25°C, a gain (A_v) of +6 and a non-inverting source impedance (R_s) of 25Ω.

Figure 3: Output Offset Voltage Calculation

$$\text{Output Offset Voltage } V_o = (\pm I_{bn}R_{in} \pm V_{io})(1 + R_f/R_g) \pm I_{bi}R_f$$

$$V_o = (\pm 5\mu A(25\Omega) \pm 2mV)(6) \pm 3\mu A(500\Omega) = \pm 14.25mV$$

Improved output offset voltage is possible using the composite circuits shown in Application Note OA-07.

The total output spot noise is computed in a similar fashion to the output offset voltage. Using the input spot noise voltage and the two input spot noise currents, the total output spot noise is developed through the same gain equations for each term but combined as the square root of the sum of squared contributing elements. Application Note OA-12 provides a more detailed discussion of noise calculations for current feedback amplifiers.

Printed Circuit Layout

As with any high speed component, a careful attention to the board layout is necessary for optimum performance. Of particular importance is the careful control of parasitic capacitances on the output pin. As the output impedance plot shows, the closed loop output for the CLC406 eventually becomes inductive as the loop gain rolls off with increasing frequency. Direct capacitive loading on the output pin can quickly lead to peaking in the frequency response, overshoot in the pulse response, ringing or even sustained oscillations. The "Suggested Series R_s vs. C" plot should be used as a starting point when a capacitive load must be driven.

Evaluation boards (part number 730013 for through-hole and 730027 for SOIC) for the CLC406 are available. Further layout suggestions can be found in Application Note OA-15.

This page intentionally left blank.

Customer Design Applications Support

National Semiconductor is committed to design excellence. For sales, literature and technical support, call the National Semiconductor Customer Response Group at **1-800-272-9959** or fax **1-800-737-7018**.

Life Support Policy

National's products are not authorized for use as critical components in life support devices or systems without the express written approval of the president of National Semiconductor Corporation. As used herein:

1. Life support devices or systems are devices or systems which, a) are intended for surgical implant into the body, or b) support or sustain life, and whose failure to perform, when properly used in accordance with instructions for use provided in the labeling, can be reasonably expected to result in a significant injury to the user.
2. A critical component is any component of a life support device or system whose failure to perform can be reasonably expected to cause the failure of the life support device or system, or to affect its safety or effectiveness.



National Semiconductor Corporation

1111 West Bardin Road
Arlington, TX 76017
Tel: 1(800) 272-9959
Fax: 1(800) 737-7018

National Semiconductor Europe

Fax: (+49) 0-180-530 85 86
E-mail: europe.support.nsc.com
Deutsch Tel: (+49) 0-180-530 85 85
English Tel: (+49) 0-180-532 78 32
Francais Tel: (+49) 0-180-532 93 58
Italiano Tel: (+49) 0-180-534 16 80

National Semiconductor Hong Kong Ltd.

13th Floor, Straight Block
Ocean Centre, 5 Canton Road
Tsimshatsui, Kowloon
Hong Kong
Tel: (852) 2737-1600
Fax: (852) 2736-9960

National Semiconductor Japan Ltd.

Tel: 81-043-299-2309
Fax: 81-043-299-2408

National does not assume any responsibility for use of any circuitry described, no circuit patent licenses are implied and National reserves the right at any time without notice to change said circuitry and specifications.

National Semiconductor was acquired by Texas Instruments.

http://www.ti.com/corp/docs/investor_relations/pr_09_23_2011_national_semiconductor.html

This file is the datasheet for the following electronic components:

CLC406 - <http://www.ti.com/product/clc406?HQS=TI-null-null-dscatalog-df-pf-null-ww>



LittleDiode supplies new, hard to find or obsolete electronic components and semiconductors all over the world.

With over two million different components listed you are sure to find the part you need.

Feel free to visit us today at our online store:

LittleDiode.com

Looking forward to providing you with the best possible service.