

Dual USB Overcurrent 1.2A Switches with Independent Controls

Features

- Dual switches, each with independent over-current protection and flag indicator, for 4 USB ports
- Two active low Enable controls, one per output
- Up to 1.2A continuous current each output
- Over-current limits at 1.2A min
- 10msec min fault blanking delay on OC# outputs prevents false overcurrent alarms
- Prevents backdrive current when host powered off
- Low operating current (95µA typ.)
- Low quiescent current when disabled (<1µA max)
- Small 8-Lead SOIC package

Applications

- PC's, Notebooks, STBs

The CM3512 also prevents backdrive current flowing into the host from the connected peripheral. This can occur when V_{CC} is removed as the host powers down, and the peripheral still has normal power applied. The 5V from the peripheral can therefore be linked to the host's V_{BUS} , potentially causing backdrive current into the host and overloading the peripheral power supply.

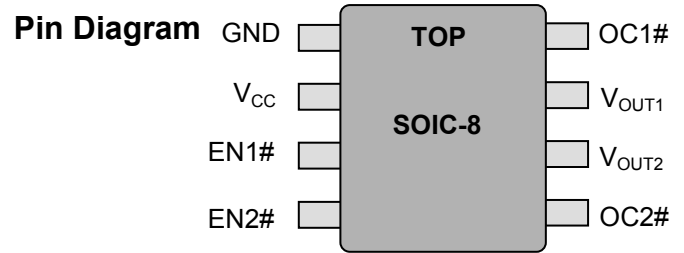

Product Description

California Micro Devices CM3512 is a dual channel USB overcurrent power switch that provides 5V power to four independent USB ports. The device has two power switches that provide the V_{BUS} voltage at each USB output port with minimal voltage drop.

When either of the EN# inputs is at logic low, the corresponding power switch is ON and V_{CC} is connected to the corresponding output through the switch. When either of the EN# inputs is at logic high, the corresponding power switch is OFF, and no power is available at the output.

Both of the power switches have full over-current protection. Whenever the current limit out of either switch is exceeded, the device enters a constant-current mode, and the output voltage is progressively reduced to prevent the current from increasing further. Each switch is independent of the other, so if a switch is on but is not in overcurrent mode then it will remain switched on. The OC# output becomes active low only if the overcurrent condition exceeds a minimum continuous duration of 10ms. This fault blanking delay prevents false alarms being reported to the host USB controller.

If the overcurrent condition is severe enough that the part heats up to the thermal limit T_{MAX} , then that switch will be turned off and the device temperature cools down. At T_{MIN} the switch then turns on again, and the device heats up again to T_{MAX} , and so on, until the fault is removed.

Typical Application Circuit

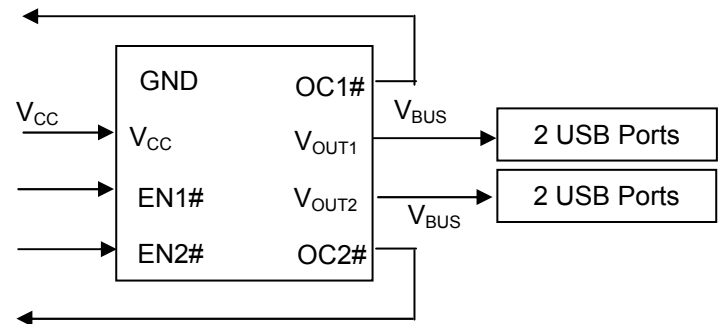

Simplified Electrical Schematic

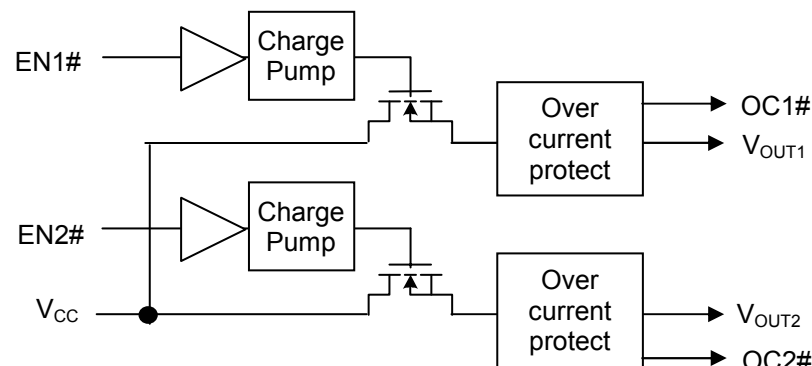



Absolute Maximum Ratings		
Parameter	Rating	Unit
ESD Protection (All pins, HBM)	± 2000	V
V _{CC} Input Voltage	+ 5.6, Gnd - 0.5	V
Storage Temperature Range	-55 to +150	°C
Operating Ambient	-40 to +85	
Operating Junction	-40 to +150*	
Output Current Loading	Internally limited	A
Package Power Dissipation	0.5	W

*Internally limited

Operating Conditions (unless specified otherwise)		
Parameter	Range	Unit
V _{CC} Input Voltage	4.5 to 5.5	V
Ambient Temperature	-40 to +85	°C
I _{LOAD} per port	0 to 1200	mA

Electrical Operating Characteristics (over operating conditions unless specified otherwise)						
Symbol	Parameter	Conditions	MIN	TYP	MAX	UNIT
UVLO	V _{CC} voltage under which circuit locks out - will not operate			2.2	2.5	V
R _{SW}	Switch ON-Resistance	I _{LOAD} = 0 to 1200mA; V _{CC} = 5V, T = 25°C		0.13	0.2	Ω
V _{OUT1} , V _{OUT2}	Output Voltage	I _{LOAD} = 1000mA, V _{CC} = 5.0V, EN# = 0V, T = 25°C	4.8			V
I _{LIM}	Over-current limit	V _{CC} = 5V, T = 25°C	1200			mA
t _{FBD}	Time delay from overcurrent detection to OC# output indication (fault blanking delay)		10	20		ms
T _{MAX}	Temperature at which hot switch turns off during overcurrent			150		°C
T _{MIN}	Temperature at which cool switch turns on, after cooling from T _{MAX}			125		°C
I _{RCC}	Reverse leakage from outputs to input	V _{CC} = 0V, V _{OUT1,2} = 5V, EN# = high, T=25°C		1		μA
I _{CC}	Operating supply current	EN# = low		95		μA
I _{CCQ}	Quiescent current	EN# = high			1	μA
V _{IH-EN}	EN# input Logic-1 threshold	V _{CC} = 5V	2			V
V _{IL-EN}	EN# input Logic-0 threshold	V _{CC} = 5V			0.8	V
I _{OHZ-OC}	OC# output OFF state leakage	V _{CC} = 5V, V _{OUT} = 5V			1.0	uA
V _{OL-OC}	OC# output Logic-0 threshold	I _{OC} = 1mA to V _{CC}			0.4	V



Pin Functions

V_{CC} is the power source.

V_{OUT1} provides the power for the first load. The internal MOSFET switches are designed for very low voltage drops from the voltage input pins at their full rated currents.

V_{OUT2} provides the power for the second load. The internal MOSFET switches are designed for very low voltage drops from the voltage input pins at their full rated currents.

Current loads of up to 1200mA are allowed. Current loads above 1200mA may cause the constant-current limiting circuit to operate, thereby reducing the output voltage.

Continuous over-current loads will cause the part's internal temperature to rise. If the internal temperature exceeds 150°C then any switch that is in overcurrent mode will be immediately turned off. Any switch that is not in overcurrent mode will remain on – it will not be affected by the over-temperature detection. Once the part has cooled to 125°C then the switch or switches that were in overcurrent mode will be automatically turned on again.

During the cold-start interval when the input is initially applied, internal circuitry provides a soft turn-on for the switch, which limits peak in-rush current.

EN1#, EN2# are the active low logic input pins that are used to control the power switches. Both switches are independent. Set EN1# and EN2# high (to >2V) to deselect V_{OUT1} and V_{OUT2} respectively, and set EN1# and EN2# low (to <0.8V) to select V_{OUT1} and V_{OUT2} respectively.

OC1#, OC2# are independent active low open-drain outputs, indicating an overcurrent fault condition has been detected at V_{OUT1} or V_{OUT2} . There is a built-in 10msec (min.) fault blanking delay after the overcurrent fault condition has been detected, before these outputs become active. The OC# outputs become inactive only when both the overcurrent condition stops and when the voltage drop across the switch is less than 1V. External pull-up resistors of 10k - 100k are required if the OC# outputs are used.

Because they are open-drain, the two OC# outputs can be shorted together to make one OC# signal.

GND is the negative reference for all voltages.

Pin Functions		
Pin No.	Symbol	Description
1	GND	Negative reference for all voltages.
2	V_{CC}	Power supply input.
3	EN1#	Active low Enable pin for V_{OUT1} .
4	EN2#	Active low Enable pin for V_{OUT2} .
5	OC2#	Active low when V_{OUT2} is in overcurrent mode.
6	V_{OUT2}	Output voltage #2.
7	V_{OUT1}	Output voltage #1.
8	OC1#	Active low when V_{OUT1} is in overcurrent mode.

STANDARD PART ORDERING INFORMATION			
Pins	Package	Ordering Part Number ¹	Part Marking
8	SOIC	CM3512-04SN	CM3512-04SN

Note 1: Parts are shipped in Tape & Reel form unless otherwise specified.



Response to Momentary Overcurrent Fault

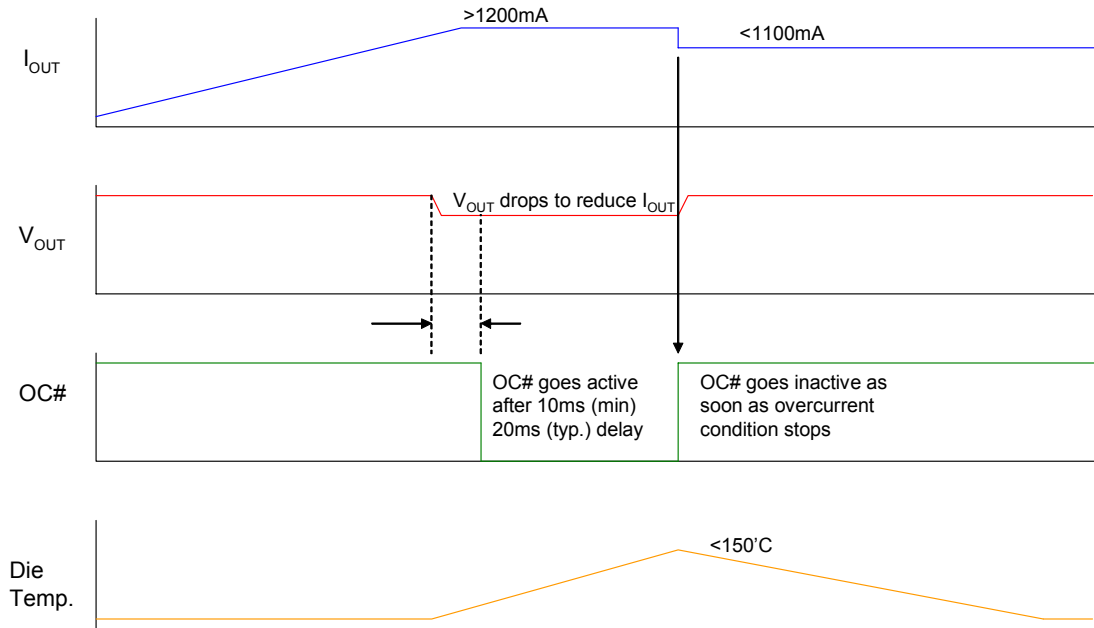

Response to Continuous Overcurrent Fault

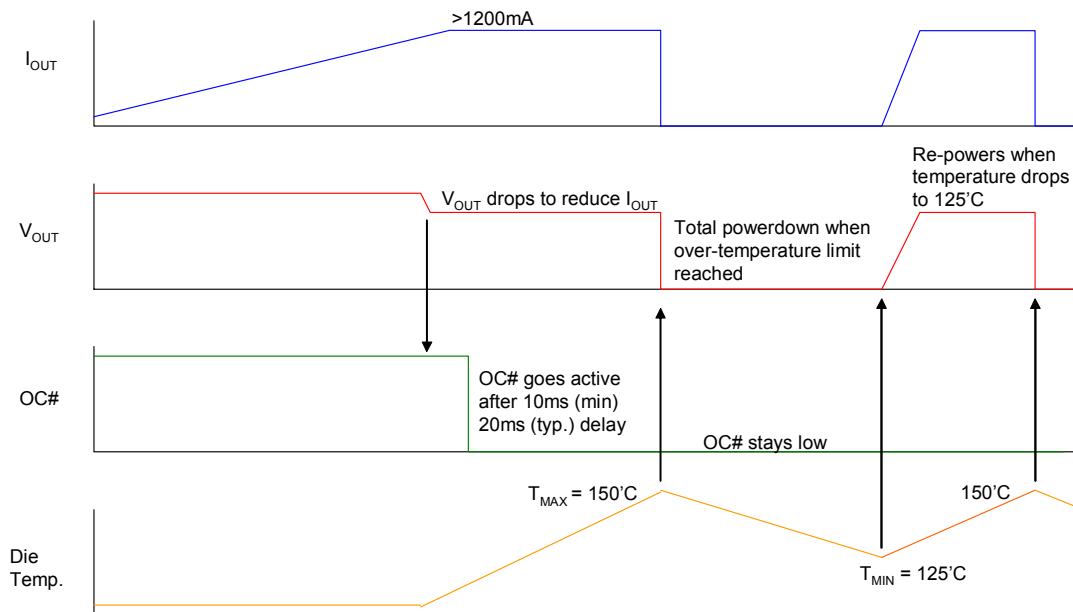

Note: The other port stays on (unless it is also in current limit.)



Typical Operating Characteristics

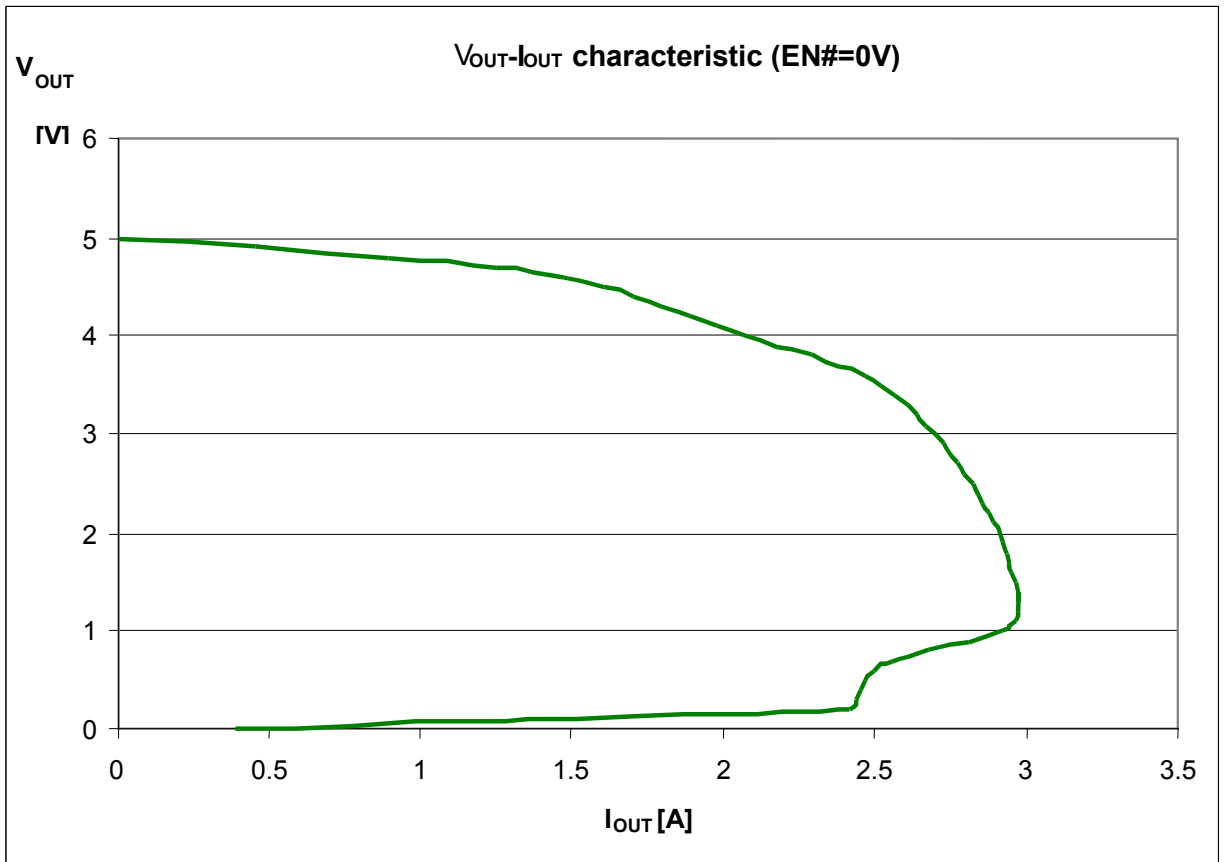
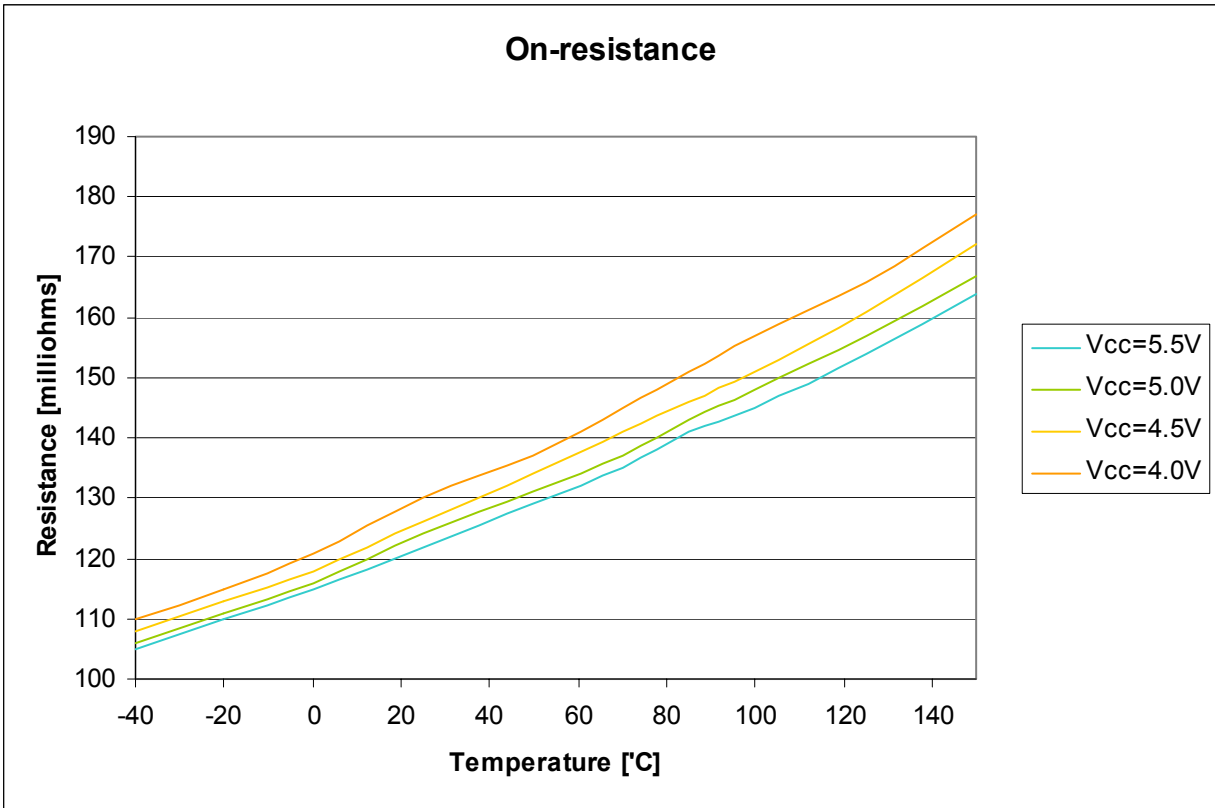

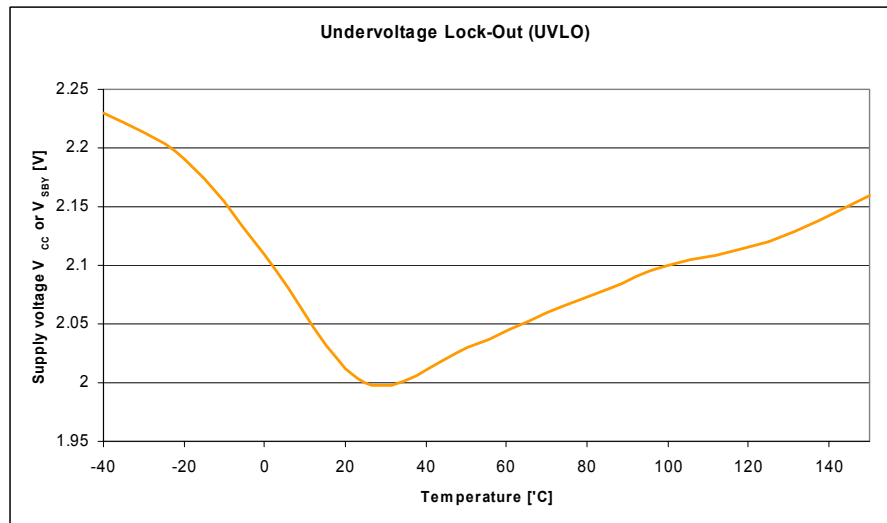
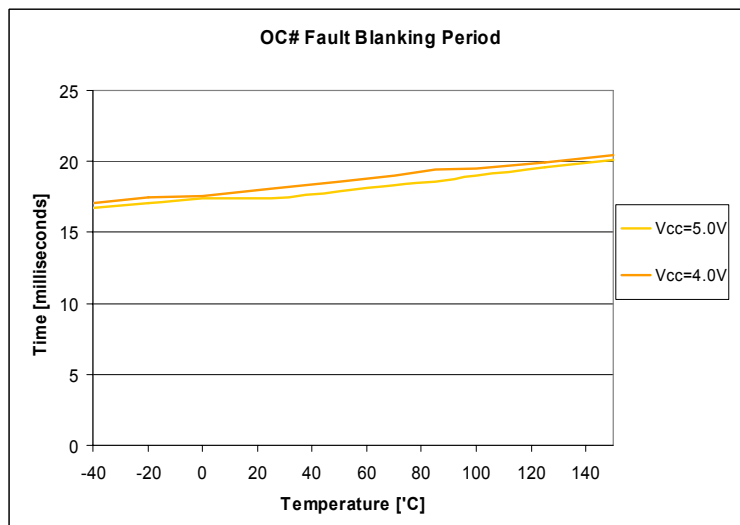
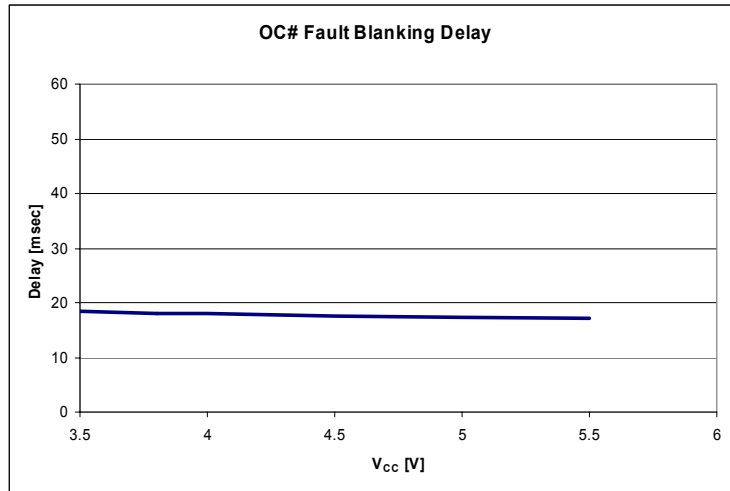

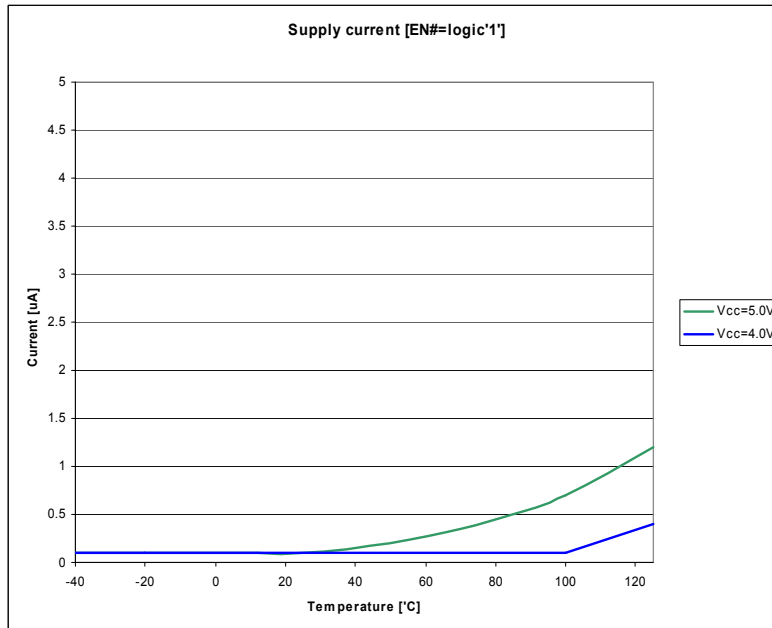
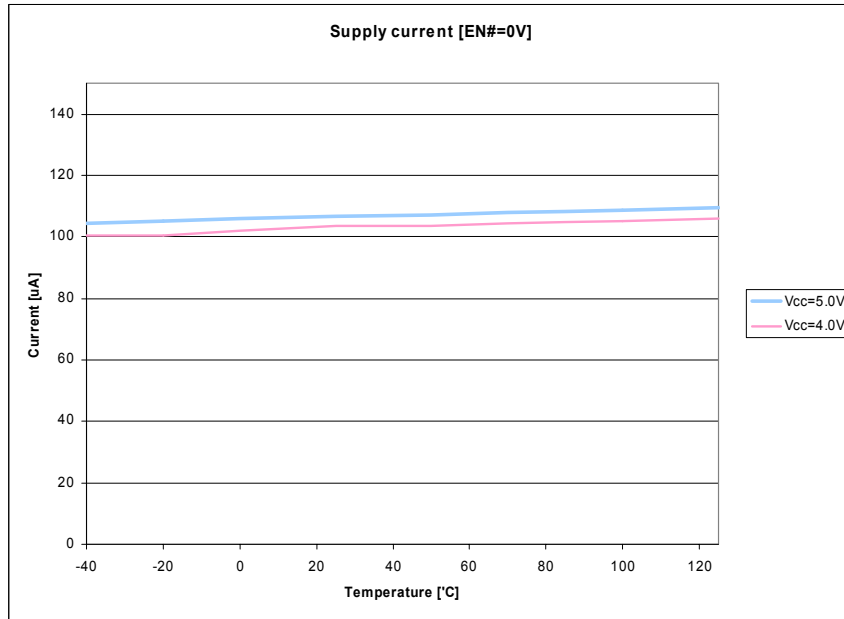
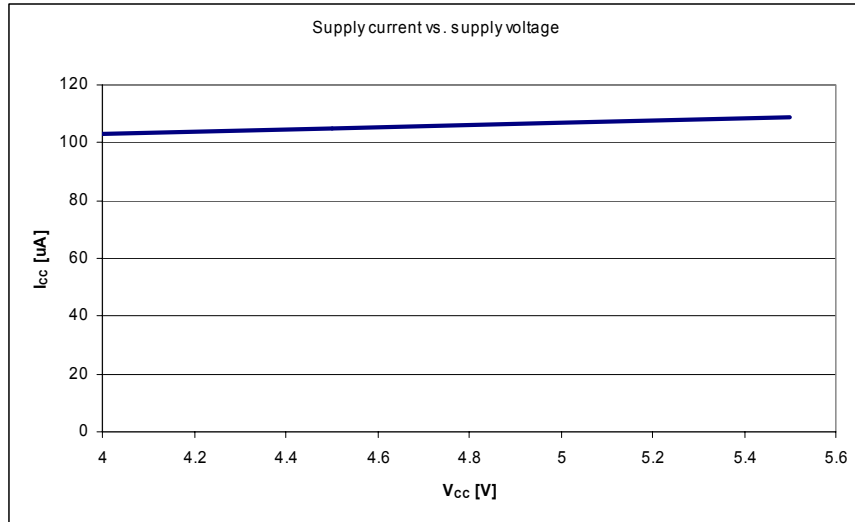

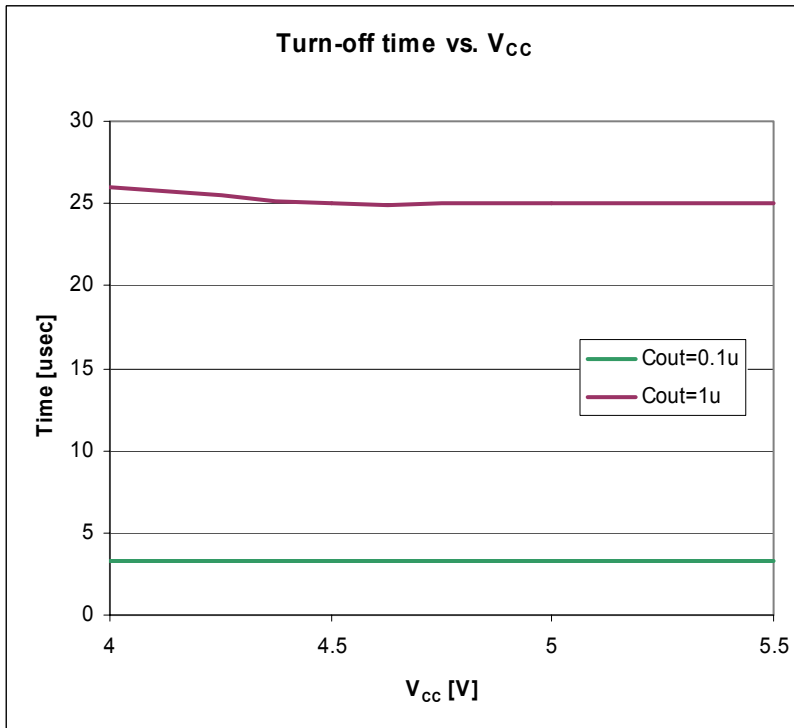
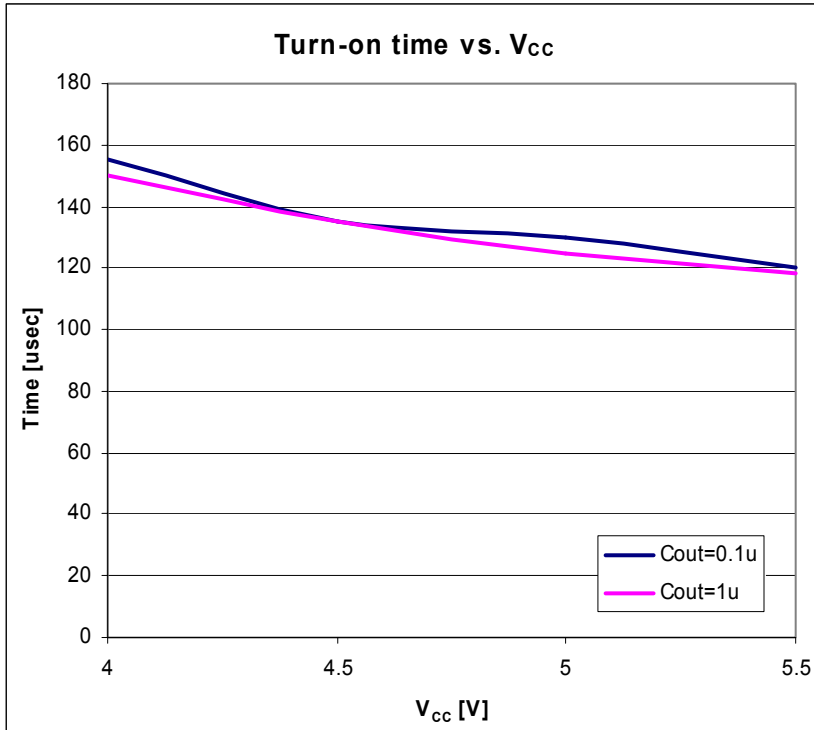

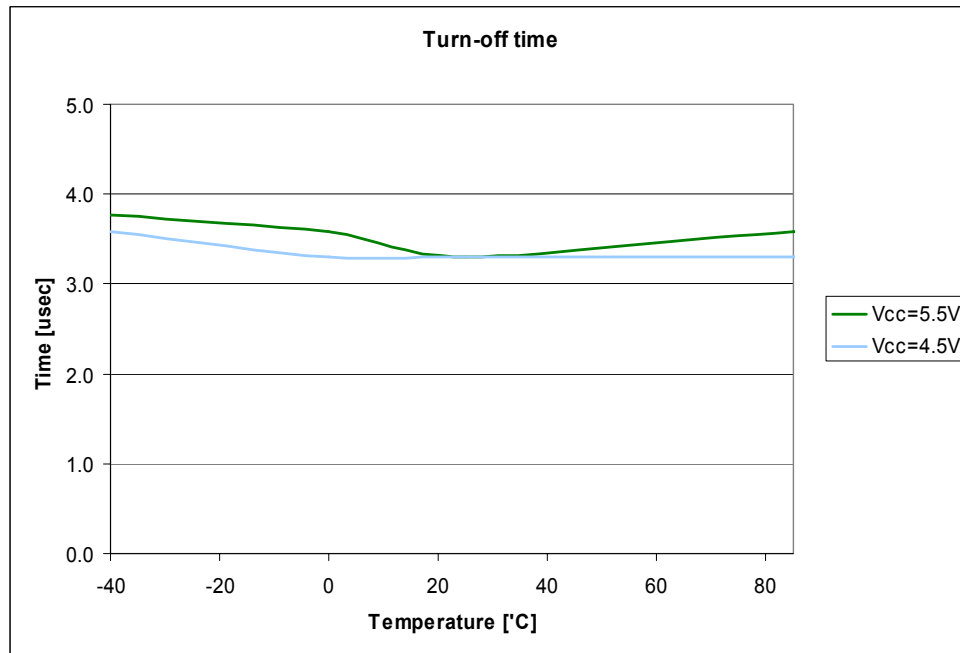
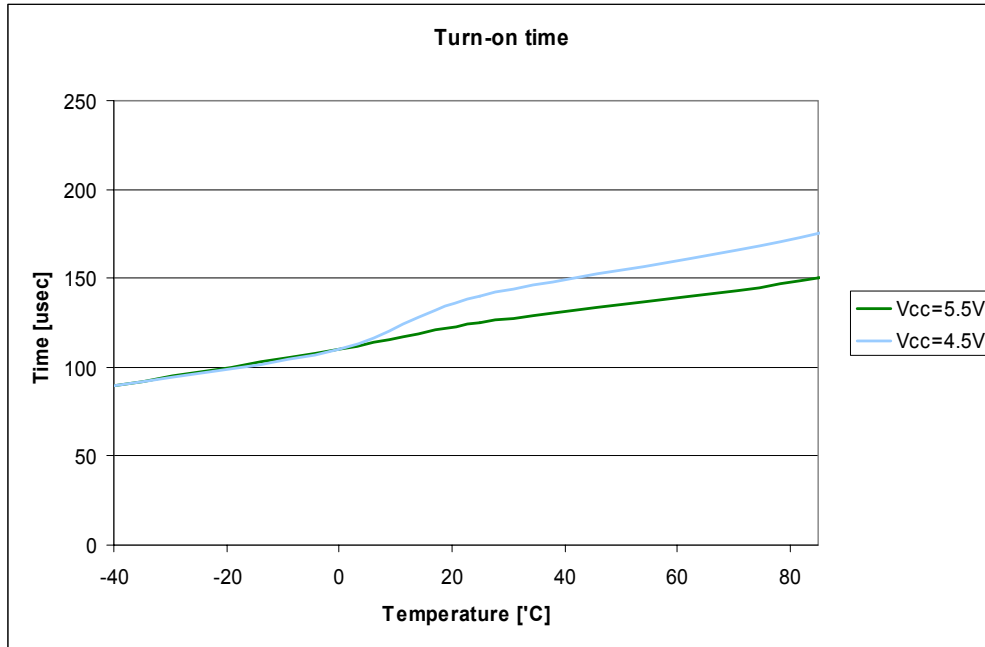

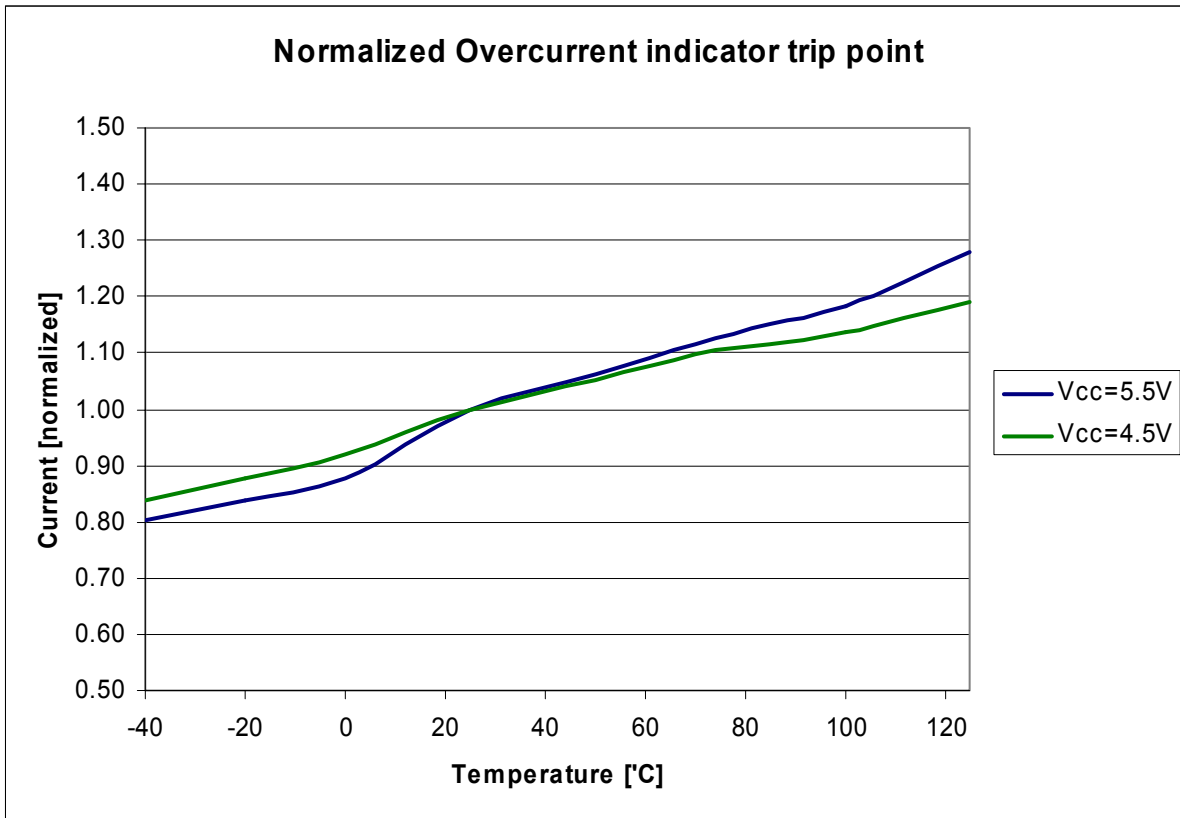



SOIC-8 Package Dimensions

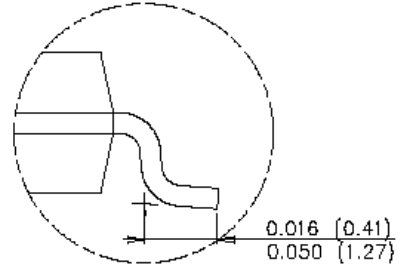
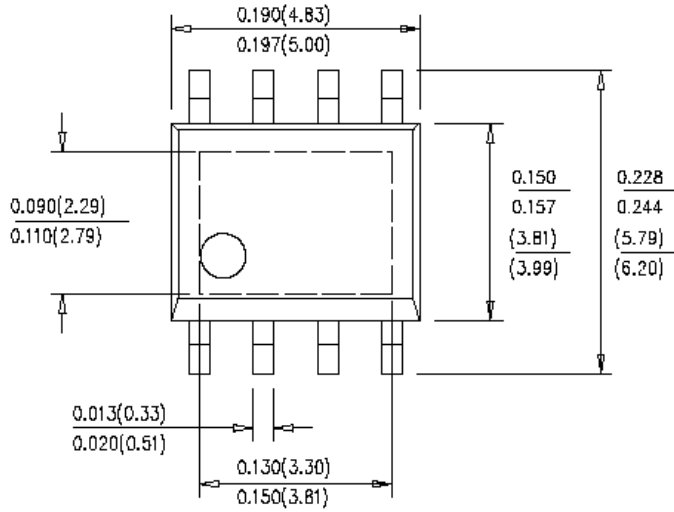

DETAIL "A"

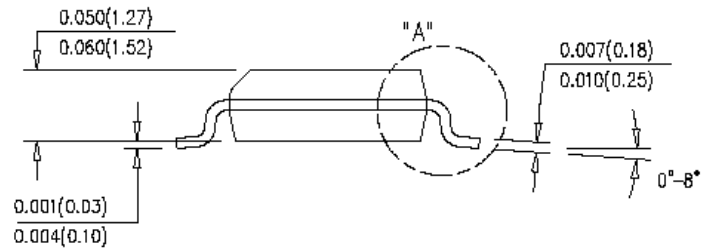
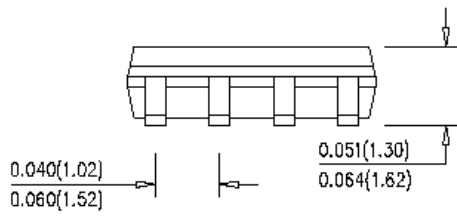



LittleDiode supplies new, hard to find or obsolete electronic components and semiconductors all over the world.

With over two million different components listed you are sure to find the part you need.

Feel free to visit us today at our online store:

LittleDiode.com

Looking forward to providing you with the best possible service.