



## BIDIRECTIONAL TRANSIL™ ARRAY FOR DATALINE PROTECTION

### MAIN APPLICATIONS

Differential data transmission lines protection, such as :

- RS-232
- RS-423
- RS-422
- RS-485

### FEATURES

- High surge capability Transil array:  
 $I_{PP} = 40 \text{ A (8/20}\mu\text{s)}$
- Peak pulse power : 300 W (8/20 $\mu\text{s}$ )
- Separated Input - Output
- Up to 9 bidirectional Transil functions
- Low clamping factor ( $V_{CL} / V_{BR}$ ) at high current level
- Low leakage current
- ESD protection up to 15kV

### DESCRIPTION

Transil diode arrays provide high overvoltage protection by clamping action. Their instantaneous response to transient overvoltages makes them particularly suited to protect voltage sensitive devices such as MOS Technology and low voltage supplied IC's.

The ITA series combines high surge capability against energetic pulses with high voltage performance against ESD.

The separated input/output configuration of the device ensures improved protection against very fast transient overvoltage like ESD by elimination of the spikes induced by parasitic inductances created by external wiring.

### COMPLIES WITH THE FOLLOWING STANDARDS:

- IEC61000-4-2 level 4:
  - 15kV (air discharge)
  - 8kV (contact discharge)
- MIL STD 883E-Method 3015-7: class3
  - 25kV HBM (Human Body Model)

TM: ASD and TRANSIL are trademarks of STMicroelectronics.

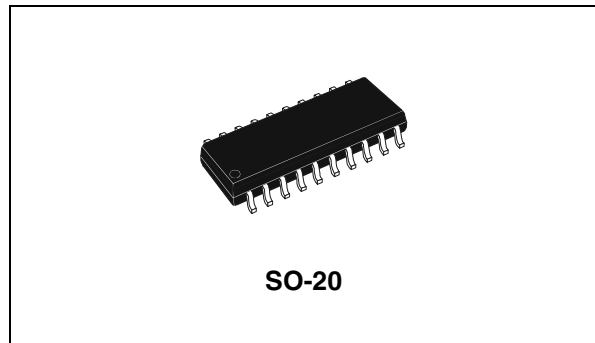
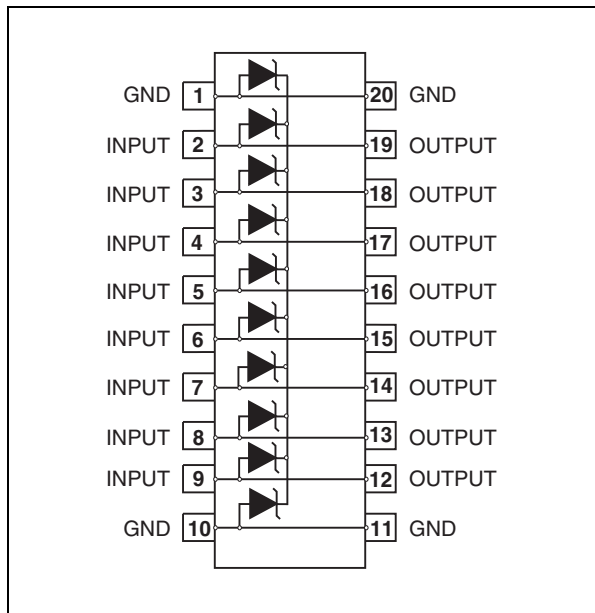

Table 1: Order Codes

Part Number	Marking
ITA6V5B3	ITA6V5B3
ITA18B3	ITA18B3
ITA18B3RL	ITA18B3
ITA25B3	ITA25B3
ITA25B3RL	ITA25B3

Figure 1: Functional Diagram



## ITAxxB3

**Table 2: Absolute Ratings** ( $T_{amb} = 25^{\circ}\text{C}$ )

Symbol	Parameter		Value	Unit
$P_{PP}$	Peak pulse power (8/20 $\mu\text{s}$ ) (see note 1)	$T_j$ initial = $T_{amb}$	300	W
$I_{PP}$	Peak pulse current (8/20 $\mu\text{s}$ ) (see note 1)	$T_j$ initial = $T_{amb}$	40	A
$I^2t$	Wire $I^2t$ value (see note 1)		0.6	$\text{A}^2\text{s}$
$T_j$	Maximum operating junction temperature		125	$^{\circ}\text{C}$
$T_{stg}$	Storage temperature range		-55 to +150	$^{\circ}\text{C}$
$T_L$	Maximum lead temperature for soldering during 10 s at 5mm for case		260	$^{\circ}\text{C}$

**Note 1:** For surges greater than the specified maximum value, the I/O will first present a short-circuit and after an open circuit caused by the wire melting.

**Table 3: Electrical Characteristics** ( $T_{amb} = 25^{\circ}\text{C}$ )

Symbol	Parameter
$V_{RM}$	Stand-off voltage
$V_{BR}$	Breakdown voltage
$V_{CL}$	Clamping voltage
$I_{RM}$	Leakage current
$I_{PP}$	Peak pulse current
$\alpha T$	Voltage temperature coefficient
$V_F$	Forward voltage drop
C	Capacitance

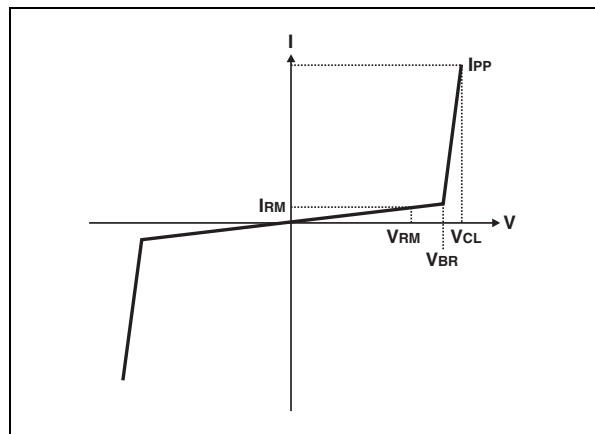

Part Number	$V_{BR}$ @ $I_R$		$I_{RM}$ @ $V_{RM}$		$V_{CL}$ @ $I_{PP}$		$V_{CL}$ @ $I_{PP}$		$\alpha T$	C
	min. note 2	mA	max. $\mu\text{A}$	V	note 2	A	note 2	A		
	V		$\mu\text{A}$	V	V	A	V	A	$10^{-4}/^{\circ}\text{C}$	pF
ITA6V5B3	6.5	1	10	5	9.5	10	121	25	4	1100
ITA18B3	18	1	4	15	21	10	26	25	9	500
ITA25B3	25	1	4	24	31	10	36	25	12	420

**Note 2:** Between I/O pin and ground.

**Note 3:** Between two input pins at 0V Bias,  $F = 1$  MHz.

Figure 2: Pulse waveform

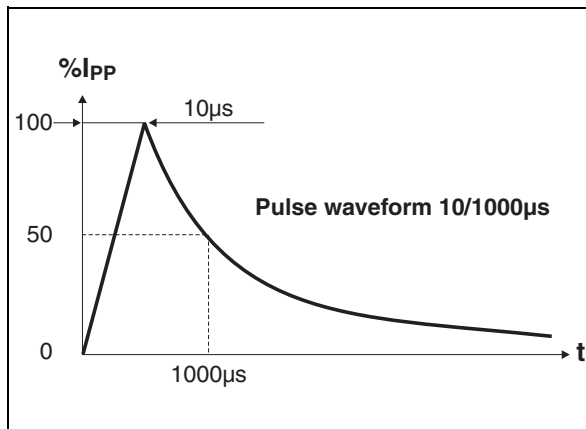

Figure 4: Clamping voltage versus peak pulse current (exponential waveform 8/20µs)

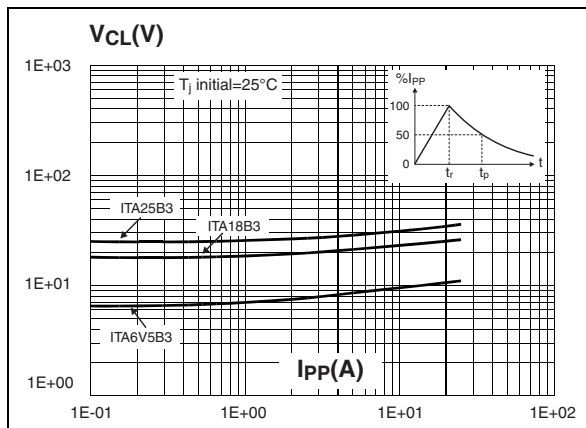

Figure 6: Junction capacitance versus reverse applied voltage for one input/output (typical values)

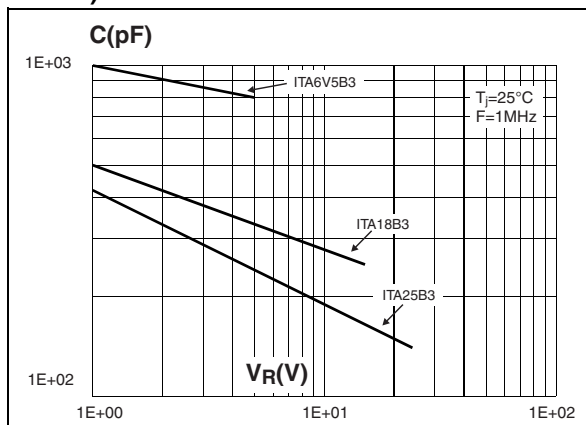

Figure 3: Typical peak power versus exponential pulse duration

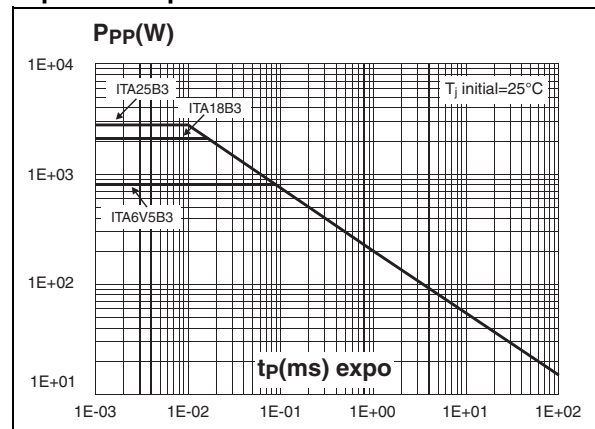

Figure 5: Peak current Idc inducing open circuit of the wire for one input/output versus pulse duration (typical values)

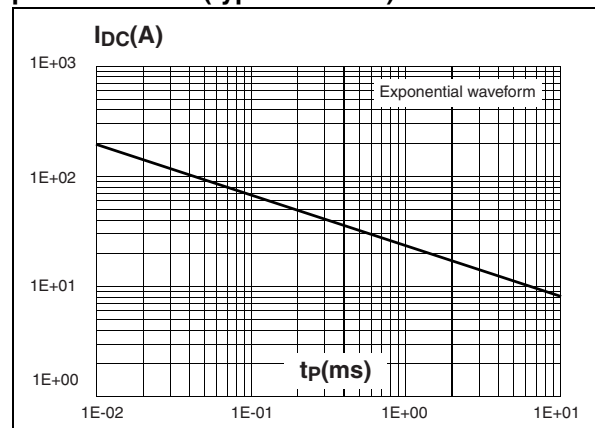
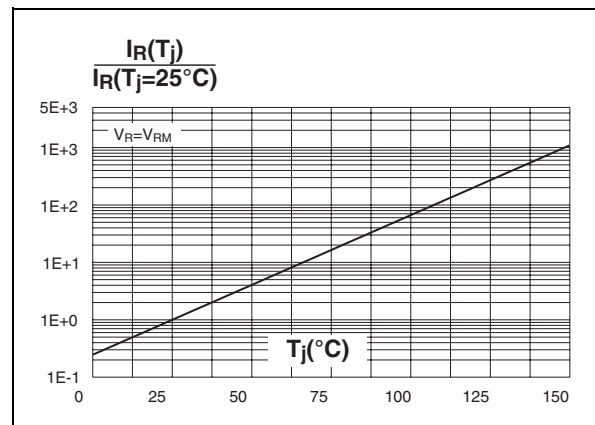

Figure 7: Relative variation of leakage current versus junction temperature



## ITAxxB3

This monolithic Transil Array is based on 610 unidirectional Transils with a common cathode and can be configured to offer up to 9 bidirectional functions. This imposes a maximum differential voltage between 2 input pins (see table 4).

**Table 4: Application information**

Types	Maximum differential voltage between two input pins at 25°C
ITA6V5B3	+ / - 3.5 v
ITA18B3	+ / - 9.0 v
ITA25B3	+ / - 12.5 v

**Figure 8: RS-232 junction (typical application)**

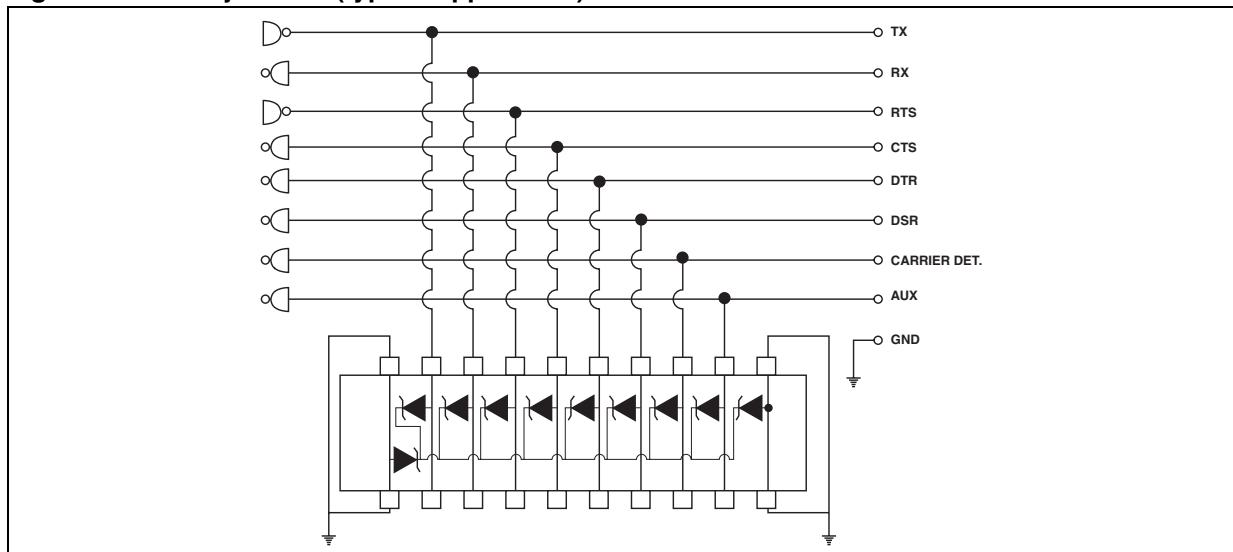

### APPLICATION NOTICE

#### Design advantage of ITAxxB3 used with 4-point structure.

The ITAxxB3 has been designed with a 4-point structure (separated Input/output) in order to efficiently protect against disturbances with very high  $di/dt$  rates, such as ESD.

The purpose of this 4-point structure is to eliminate the overvoltage introduced by the parasitic inductances of the wiring ( $Ldi/dt$ ).

Efficient protection depends not only on the component itself, but also on the circuit layout. The drawing given in figure shows the layout to be used in order to take advantage of the 4-point structure of the ITAxxB3.

**Figure 9: The 4-point structure**

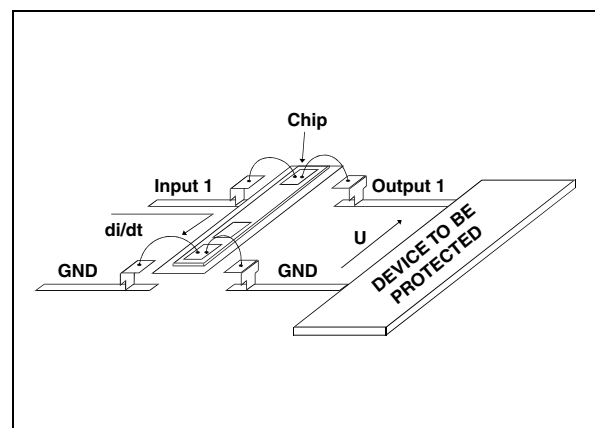

Figure 10: Ordering Information Scheme

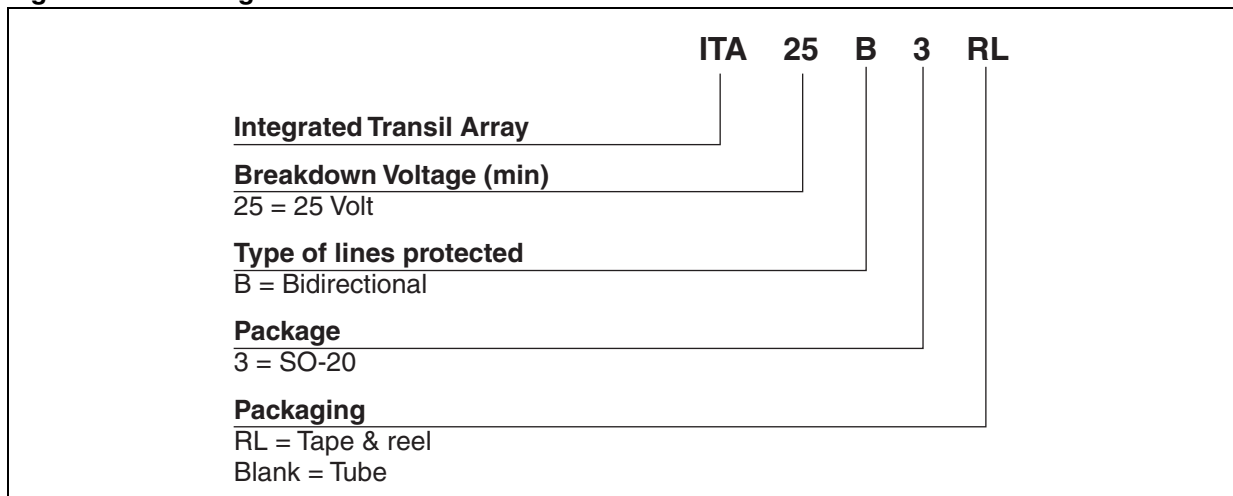

Figure 11: SO-20 Package Mechanical Data

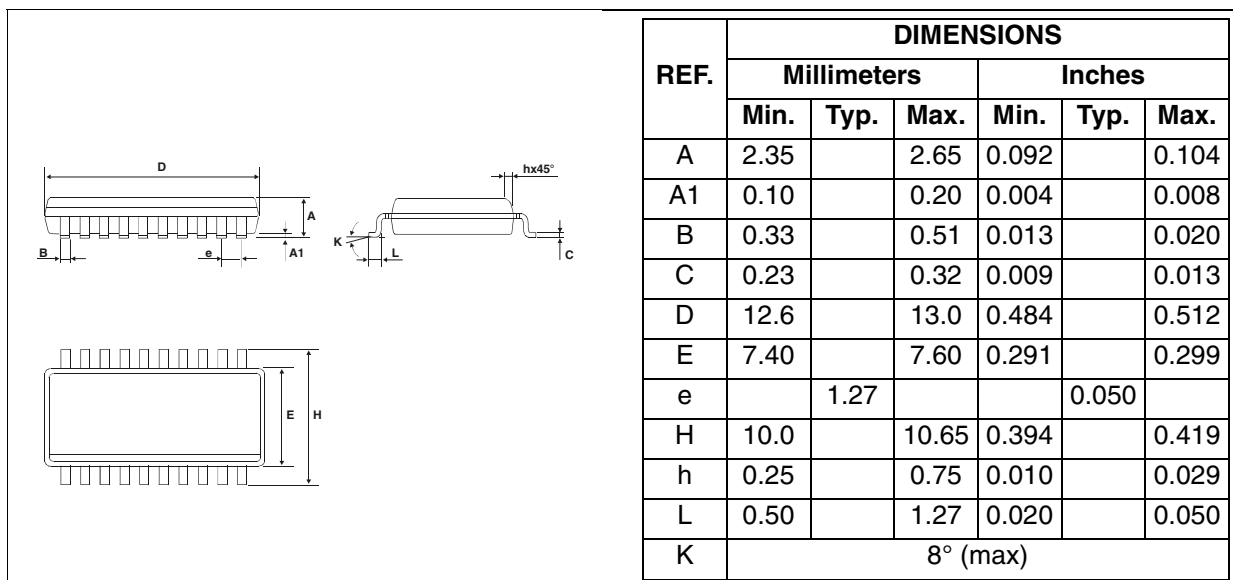
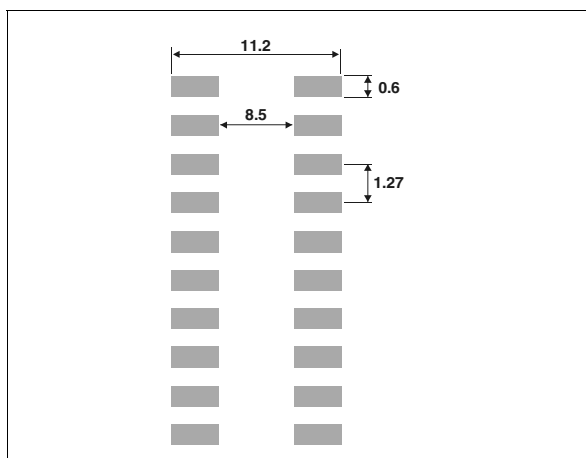

Figure 12: Foot Print Dimensions (in millimeters)



## ITAxxB3

---

**Table 5: Ordering Information**

Part Number	Marking	Package	Weight	Base qty	Delivery mode
ITA6V5B3	ITA6V5B3	SO-20	0.55 g	1000	Tube
ITA18B3	ITA18B3			1000	Tube
ITA18B3RL	ITA18B3			1000	Tape & reel
ITA25B3	ITA25B3			1000	Tube
ITA25B3RL	ITA25B3			1000	Tape & reel

**Table 6: Revision History**

Date	Revision	Description of Changes
13-Dec-2004	1	First issue.

Information furnished is believed to be accurate and reliable. However, STMicroelectronics assumes no responsibility for the consequences of use of such information nor for any infringement of patents or other rights of third parties which may result from its use. No license is granted by implication or otherwise under any patent or patent rights of STMicroelectronics. Specifications mentioned in this publication are subject to change without notice. This publication supersedes and replaces all information previously supplied. STMicroelectronics products are not authorized for use as critical components in life support devices or systems without express written approval of STMicroelectronics.

The ST logo is a registered trademark of STMicroelectronics.  
All other names are the property of their respective owners

© 2004 STMicroelectronics - All rights reserved

**STMicroelectronics group of companies**

Australia - Belgium - Brazil - Canada - China - Czech Republic - Finland - France - Germany - Hong Kong - India - Israel - Italy - Japan -  
Malaysia - Malta - Morocco - Singapore - Spain - Sweden - Switzerland - United Kingdom - United States of America  
[www.st.com](http://www.st.com)





LittleDiode supplies new, hard to find or obsolete electronic components and semiconductors all over the world.

With over two million different components listed you are sure to find the part you need.

Feel free to visit us today at our online store:

[LittleDiode.com](http://LittleDiode.com)

Looking forward to providing you with the best possible service.