

COP680C/COP681C/COP682C/COP880C/COP881C/ COP882C/COP980C/COP981C/COP982C Microcontrollers

General Description

The COP680C/COP681C/COP682C/COP880C/COP881C/COP882C/COP980C/COP981C and COP982C are members of the COPS™ microcontroller family. They are fully static parts, fabricated using double-metal silicon gate microCMOS technology. This low cost microcontroller is a complete microcomputer containing all system timing, interrupt logic, ROM, RAM, and I/O necessary to implement dedicated control functions in a variety of applications. Features include an 8-bit memory mapped architecture, MICROWIRE/PLUST™ serial I/O, a 16-bit timer/counter with capture register and a multi-sourced interrupt. Each I/O pin has software selectable options to adapt the device to the specific application. The part operates over a voltage range of 2.5 to 6.0V. High throughput is achieved with an efficient, regular instruction set operating at a 1 microsecond per instruction rate.

Key Features

- 16-bit multi-function timer supporting
 - PWM mode
 - External event counter mode
 - Input capture mode
- 4 kbytes of ROM
- 128 bytes of RAM

I/O Features

- Memory mapped I/O
- Software selectable I/O options (TRI-STATE®, Push-Pull, Weak Pull-Up Input, High Impedance Input)
- High current outputs (8 pins)

- Schmitt trigger inputs on Port G
- MICROWIRE PLUS serial I/O
- Packages:
 - 20 DIP/SO with 16 I/O pins
 - 28 DIP/SO with 24 I/O pins
 - 40 DIP, 36 I/O pins
 - 44 PLCC, 36 I/O pins

CPU/Instruction Set Features

- 1 μ s instruction cycle time
- Three multi-source interrupts servicing
 - External interrupt with selectable edge
 - Timer interrupt
 - Software interrupt
- Versatile and easy to use instruction set
- 8-bit Stack Pointer (SP)—stack in RAM
- Two 8-bit Register Indirect Data Memory Pointers (B and X)

Fully Static CMOS

- Low current drain (typically $< 1 \mu$ A)
- Single supply operation: 2.5V to 6.0V
- Temperature ranges: 0°C to 70°C, -40°C to +85°C, -55°C to +125°C.

Development Support

- Emulation and OTP devices
- Real time emulation and full program debug offered by MetaLink's development system

TRI-STATE® is a registered trademark of National Semiconductor Corporation.
COPS™, HPC™, MICROWIRE™ and MICROWIRE/PLUST™ are trademarks of National Semiconductor Corporation.
iceMASTER™ is a trademark of MetaLink Corporation.
PC-XT® and PC-AT® are registered trademarks of International Business Machines Corporation.

Block Diagram

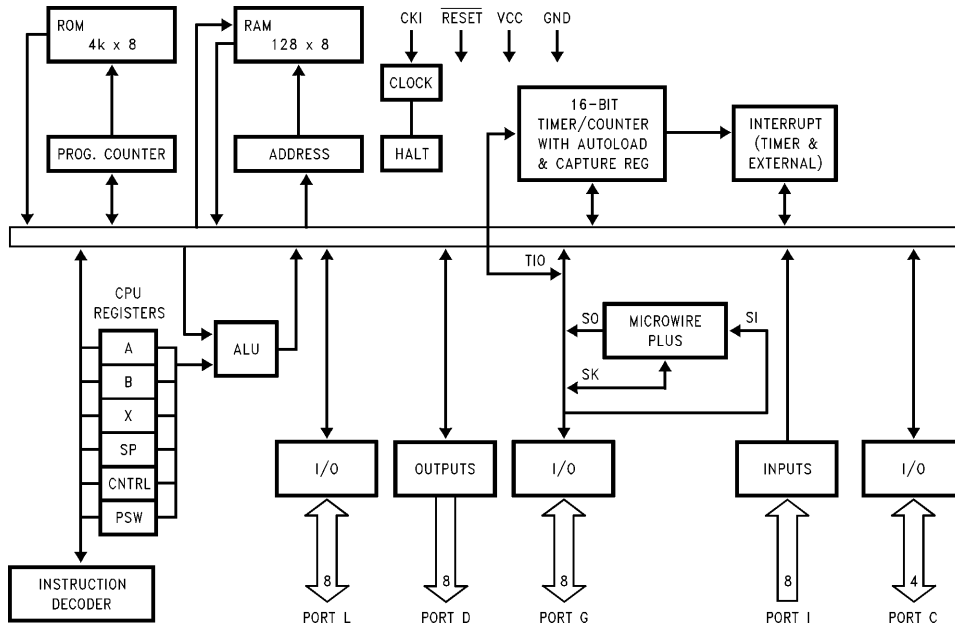
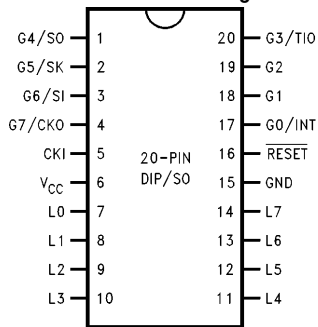

FIGURE 1

TL/DD/10802-1

Connection Diagrams

Dual-In-Line Package



TL/DD/10802-23

Top View

Order Number COP882C-XXX/N, COP982C-XXX/N,
COP882C-XXX/WM, COP982C-XXX/WM,
COP982C-XXX/N or COP982CH-XXX/WM

**Dual-In-Line Package (N)
and 28 Wide SO (WM)**

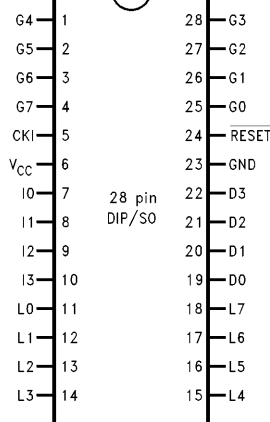

TL/DD/10802-5

Top View

Order Number COP881C-XXX/N, COP981C-XXX/N,
COP881C-XXX/WM, COP981C-XXX/WM,
COP981CH-XXX/N or COP981CH-XXX/WM

Dual-In-Line Package

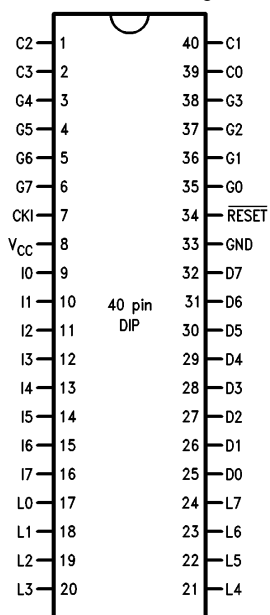

TL/DD/10802-4

Top View

Order Number COP680C-XXX/N, COP880C-XXX/N,
COP980C-XXX/N or COP980CH-XXX/N

Plastic Chip Carrier

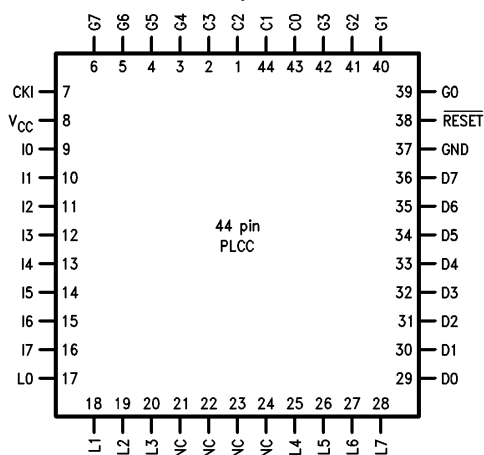

TL/DD/10802-3

Top View

Order Number COP680C-XXX/V, COP880C-XXX/V,
COP980C-XXX/V or COP980CH-XXX/V

FIGURE 3. Connection Diagrams

COP980C/COP981C/COP982C

Absolute Maximum Ratings

If Military/Aerospace specified devices are required, please contact the National Semiconductor Sales Office/Distributors for availability and specifications.

Supply Voltage (V_{CC}) 7V
 Voltage at any Pin $-0.3V$ to $V_{CC} + 0.3V$
 Total Current into V_{CC} Pin (Source) 50 mA

Total Current out of GND Pin (Sink) 60 mA
 Storage Temperature Range $-65^{\circ}C$ to $+140^{\circ}C$

Note: Absolute maximum ratings indicate limits beyond which damage to the device may occur. DC and AC electrical specifications are not ensured when operating the device at absolute maximum ratings.

DC Electrical Characteristics COP98xC; $0^{\circ}C \leq T_A \leq +70^{\circ}C$ unless otherwise specified

Parameter	Condition	Min	Typ	Max	Units
Operating Voltage 98XC 98XCH		2.3 4.0		4.0 6.0	V V
Power Supply Ripple (Note 1)	Peak to Peak			$0.1 V_{CC}$	V
Supply Current CKI = 10 MHz CKI = 4 MHz CKI = 4 MHz CKI = 1 MHz (Note 2) HALT Current (Note 3)	$V_{CC} = 6V, t_c = 1 \mu s$ $V_{CC} = 6V, t_c = 2.5 \mu s$ $V_{CC} = 4.0V, t_c = 2.5 \mu s$ $V_{CC} = 4.0V, t_c = 10 \mu s$ $V_{CC} = 6V, CKI = 0 MHz$ $V_{CC} = 4.0V, CKI = 0 MHz$			6.0 4.4 2.2 1.4 8 5	mA mA mA mA μA μA
Input Levels RESET, CKI Logic High Logic Low All Other Inputs Logic High Logic Low		$0.9 V_{CC}$ $0.7 V_{CC}$		 $0.1 V_{CC}$ $0.2 V_{CC}$	V V V V
Hi-Z Input Leakage Input Pullup Current	$V_{CC} = 6.0V$ $V_{CC} = 6.0V, V_{IN} = 0V$	-1.0 -40		+1.0 -250	μA μA
G Port Input Hysteresis				$0.35 V_{CC}$	V
Output Current Levels D Outputs Source Sink All Others Source (Weak Pull-Up) Source (Push-Pull Mode) Sink (Push-Pull Mode) TRI-STATE Leakage	$V_{CC} = 4.5V, V_{OH} = 3.8V$ $V_{CC} = 2.3V, V_{OH} = 1.6V$ $V_{CC} = 4.5V, V_{OL} = 1.0V$ $V_{CC} = 2.3V, V_{OL} = 0.4V$ $V_{CC} = 4.5V, V_{OH} = 3.2V$ $V_{CC} = 2.3V, V_{OH} = 1.6V$ $V_{CC} = 4.5V, V_{OH} = 3.8V$ $V_{CC} = 2.3V, V_{OH} = 1.6V$ $V_{CC} = 4.5V, V_{OL} = 0.4V$ $V_{CC} = 2.3V, V_{OL} = 0.4V$ $V_{CC} = 6.0V$	-0.4 -0.2 10 2 -10 -2.5 -0.4 -0.2 1.6 0.7 -1.0		 -110 -33 +1.0	mA mA mA mA μA μA mA mA μA
Allowable Sink/Source Current Per Pin D Outputs (Sink) All Others				15 3	mA mA
Maximum Input Current (Note 4) Without Latchup (Room Temp)	Room Temp			± 100	mA
RAM Retention Voltage, V_r (Note 5)	500 ns Rise and Fall Time (Min)	2.0			V
Input Capacitance				7	pF
Load Capacitance on D2				1000	pF

COP980C/COP981C/COP982C

DC Electrical Characteristics (Continued)

Note 1: Rate of voltage change must be less than 0.5V/ms.

Note 2: Supply current is measured after running 2000 cycles with a square wave CKI input, CKO open, inputs at rails and outputs open.

Note 3: The HALT mode will stop CKI from oscillating in the RC and the Crystal configurations. Test conditions: All inputs tied to V_{CC} , L, C and G ports TRI-STATE and tied to ground, all outputs low and tied to ground.

Note 4: Pins G6 and RESET are designed with a high voltage input network for factory testing. These pins allow input voltages greater than V_{CC} and the pins will have sink current to V_{CC} when biased at voltages greater than V_{CC} (the pins do not have source current when biased at a voltage below V_{CC}). The effective resistance to V_{CC} is 750 Ω (typ). These two pins will not latch up. The voltage at the pins must be limited to less than 14V.

Note 5: To maintain RAM integrity, the voltage must not be dropped or raised instantaneously.

AC Electrical Characteristics $0^{\circ}\text{C} \leq T_A \leq +70^{\circ}\text{C}$ unless otherwise specified

Parameter	Condition	Min	Typ	Max	Units
Instruction Cycle Time (t_c)					
Crystal/Resonator or External (Div-by 10)	$V_{CC} \geq 4.0\text{V}$	1		DC	μs
	$2.3\text{V} \leq V_{CC} \leq 4.0\text{V}$	2.5		DC	μs
R/C Oscillator Mode (Div-by 10)	$V_{CC} \geq 4.0\text{V}$	3		DC	μs
	$2.3\text{V} \leq V_{CC} \leq 4.0\text{V}$	7.5		DC	μs
CKI Clock Duty Cycle (Note 6)	$f_r = \text{Max}$	40		60	%
Rise Time (Note 6)	$f_r = 10\text{ MHz Ext Clock}$			12	ns
Fall Time (Note 6)	$f_r = 10\text{ MHz Ext Clock}$			8	ns
Inputs					
t_{SETUP}	$V_{CC} \geq 4.0\text{V}$	200			ns
	$2.3\text{V} \leq V_{CC} \leq 4.0\text{V}$	500			ns
t_{HOLD}	$V_{CC} \geq 4.0\text{V}$	60			ns
	$2.3\text{V} \leq V_{CC} \leq 4.0\text{V}$	150			ns
Output Propagation Delay	$C_L = 100\text{ pF}, R_L = 2.2\text{ k}\Omega$				
$t_{\text{PD1}}, t_{\text{PD0}}$ SO, SK	$V_{CC} \geq 4.0\text{V}$			0.7	μs
	$2.3\text{V} \leq V_{CC} \leq 4.0\text{V}$			1.75	μs
All Others	$V_{CC} \geq 4.0\text{V}$			1	μs
	$2.3\text{V} \leq V_{CC} \leq 4.0\text{V}$			2.5	μs
MICROWIRE™ Setup Time (t_{UWS})		20			ns
MICROWIRE Hold Time (t_{UWH})		56			ns
MICROWIRE Output Propagation Delay (t_{UPD})				220	ns
Input Pulse Width					
Interrupt Input High Time		t_C			
Interrupt Input Low Time		t_C			
Timer Input High Time		t_C			
Timer Input Low Time		t_C			
Reset Pulse Width		1.0			μs

Note 6: Parameter characterized but not production tested.

COP880C/COP881C/COP882C

Absolute Maximum Ratings

If Military/Aerospace specified devices are required, please contact the National Semiconductor Sales Office/Distributors for availability and specifications.

Supply Voltage (V_{CC}) 7V
 Voltage at any Pin $-0.3V$ to $V_{CC} + 0.3V$
 Total Current into V_{CC} Pin (Source) 50 mA

Total Current out of GND Pin (Sink) 60 mA
 Storage Temperature Range $-65^{\circ}C$ to $+140^{\circ}C$

Note: Absolute maximum ratings indicate limits beyond which damage to the device may occur. DC and AC electrical specifications are not ensured when operating the device at absolute maximum ratings.

DC Electrical Characteristics COP88xC; $-40^{\circ}C \leq T_A \leq +85^{\circ}C$ unless otherwise specified

Parameter	Condition	Min	Typ	Max	Units
Operating Voltage		2.5		6.0	V
Power Supply Ripple (Note 1)	Peak to Peak			$0.1 V_{CC}$	V
Supply Current					
CKI = 10 MHz	$V_{CC} = 6V, t_c = 1 \mu s$			6.0	mA
CKI = 4 MHz	$V_{CC} = 6V, t_c = 2.5 \mu s$			4.4	mA
CKI = 4 MHz	$V_{CC} = 4.0V, t_c = 2.5 \mu s$			2.2	mA
CKI = 1 MHz	$V_{CC} = 4.0V, t_c = 10 \mu s$			1.4	mA
(Note 2)					
HALT Current	$V_{CC} = 6V, CKI = 0$ MHz		<1	10	μA
(Note 3)	$V_{CC} = 3.5V, CKI = 0$ MHz		<0.5	6	μA
Input Levels					
RESET, CKI					
Logic High		$0.9 V_{CC}$			V
Logic Low				$0.1 V_{CC}$	V
All Other Inputs					
Logic High		$0.7 V_{CC}$			V
Logic Low				$0.2 V_{CC}$	V
Hi-Z Input Leakage	$V_{CC} = 6.0V$	-2		+2	μA
Input Pullup Current	$V_{CC} = 6.0V, V_{IN} = 0V$	-40		-250	μA
G Port Input Hysteresis				$0.35 V_{CC}$	V
Output Current Levels					
D Outputs					
Source	$V_{CC} = 4.5V, V_{OH} = 3.8V$	-0.4			mA
	$V_{CC} = 2.5V, V_{OH} = 1.8V$	-0.2			mA
Sink	$V_{CC} = 4.5V, V_{OL} = 1.0V$	10			mA
	$V_{CC} = 2.5V, V_{OL} = 0.4V$	2			mA
All Others					
Source (Weak Pull-Up)	$V_{CC} = 4.5V, V_{OH} = 3.2V$	-10		-110	μA
	$V_{CC} = 2.5V, V_{OH} = 1.8V$	-2.5		-33	μA
Source (Push-Pull Mode)	$V_{CC} = 4.5V, V_{OH} = 3.8V$	-0.4			mA
	$V_{CC} = 2.5V, V_{OH} = 1.8V$	-0.2			mA
Sink (Push-Pull Mode)	$V_{CC} = 4.5V, V_{OL} = 0.4V$	1.6			mA
	$V_{CC} = 2.5V, V_{OL} = 0.4V$	0.7			mA
TRI-STATE Leakage	$V_{CC} = 6.0V$	-2.0		+2.0	μA
Allowable Sink/Source Current Per Pin					
D Outputs (Sink)				15	mA
All Others				3	mA
Maximum Input Current (Note 4) Without Latchup (Room Temp)	Room Temp			± 100	mA
RAM Retention Voltage, V_r (Note 5)	500 ns Rise and Fall Time (Min)	2.0			V
Input Capacitance				7	pF
Load Capacitance on D2				1000	pF

COP880C/COP881C/COP882C

DC Electrical Characteristics (Continued)

Note 1: Rate of voltage change must be less than 0.5V/ms.

Note 2: Supply current is measured after running 2000 cycles with a square wave CKI input, CKO open, inputs at rails and outputs open.

Note 3: The HALT mode will stop CKI from oscillating in the RC and the Crystal configurations. Test conditions: All inputs tied to V_{CC} , L, C and G ports TRI-STATE and tied to ground, all outputs low and tied to ground.

Note 4: Pins G6 and RESET are designed with a high voltage input network for factory testing. These pins allow input voltages greater than V_{CC} and the pins will have sink current to V_{CC} when biased at voltages greater than V_{CC} (the pins do not have source current when biased at a voltage below V_{CC}). The effective resistance to V_{CC} is 750 Ω (typ). These two pins will not latch up. The voltage at the pins must be limited to less than 14V.

Note 5: To maintain RAM integrity, the voltage must not be dropped or raised instantaneously.

AC Electrical Characteristics $-40^{\circ}\text{C} \leq T_A \leq +85^{\circ}\text{C}$ unless otherwise specified

Parameter	Condition	Min	Typ	Max	Units
Instruction Cycle Time (t_c) Crystal/Resonator or External (Div-by 10) R/C Oscillator Mode (Div-by 10)	$V_{CC} \geq 4.5\text{V}$	1		DC	μs
	$2.5\text{V} \leq V_{CC} < 4.5\text{V}$	2.5		DC	μs
	$V_{CC} \geq 4.5\text{V}$	3		DC	μs
	$2.5\text{V} \leq V_{CC} < 4.5\text{V}$	7.5		DC	μs
CKI Clock Duty Cycle (Note 6) Rise Time (Note 6) Fall Time (Note 6)	fr = Max	40		60	%
	fr = 10 MHz Ext Clock			12	ns
	fr = 10 MHz Ext Clock			8	ns
Inputs t_{SETUP} t_{HOLD}	$V_{CC} \geq 4.5\text{V}$	200			ns
	$2.5\text{V} \leq V_{CC} < 4.5\text{V}$	500			ns
	$V_{CC} \geq 4.5\text{V}$	60			ns
	$2.5\text{V} \leq V_{CC} < 4.5\text{V}$	150			ns
Output Propagation Delay t_{PD1} , t_{PD0} SO, SK All Others	$C_L = 100\text{ pF}$, $R_L = 2.2\text{ k}\Omega$				
	$V_{CC} \geq 4.5\text{V}$			0.7	μs
	$2.5\text{V} \leq V_{CC} < 4.5\text{V}$			1.75	μs
	$V_{CC} \geq 4.5\text{V}$ $2.5\text{V} \leq V_{CC} < 4.5\text{V}$			1 2.5	μs μs
MICROWIRE™ Setup Time (t_{UWS}) MICROWIRE Hold Time (t_{UWH}) MICROWIRE Output Propagation Delay (t_{UPD})		20			ns
		56			ns
				220	ns
Input Pulse Width Interrupt Input High Time Interrupt Input Low Time Timer Input High Time Timer Input Low Time		t_c			
		t_c			
		t_c			
		t_c			
Reset Pulse Width		1.0			μs

Note 6: Parameter characterized but not production tested.

Timing Diagram

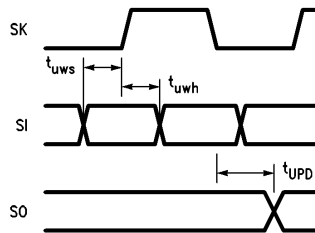

TL/DD/10802-2

FIGURE 2. MICROWIRE/PLUS Timing

COP680C/COP681C/COP682C

Absolute Maximum Ratings

If Military/Aerospace specified devices are required, please contact the National Semiconductor Sales Office/Distributors for availability and specifications.

Supply Voltage (V_{CC})	6V
Voltage at Any Pin	-0.3V to V_{CC} + 0.3V
Total Current into V_{CC} Pin (Source)	40 mA

Total Current Out of GND Pin (Sink)	48 mA
Storage Temperature Range	-65°C to +140°C

Note: Absolute maximum ratings indicate limits beyond which damage to the device may occur. DC and AC electrical specifications are not ensured when operating the device at absolute maximum ratings.

DC Electrical Characteristics COP68xC: -55°C ≤ T_A ≤ +125°C unless otherwise specified

Parameter	Condition	Min	Typ	Max	Units
Operating Voltage		4.5		5.5	V
Power Supply Ripple (Note 1)	Peak to Peak			0.1 V_{CC}	V
Supply Current (Note 2)				8.0	mA
CKI = 10 MHz	$V_{CC} = 5.5V, t_c = 1 \mu s$			4.4	mA
CKI = 4 MHz	$V_{CC} = 5.5V, t_c = 2.5 \mu s$			30	μA
HALT Current (Note 3)	$V_{CC} = 5.5V, CKI = 0 MHz$		< 10		μA
Input Levels					
\overline{RESET} , CKI					
Logic High		0.9 V_{CC}			V
Logic Low				0.1 V_{CC}	V
All Other Inputs					
Logic High		0.7 V_{CC}			V
Logic Low				0.2 V_{CC}	V
Hi-Z Input Leakage	$V_{CC} = 5.5V$	-5		+5	μA
Input Pullup Current	$V_{CC} = 5.5V, V_{IN} = 0V$	-35		-300	μA
G Port Input Hysteresis				0.35 V_{CC}	V
Output Current Levels					
D Outputs					
Source	$V_{CC} = 4.5V, V_{OH} = 3.8V$	-0.35			mA
Sink	$V_{CC} = 4.5V, V_{OL} = 1.0V$	9			mA
All Others					
Source (Weak Pull-Up)	$V_{CC} = 4.5V, V_{OH} = 3.2V$	-9		-120	μA
Source (Push-Pull Mode)	$V_{CC} = 4.5V, V_{OH} = 3.2V$	-0.35			mA
Sink (Push-Pull Mode)	$V_{CC} = 4.5V, V_{OL} = 0.4V$	1.4			mA
TRI-STATE Leakage	$V_{CC} = 5.5V$	-5.0		+5.0	μA
Allowable Sink/Source Current per Pin					
D Outputs (Sink)				12	mA
All Others				2.5	mA
Maximum Input Current (Room Temp) without Latchup (Note 4)	Room Temp			± 100	mA
RAM Retention Voltage, V_r (Note 5)	500 ns Rise and Fall Time (Min)	2.5			V
Input Capacitance				7	pF
Load Capacitance on D2				1000	pF

Note 1: Rate of voltage change must be less than 0.5V/ms.

Note 2: Supply current is measured after running 2000 cycles with a square wave CKI input, CKO open, inputs at rails and outputs open.

Note 3: The HALT mode will stop CKI from oscillating in the RC and the Crystal configurations. Test conditions: All inputs tied to V_{CC} , L and G ports TRI-STATE and tied to ground, all outputs low and tied to ground.

Note 4: Pins G6 and \overline{RESET} are designed with a high voltage input network for factory testing. These pins allow input voltages greater than V_{CC} and the pins will have sink current to V_{CC} when biased at voltages greater than V_{CC} (the pins do not have source current when biased at a voltage below V_{CC}). The effective resistance to V_{CC} is 750 Ω (typical). These two pins will not latch up. The voltage at the pins must be limited to less than 14V.

Note 5: To maintain RAM integrity, the voltage must not be dropped or raised instantaneously.

COP680C/COP681C/COP682C

AC Electrical Characteristics –55°C ≤ T_A ≤ +125°C unless otherwise specified

Parameter	Condition	Min	Typ	Max	Units
Instruction Cycle Time (t _c) Ext. or Crystal/Resonant (Div-by 10)	V _{CC} ≥ 4.5V	1		DC	μs
CKI Clock Duty Cycle (Note 6)	f _r = Max	40		60	%
Rise Time (Note 6)	f _r = 10 MHz Ext Clock			12	ns
Fall Time (Note 6)	f _r = 10 MHz Ext Clock			8	ns
MICROWIRE Setup Time (t _{UWS})		20			ns
MICROWIRE Hold Time (t _{UWH})		56			ns
MICROWIRE Output Valid Time (t _{UPD})				220	ns
Input Pulse Width					
Interrupt Input High Time		t _C			
Interrupt Input Low Time		t _C			
Timer Input High Time		t _C			
Timer Input Low Time		t _C			
Reset Pulse Width		1			μs

Note 6: Parameter characterized but not production tested.

Typical Performance Characteristics ($-40^{\circ}\text{C} \leq T_A \leq +85^{\circ}\text{C}$)

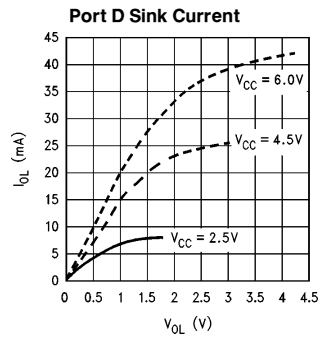
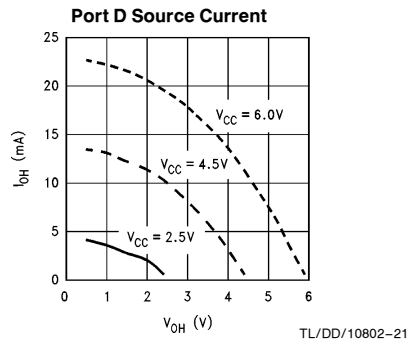
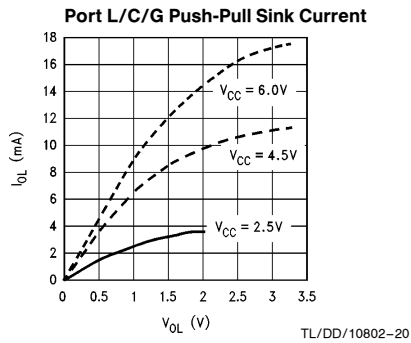
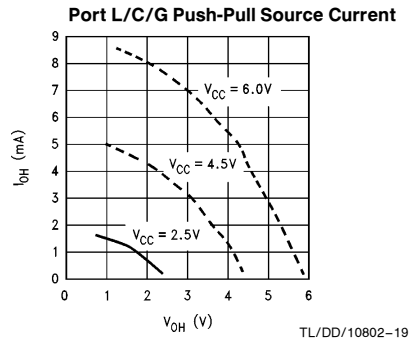
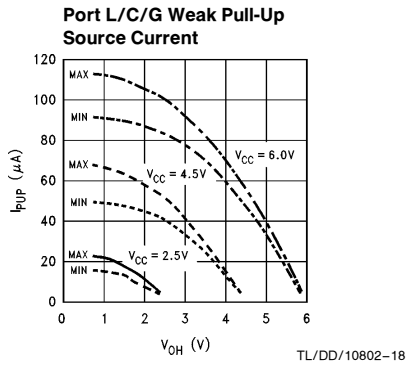
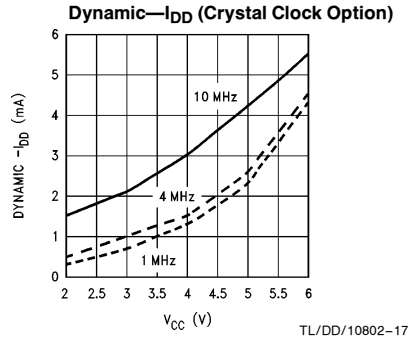
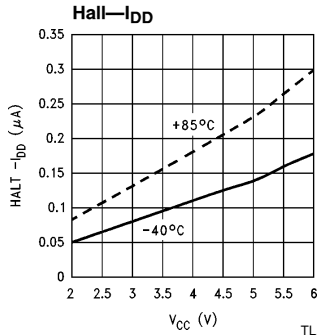

Pin Descriptions

V_{CC} and GND are the power supply pins.

CKI is the clock input. This can come from an external source, a R/C generated oscillator or a crystal (in conjunction with CKO). See Oscillator description.

RESET is the master reset input. See Reset description.

PORT I is an 8-bit Hi-Z input port. The 28-pin device does not have a full complement of Port I pins. The unavailable pins are not terminated i.e., they are floating. A read operation for these unterminated pins will return unpredictable values. The user must ensure that the software takes this into account by either masking or restricting the accesses to bit operations. The unterminated Port I pins will draw power only when addressed.

PORT L is an 8-bit I/O port.

PORT C is a 4-bit I/O port.

Three memory locations are allocated for the L, G and C ports, one each for data register, configuration register and the input pins. Reading bits 4–7 of the C-Configuration register, data register, and input pins returns undefined data.

There are two registers associated with the L and C ports: a data register and a configuration register. Therefore, each L and C I/O bit can be individually configured under software control as shown below:

Config.	Data	Ports L and C Setup
0	0	Hi-Z Input (TRI-STATE Output)
0	1	Input with Pull-Up (Weak One Output)
1	0	Push-Pull Zero Output
1	1	Push-Pull One Output

On the 28-pin part, it is recommended that all bits of Port C be configured as outputs.

PORT G is an 8-bit port with 6 I/O pins (G0–G5) and 2 input pins (G6, G7). All eight G-pins have Schmitt Triggers on the inputs.

There are two registers associated with the G port: a data register and a configuration register. Therefore, each G port bit can be individually configured under software control as shown below:

Config.	Data	Port G Setup
0	0	Hi-Z Input (TRI-STATE Output)
0	1	Input with Pull-Up (Weak One Output)
1	0	Push-Pull Zero Output
1	1	Push-Pull One Output

Since G6 and G7 are input only pins, any attempt by the user to configure them as outputs by writing a one to the configuration register will be disregarded. Reading the G6 and G7 configuration bits will return zeros. The device will be placed in the HALT mode by writing to the G7 bit in the G-port data register.

Six pins of Port G have alternate features:

G0 INTR (an external interrupt)

G3 TIO (timer/counter input/output)

G4 SO (MICROWIRE serial data output)

G5 SK (MICROWIRE clock I/O)

G6 SI (MICROWIRE serial data input)

G7 CKO crystal oscillator output (selected by mask option) or HALT restart input (general purpose input)

Pins G1 and G2 currently do not have any alternate functions.

PORT D is an 8-bit output port that is preset high when RESET goes low. Care must be exercised with the D2 pin operation. At RESET, the external loads on this pin must ensure that the output voltages stay above 0.9 V_{CC} to prevent the chip from entering special modes. Also, keep the external loading on D2 to less than 1000 pF.

Functional Description

Figure 1 shows the block diagram of the internal architecture. Data paths are illustrated in simplified form to depict how the various logic elements communicate with each other in implementing the instruction set of the device.

ALU AND CPU REGISTERS

The ALU can do an 8-bit addition, subtraction, logical or shift operation in one cycle time.

There are five CPU registers:

A is the 8-bit Accumulator register

PU is the upper 7 bits of the program counter (PC)

PL is the lower 8 bits of the program counter (PC)

B is the 8-bit address register, can be auto incremented or decremented.

X is the 8-bit alternate address register, can be incremented or decremented.

SP is the 8-bit stack pointer, points to subroutine stack (in RAM).

B, X and SP registers are mapped into the on chip RAM. The B and X registers are used to address the on chip RAM. The SP register is used to address the stack in RAM during subroutine calls and returns.

PROGRAM MEMORY

Program memory consists of 4096 bytes of ROM. These bytes may hold program instructions or constant data. The program memory is addressed by the 15-bit program counter (PC). ROM can be indirectly read by the LAID instruction for table lookup.

DATA MEMORY

The data memory address space includes on chip RAM, I/O and registers. Data memory is addressed directly by the instruction or indirectly by the B, X and SP registers.

The device has 128 bytes of RAM. Sixteen bytes of RAM are mapped as “registers” that can be loaded immediately, decremented or tested. Three specific registers: B, X and SP are mapped into this space, the other bytes are available for general usage.

The instruction set permits any bit in memory to be set, reset or tested. All I/O and registers (except the A & PC) are memory mapped; therefore, I/O bits and register bits can be directly and individually set, reset and tested. A is not memory mapped, but bit operations can be still performed on it.

Note: RAM contents are undefined upon power-up.

RESET

The $\overline{\text{RESET}}$ input when pulled low initializes the microcontroller. Initialization will occur whenever the $\overline{\text{RESET}}$ input is pulled low. Upon initialization, the ports L, G and C are placed in the TRI-STATE mode and the Port D is set high. The PC, PSW and CNTRL registers are cleared. The data and configuration registers for Ports L, G and C are cleared.

The external RC network shown in Figure 4 should be used to ensure that the $\overline{\text{RESET}}$ pin is held low until the power supply to the chip stabilizes.

Functional Description (Continued)

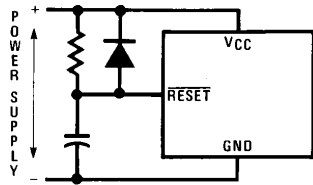

TL/DD/10802-6

RC ≥ 5X Power Supply Rise Time

FIGURE 4. Recommended Reset Circuit

OSCILLATOR CIRCUITS

Figure 5 shows the three clock oscillator configurations.

A. CRYSTAL OSCILLATOR

The device can be driven by a crystal clock. The crystal network is connected between the pins CKI and CKO.

Table I shows the component values required for various standard crystal values.

B. EXTERNAL OSCILLATOR

CKI can be driven by an external clock signal. CKO is available as a general purpose input and/or HALT restart control.

C. R/C OSCILLATOR

CKI is configured as a single pin RC controlled Schmitt trigger oscillator. CKO is available as a general purpose input and/or HALT restart control.

Table II shows the variation in the oscillator frequencies as functions of the component (R and C) values.

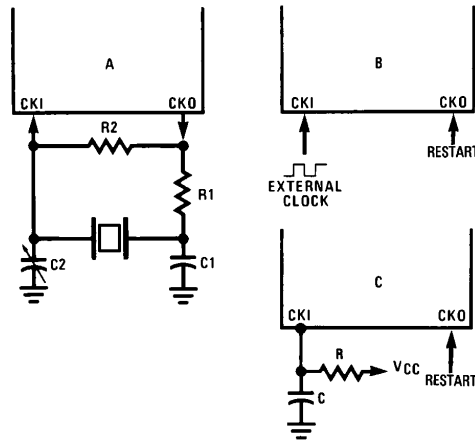

TL/DD/10802-7

FIGURE 5. Crystal and R-C Connection Diagrams

OSCILLATOR MASK OPTIONS

The device can be driven by clock inputs between DC and 10 MHz.

TABLE I. Crystal Oscillator Configuration, $T_A = 25^\circ\text{C}$

R1 (k Ω)	R2 (M Ω)	C1 (pF)	C2 (pF)	CKI Freq (MHz)	Conditions
0	1	30	30-36	10	$V_{CC} = 5V$
0	1	30	30-36	4	$V_{CC} = 2.5V$
5.6	1	200	100-150	0.455	$V_{CC} = 5V$

TABLE II. RC Oscillator Configuration, $T_A = 25^\circ\text{C}$

R (k Ω)	C (pF)	CKI Freq. (MHz)	Instr. Cycle (μs)	Conditions
3.3	82	2.2 to 2.7	3.7 to 4.6	$V_{CC} = 5V$
5.6	100	1.1 to 1.3	7.4 to 9.0	$V_{CC} = 5V$
6.8	100	0.9 to 1.1	8.8 to 10.8	$V_{CC} = 5V$

Note: (R/C Oscillator Configuration): $3k \leq R \leq 200k$, $50 \text{ pF} \leq C \leq 200 \text{ pF}$.

Functional Description (Continued)

The device has three mask options for configuring the clock input. The CKI and CKO pins are automatically configured upon selecting a particular option.

- Crystal (CKI/10); CKO for crystal configuration
- External (CKI/10); CKO available as G7 input
- R/C (CKI/10); CKO available as G7 input

G7 can be used either as a general purpose input or as a control input to continue from the HALT mode.

HALT MODE

The device supports a power saving mode of operation: HALT. The controller is placed in the HALT mode by setting the G7 data bit, alternatively the user can stop the clock input. In the HALT mode all internal processor activities including the clock oscillator are stopped. The fully static architecture freezes the state of the controller and retains all information until continuing. In the HALT mode, power requirements are minimal as it draws only leakage currents and output current. The applied voltage (V_{CC}) may be decreased down to V_r (minimum RAM retention voltage) without altering the state of the machine.

There are two ways to exit the HALT mode: via the $\overline{\text{RESET}}$ or by the CKO pin. A low on the $\overline{\text{RESET}}$ line reinitializes the microcontroller and starts executing from the address 0000H. A low to high transition on the CKO pin (only if the external or R/C clock option selected) causes the microcontroller to continue with no reinitialization from the address following the HALT instruction. This also resets the G7 data bit.

INTERRUPTS

There are three interrupt sources, as shown below.

A maskable interrupt on external G0 input (positive or negative edge sensitive under software control)

A maskable interrupt on timer underflow or timer capture

A non-maskable software/error interrupt on opcode zero

INTERRUPT CONTROL

The GIE (global interrupt enable) bit enables the interrupt function. This is used in conjunction with ENI and ENTI to select one or both of the interrupt sources. This bit is reset when interrupt is acknowledged.

ENI and ENTI bits select external and timer interrupt respectively. Thus the user can select either or both sources to interrupt the microcontroller when GIE is enabled.

IEDG selects the external interrupt edge (0 = rising edge, 1 = falling edge). The user can get an interrupt on both rising and falling edges by toggling the state of IEDG bit after each interrupt.

IPND and TPND bits signal which interrupt is pending. After interrupt is acknowledged, the user can check these two bits to determine which interrupt is pending. This permits the interrupts to be prioritized under software. The pending flags have to be cleared by the user. Setting the GIE bit high inside the interrupt subroutine allows nested interrupts.

The software interrupt does not reset the GIE bit. This means that the controller can be interrupted by other interrupt sources while servicing the software interrupt.

INTERRUPT PROCESSING

The interrupt, once acknowledged, pushes the program counter (PC) onto the stack and the stack pointer (SP) is decremented twice. The Global Interrupt Enable (GIE) bit is reset to disable further interrupts. The microcontroller then vectors to the address 00FFH and resumes execution from that address. This process takes 7 cycles to complete. At the end of the interrupt subroutine, any of the following three instructions return the processor back to the main program: RET, RETSK or RETI. Either one of the three instructions will pop the stack into the program counter (PC). The stack pointer is then incremented twice. The RETI instruction additionally sets the GIE bit to re-enable further interrupts.

Any of the three instructions can be used to return from a hardware interrupt subroutine. The RETSK instruction should be used when returning from a software interrupt subroutine to avoid entering an infinite loop.

Note: There is always the possibility of an interrupt occurring during an instruction which is attempting to reset the GIE bit or any other interrupt enable bit. If this occurs when a single cycle instruction is being used to reset the interrupt enable bit, the interrupt enable bit will be reset but an interrupt may still occur. This is because interrupt processing is started at the same time as the interrupt bit is being reset. To avoid this scenario, the user should always use a two, three or four cycle instruction to reset interrupt enable bits.

Functional Description (Continued)

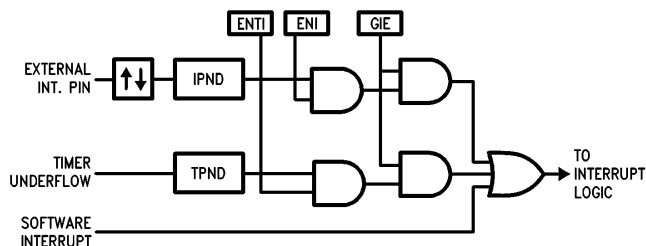

FIGURE 6. Interrupt Block Diagram

TL/DD/10802-8

DETECTION OF ILLEGAL CONDITIONS

The device contains a hardware mechanism that allows it to detect illegal conditions which may occur from coding errors, noise and 'brown out' voltage drop situations. Specifically it detects cases of executing out of undefined ROM area and unbalanced stack situations.

Reading an undefined ROM location returns 00 (hexadecimal) as its contents. The opcode for a software interrupt is also '00'. Thus a program accessing undefined ROM will cause a software interrupt.

Reading an undefined RAM location returns an FF (hexadecimal). The subroutine stack grows down for each subroutine call. By initializing the stack pointer to the top of RAM, the first unbalanced return instruction will cause the stack pointer to address undefined RAM. As a result the program will attempt to execute from FFFF (hexadecimal), which is an undefined ROM location and will trigger a software interrupt.

MICROWIRE/PLUS™

MICROWIRE/PLUS is a serial synchronous bidirectional communications interface. The MICROWIRE/PLUS capability enables the device to interface with any of National Semiconductor's MICROWIRE peripherals (i.e. A/D converters, display drivers, EEPROMS, etc.) and with other microcontrollers which support the MICROWIRE/PLUS interface. It consists of an 8-bit serial shift register (SIO) with serial data input (SI), serial data output (SO) and serial shift clock (SK). Figure 7 shows the block diagram of the MICROWIRE/PLUS interface.

The shift clock can be selected from either an internal source or an external source. Operating the MICROWIRE/PLUS interface with the internal clock source is called the Master mode of operation. Similarly, operating the MICROWIRE/PLUS interface with an external shift clock is called the Slave mode of operation.

The CNTRL register is used to configure and control the MICROWIRE/PLUS mode. To use the MICROWIRE/PLUS, the MSEL bit in the CNTRL register is set to one. The SK clock rate is selected by the two bits, SL0 and SL1, in the CNTRL register. Table III details the different clock rates that may be selected.

TABLE III

SL1	SL0	SK Cycle Time
0	0	$2t_C$
0	1	$4t_C$
1	x	$8t_C$

where,

t_C is the instruction cycle clock.

MICROWIRE/PLUS OPERATION

Setting the BUSY bit in the PSW register causes the MICROWIRE/PLUS arrangement to start shifting the data. It gets reset when eight data bits have been shifted. The user may reset the BUSY bit by software to allow less than 8 bits to shift. The device may enter the MICROWIRE/PLUS mode either as a Master or as a Slave. Figure 8 shows how two COP880C microcontrollers and several peripherals may be interconnected using the MICROWIRE/PLUS arrangement.

Master MICROWIRE/PLUS Operation

In the MICROWIRE/PLUS Master mode of operation the shift clock (SK) is generated internally. The MICROWIRE/PLUS Master always initiates all data exchanges. (See Figure 8). The MSEL bit in the CNTRL register must be set to enable the SO and SK functions onto the G Port. The SO and SK pins must also be selected as outputs by setting appropriate bits in the Port G configuration register. Table IV summarizes the bit settings required for Master mode of operation.

SLAVE MICROWIRE/PLUS OPERATION

In the MICROWIRE/PLUS Slave mode of operation the SK clock is generated by an external source. Setting the MSEL bit in the CNTRL register enables the SO and SK functions onto the G Port. The SK pin must be selected as an input and the SO pin is selected as an output pin by appropriately setting up the Port G configuration register. Table IV summarizes the settings required to enter the Slave mode of operation.

The user must set the BUSY flag immediately upon entering the Slave mode. This will ensure that all data bits sent by the Master will be shifted properly. After eight clock pulses the BUSY flag will be cleared and the sequence may be repeated. (See Figure 8.)

Functional Description (Continued)

TABLE IV

G4 Config. Bit	G5 Config. Bit	G4 Fun.	G5 Fun.	G6 Fun.	Operation
1	1	SO	Int. SK	SI	MICROWIRE Master
0	1	TRI-STATE	Int. SK	SI	MICROWIRE Master
1	0	SO	Ext. SK	SI	MICROWIRE Slave
0	0	TRI-STATE	Ext. SK	SI	MICROWIRE Slave

TIMER/COUNTER

The device has a powerful 16-bit timer with an associated 16-bit register enabling them to perform extensive timer functions. The timer T1 and its register R1 are each organized as two 8-bit read/write registers. Control bits in the register CNTRL allow the timer to be started and stopped under software control. The timer-register pair can be operated in one of three possible modes. Table V details various timer operating modes and their requisite control settings.

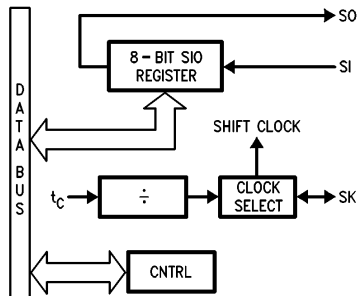

TL/DD/10802-9

FIGURE 7. MICROWIRE/PLUS Block Diagram

MODE 1. TIMER WITH AUTO-LOAD REGISTER

In this mode of operation, the timer T1 counts down at the instruction cycle rate. Upon underflow the value in the register R1 gets automatically reloaded into the timer which continues to count down. The timer underflow can be programmed to interrupt the microcontroller. A bit in the control register CNTRL enables the TIO (G3) pin to toggle upon timer underflows. This allow the generation of square-wave outputs or pulse width modulated outputs under software control. (See Figure 9.)

MODE 2. EXTERNAL COUNTER

In this mode, the timer T1 becomes a 16-bit external event counter. The counter counts down upon an edge on the TIO pin. Control bits in the register CNTRL program the counter to decrement either on a positive edge or on a negative edge. Upon underflow the contents of the register R1 are automatically copied into the counter. The underflow can also be programmed to generate an interrupt. (See Figure 9)

MODE 3. TIMER WITH CAPTURE REGISTER

Timer T1 can be used to precisely measure external frequencies or events in this mode of operation. The timer T1 counts down at the instruction cycle rate. Upon the occurrence of a specified edge on the TIO pin the contents of the timer T1 are copied into the register R1. Bits in the control register CNTRL allow the trigger edge to be specified either as a positive edge or as a negative edge. In this mode the user can elect to be interrupted on the specified trigger edge. (See Figure 10.)

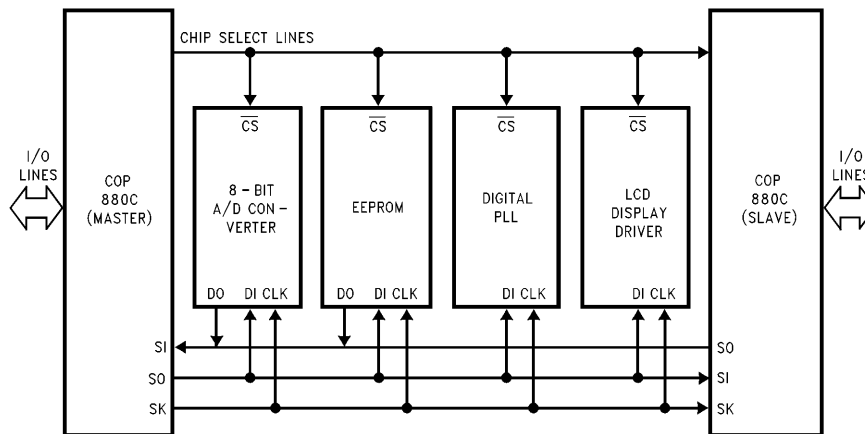

TL/DD/10802-10

FIGURE 8. MICROWIRE/PLUS Application

Functional Description (Continued)

TABLE V. Timer Operating Modes

CNTRL Bits 7 6 5	Operation Mode	T Interrupt	Timer Counts On
0 0 0	External Counter W/Auto-Load Reg.	Timer Underflow	TIO Pos. Edge
0 0 1	External Counter W/Auto-Load Reg.	Timer Underflow	TIO Neg. Edge
0 1 0	Not Allowed	Not Allowed	Not Allowed
0 1 1	Not Allowed	Not Allowed	Not Allowed
1 0 0	Timer W/Auto-Load Reg.	Timer Underflow	t_c
1 0 1	Timer W/Auto-Load Reg./Toggle TIO Out	Timer Underflow	t_c
1 1 0	Timer W/Capture Register	TIO Pos. Edge	t_c
1 1 1	Timer W/Capture Register	TIO Neg. Edge	t_c

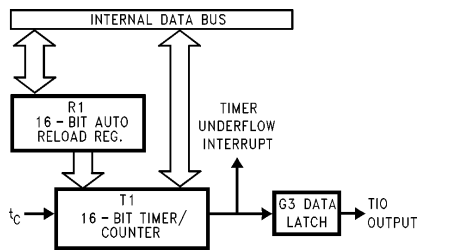

FIGURE 9. Timer/Counter Auto Reload Mode Block Diagram

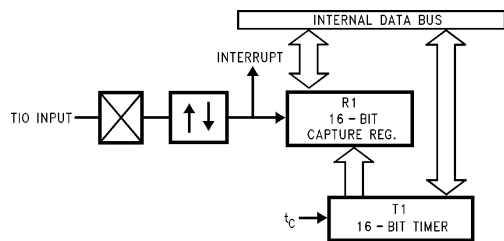

FIGURE 10. Timer Capture Mode Block Diagram

TIMER PWM APPLICATION

Figure 11 shows how a minimal component D/A converter can be built out of the Timer-Register pair in the Auto-Reload mode. The timer is placed in the "Timer with auto reload" mode and the TIO pin is selected as the timer output. At the outset the TIO pin is set high, the timer T1 holds the on time and the register R1 holds the signal off time. Setting TRUN bit starts the timer which counts down at the instruction cycle rate. The underflow toggles the TIO output and copies the off time into the timer, which continues to run. By alternately loading in the on time and the off time at each successive interrupt a PWM frequency can be easily generated.

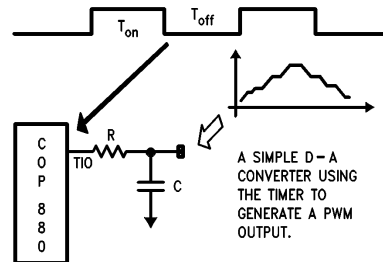

FIGURE 11. Timer Application

TL/DD/10802-13

Control Registers

CNTRL REGISTER (ADDRESS X'00EE)

The Timer and MICROWIRE/PLUS control register contains the following bits:

SL1 & SL0	Select the MICROWIRE/PLUS clock divide-by
IEDG	External interrupt edge polarity select (0 = rising edge, 1 = falling edge)
MSEL	Enable MICROWIRE/PLUS functions SO and SK
TRUN	Start/Stop the Timer/Counter (1 = run, 0 = stop)
TC3	Timer input edge polarity select (0 = rising edge, 1 = falling edge)
TC2	Selects the capture mode
TC1	Selects the timer mode

TC1	TC2	TC3	TRUN	MSEL	IEDG	SL1	SL0
-----	-----	-----	------	------	------	-----	-----

BIT 7 BIT 0

PSW REGISTER (ADDRESS X'00EF)

The PSW register contains the following select bits:

GIE	Global interrupt enable
ENI	External interrupt enable
BUSY	MICROWIRE/PLUS busy shifting
IPND	External interrupt pending
ENTI	Timer interrupt enable
TPND	Timer interrupt pending
C	Carry Flag
HC	Half carry Flag

HC	C	TPND	ENTI	IPND	BUSY	ENI	GIE
----	---	------	------	------	------	-----	-----

Bit 7 Bit 0

Addressing Modes

REGISTER INDIRECT

This is the "normal" mode of addressing. The operand is the memory addressed by the B register or X register.

DIRECT

The instruction contains an 8-bit address field that directly points to the data memory for the operand.

IMMEDIATE

The instruction contains an 8-bit immediate field as the operand.

REGISTER INDIRECT

(AUTO INCREMENT AND DECREMENT)

This is a register indirect mode that automatically increments or decrements the B or X register after executing the instruction.

RELATIVE

This mode is used for the JP instruction, the instruction field is added to the program counter to get the new program location. JP has a range of from -31 to +32 to allow a one byte relative jump (JP + 1 is implemented by a NOP instruction). There are no 'pages' when using JP, all 15 bits of PC are used.

Memory Map

All RAM, ports and registers (except A and PC) are mapped into data memory address space.

Address	Contents
00 to 6F	On Chip RAM Bytes
70 to 7F	Unused RAM Address Space (Reads as all Ones)
80 to BF	Expansion Space for future use
C0 to CF	Expansion Space for I/O and Registers
D0 to DF	On Chip I/O and Registers
D0	Port L Data Register
D1	Port L Configuration Register
D2	Port L Input Pins (Read Only)
D3	Reserved for Port L
D4	Port G Data Register
D5	Port G Configuration Register
D6	Port G Input Pins (Read Only)
D7	Port I Input Pins (Read Only)
D8	Port C Data Register
D9	Port C Configuration Register
DA	Port C Input Pins (Read Only)
DB	Reserved for Port C
DC	Port D Data Register
DD-DF	Reserved for Port D
E0 to EF	On Chip Functions and Registers
E0-E7	Reserved for Future Parts
E8	Reserved
E9	MICROWIRE/PLUS Shift Register
EA	Timer Lower Byte
EB	Timer Upper Byte
EC	Timer Autoload Register Lower Byte
ED	Timer Autoload Register Upper Byte
EE	CNTRL Control Register
EF	PSW Register
F0 to FF	On Chip RAM Mapped as Registers
FC	X Register
FD	SP Register
FE	B Register

Reading unused memory locations below 7FH will return all ones. Reading other unused memory locations will return undefined data.

Instruction Set

REGISTER AND SYMBOL DEFINITIONS

Registers

A	8-bit Accumulator register
B	8-bit Address register
X	8-bit Address register
SP	8-bit Stack pointer register
PC	15-bit Program counter register
PU	upper 7 bits of PC
PL	lower 8 bits of PC
C	1-bit of PSW register for carry
HC	Half Carry
GIE	1-bit of PSW register for global interrupt enable

Symbols

[B]	Memory indirectly addressed by B register
[X]	Memory indirectly addressed by X register
Mem	Direct address memory or [B]
Meml	Direct address memory or [B] or Immediate data
Imm	8-bit Immediate data
Reg	Register memory: addresses F0 to FF (Includes B, X and SP)
Bit	Bit number (0 to 7)
←	Loaded with
↔	Exchanged with

Instruction Set

ADD ADC SUBC AND OR XOR IFEQ IFGT IFBNE DRSZ SBIT RBIT IFBIT	add add with carry subtract with carry Logical AND Logical OR Logical Exclusive-OR IF equal IF greater than IF B not equal Decrement Reg. ,skip if zero Set bit Reset bit If bit	A ← A + Meml A ← A + Meml + C, C ← Carry HC ← Half Carry A ← A + Meml + C, C ← Carry HC ← Half Carry A ← A and Meml A ← A or Meml A ← A xor Meml Compare A and Meml, Do next if A = Meml Compare A and Meml, Do next if A > Meml Do next if lower 4 bits of B ≠ Imm Reg ← Reg - 1, skip if Reg goes to 0 1 to bit, Mem (bit = 0 to 7 immediate) 0 to bit, Mem If bit, Mem is true, do next instr.
X LD A LD mem LD Reg	Exchange A with memory Load A with memory Load Direct memory Immed. Load Register memory Immed.	A ↔ Mem A ← Meml Mem ← Imm Reg ← Imm
X X LD A LD A LD M	Exchange A with memory [B] Exchange A with memory [X] Load A with memory [B] Load A with memory [X] Load Memory Immediate	A ↔ [B] (B ← B ± 1) A ↔ [X] (X ← X ± 1) A ← [B] (B ← B ± 1) A ← [X] (X ← X ± 1) [B] ← Imm (B ← B ± 1)
CLRA INCA DECA LAID DCORA RRCA SWAPA SC RC IFC IFNC	Clear A Increment A Decrement A Load A indirect from ROM DECIMAL CORRECT A ROTATE A RIGHT THRU C Swap nibbles of A Set C Reset C If C If not C	A ← 0 A ← A + 1 A ← A - 1 A ← ROM(PU,A) A ← BCD correction (follows ADC, SUBC) C → A7 → ... → A0 → C A7 ... A4 ↔ A3 ... A0 C ← 1, HC ← 1 C ← 0, HC ← 0 If C is true, do next instruction If C is not true, do next instruction
JMPL JMP JP JSRL JSR JID RET RETSK RETI INTR NOP	Jump absolute long Jump absolute Jump relative short Jump subroutine long Jump subroutine Jump indirect Return from subroutine Return and Skip Return from Interrupt Generate an interrupt No operation	PC ← ii (ii = 15 bits, 0 to 32k) PC11..0 ← i (i = 12 bits) PC ← PC + r (r is -31 to +32, not 1) [SP] ← PL,[SP-1] ← PU,SP-2,PC ← ii [SP] ← PL,[SP-1] ← PU,SP-2,PC11..0 ← i PL ← ROM(PU,A) SP + 2, PL ← [SP], PU ← [SP-1] SP + 2, PL ← [SP], PU ← [SP-1], Skip next instruction SP + 2, PL ← [SP], PU ← [SP-1], GIE ← 1 [SP] ← PL,[SP-1] ← PU,SP-2,PC ← 0FF PC ← PC + 1

Bits 7-4																OPCODE LIST
F	E	D	C	B	A	9	8	7	6	5	4	3	2	1	0	
JP -15	JP -31	LD 0F0, #i	DRSZ 0F0	RRCA	RC	ADC A, #i	ADC A, [B]	IFBIT 0,[B]	*	LD B, 0F	IFBNE 0	JSR 0000-00FF	JMP 0000-00FF	JP + 17	INTR	0
JP -14	JP -30	LD 0F1, #i	DRSZ 0F1	*	SC	SUBC A, #i	SUBC A,[B]	IFBIT 1,[B]	*	LD B, 0E	IFBNE 1	JSR 0100-01FF	JMP 0100-01FF	JP + 18	JP + 2	1
JP -13	JP -29	LD 0F2, #i	DRSZ 0F2	X A, [X+]	X A, [B+]	IFEQ A, #i	IFEQ A,[B]	IFBIT 2,[B]	*	LD B, 0D	IFBNE 2	JSR 0200-02FF	JMP 0200-02FF	JP + 19	JP + 3	2
JP -12	JP -28	LD 0F3, #i	DRSZ 0F3	X A, [X-]	X A, [B-]	IFGT A, #i	IFGT A,[B]	IFBIT 3,[B]	*	LD B, 0C	IFBNE 3	JSR 0300-03FF	JMP 0300-03FF	JP + 20	JP + 4	3
JP -11	JP -27	LD 0F4, #i	DRSZ 0F4	*	LAID	ADD A, #i	ADD A,[B]	IFBIT 4,[B]	CLRA	LD B, 0B	IFBNE 4	JSR 0400-04FF	JMP 0400-04FF	JP + 21	JP + 5	4
JP -10	JP -26	LD 0F5, #i	DRSZ 0F5	*	JID	AND A, #i	AND A,[B]	IFBIT 5,[B]	SWAPA	LD B, 0A	IFBNE 5	JSR 0500-05FF	JMP 0500-05FF	JP + 22	JP + 6	5
JP -9	JP -25	LD 0F6, #i	DRSZ 0F6	X A, [X]	X A, [B]	XOR A, #i	XOR A,[B]	IFBIT 6,[B]	DCORA	LD B, 9	IFBNE 6	JSR 0600-06FF	JMP 0600-06FF	JP + 23	JP + 7	6
JP -8	JP -24	LD 0F7, #i	DRSZ 0F7	*	*	OR A, #i	OR A,[B]	IFBIT 7,[B]	*	LD B, 8	IFBNE 7	JSR 0700-07FF	JMP 0700-07FF	JP + 24	JP + 8	7
JP -7	JP -23	LD 0F8, #i	DRSZ 0F8	NOP	*	LD A, #i	IFC	SBIT 0,[B]	RBIT 0,[B]	LD B, 7	IFBNE 8	JSR 0800-08FF	JMP 0800-08FF	JP + 25	JP + 9	8
JP -6	JP -22	LD 0F9, #i	DRSZ 0F9	*	*	*	IFNC	SBIT 1,[B]	RBIT 1,[B]	LD B, 6	IFBNE 9	JSR 0900-09FF	JMP 0900-09FF	JP + 26	JP + 10	9
JP -5	JP -21	LD 0FA, #i	DRSZ 0FA	LD A, [X+]	LD A, [B+]	LD [B+], #i	INCA	SBIT 2,[B]	RBIT 2,[B]	LD B, 5	IFBNE 0A	JSR 0A00-0AFF	JMP 0A00-0AFF	JP + 27	JP + 11	A
JP -4	JP -20	LD 0FB, #i	DRSZ 0FB	LD A, [X-]	LD A, [B-]	LD [B-], #i	DECA	SBIT 3,[B]	RBIT 3,[B]	LD B, 4	IFBNE 0B	JSR 0B00-0BFF	JMP 0B00-0BFF	JP + 28	JP + 12	B
JP -3	JP -19	LD 0FC, #i	DRSZ 0FC	LD Md, #i	JMPL	X A,Md	*	SBIT 4,[B]	RBIT 4,[B]	LD B, 3	IFBNE 0C	JSR 0C00-0CFF	JMP 0C00-0CFF	JP + 29	JP + 13	C
JP -2	JP -18	LD 0FD, #i	DRSZ 0FD	DIR	JSRL	LD A, Md	RETSK	SBIT 5,[B]	RBIT 5,[B]	LD B, 2	IFBNE 0D	JSR 0D00-0DFF	JMP 0D00-0DFF	JP + 30	JP + 14	D
JP -1	JP -17	LD 0FE, #i	DRSZ 0FE	LD A, [X]	LD A, [B]	LD [B], #i	RET	SBIT 6, [B]	RBIT 6, [B]	LD B, 1	IFBNE 0E	JSR 0E00-0EFF	JMP 0E00-0EFF	JP + 31	JP + 15	E
JP -0	JP -16	LD 0FF, #1	DRSZ 0FF	*	*	*	RETI	SBIT 7,[B]	RBIT 7,[B]	LD B, 0	IFBNE 0F	JSR 0F00-0FFF	JMP 0F00-0FFF	JP + 32	JP + 16	F

where, i is the immediate data Md is a directly addressed memory location * is an unused opcode (see following table)

OPCODE LIST

BITS 3-0

Instruction Execution Time

Most instructions are single byte (with immediate addressing mode instruction taking two bytes).

Most single instructions take one cycle time to execute.

Skipped instructions require x number of cycles to be skipped, where x equals the number of bytes in the skipped instruction opcode.

See the BYTES and CYCLES per INSTRUCTION table for details.

BYTES and CYCLES per INSTRUCTION

The following table shows the number of bytes and cycles for each instruction in the format of byte/cycle.

Arithmetic and Logic Instructions

	[B]	Direct	Immed.
ADD	1/1	3/4	2/2
ADC	1/1	3/4	2/2
SUBC	1/1	3/4	2/2
AND	1/1	3/4	2/2
OR	1/1	3/4	2/2
XOR	1/1	3/4	2/2
IFEQ	1/1	3/4	2/2
IFGT	1/1	3/4	2/2
IFBNE	1/1		
DRSZ		1/3	
SBIT	1/1	3/4	
RBIT	1/1	3/4	
IFBIT	1/1	3/4	

Memory Transfer Instructions

	Register Indirect [B] [X]		Direct	Immed.	Register Indirect Auto Incr & Decr [B+, B-] [X+, X-]	
X A,*	1/1	1/3	2/3		1/2	1/3
LD A,*	1/1	1/3	2/3	2/2	1/2	1/3
LD B,Imm				1/1		
LD B,Imm				2/3		
LD Mem,Imm	2/2		3/3		2/2	
LD Reg,Imm				2/3		

(If B < 16)
(If B > 15)

* => Memory location addressed by B or X or directly.

Instructions Using A & C

CLRA	1/1
INCA	1/1
DECA	1/1
LAID	1/3
DCORA	1/1
RRCA	1/1
SWAPA	1/1
SC	1/1
RC	1/1
IFC	1/1
IFNC	1/1

Transfer of Control Instructions

JMPL	3/4
JMP	2/3
JP	1/3
JSRL	3/5
JSR	2/5
JID	1/3
RET	1/5
RETSK	1/5
RETI	1/5
INTR	1/7
NOP	1/1

BYTES and CYCLES per INSTRUCTION (Continued)

The following table shows the instructions assigned to unused opcodes. This table is for information only. The operations performed are subject to change without notice. Do not use these opcodes.

Unused Opcode	Instruction	Unused Opcode	Instruction
60	NOP	A9	NOP
61	NOP	AF	LD A, [B]
62	NOP	B1	C → HC
63	NOP	B4	NOP
67	NOP	B5	NOP
8C	RET	B7	X A, [X]
99	NOP	B9	NOP
9F	LD [B], #i	BF	LD A, [X]
A7	X A, [B]		
A8	NOP		

Option List

The mask programmable options are listed out below. The options are programmed at the same time as the ROM pattern to provide the user with hardware flexibility to use a variety of oscillator configuration.

OPTION 1: CKI INPUT

- = 1 Crystal (CKI/10) CKO for crystal configuration
- = 2 External (CKI/10) CKO available as G7 input
- = 3 R/C (CKI/10) CKO available as G7 input

OPTION 2: BONDING

- = 1 44-Pin PLCC
- = 2 40-Pin DIP
- = 3 28-Pin SO
- = 4 28-Pin DIP

The following option information is to be sent to National along with the EPROM.

Option Data

- Option 1 Value__is: CKI Input
- Option 2 Value__is: COP Bonding

Development Support

SUMMARY

- iceMASTER™: IM-COP8/400—Full feature in-circuit emulation for all COP8 products. A full set of COP8 Basic and Feature Family device and package specific probes are available.
- COP8 Debug Module: Moderate cost in-circuit emulation and development programming unit.
- COP8 Evaluation and Programming Unit: EPU-COP880C—low cost In-circuit simulation and development programming unit.
- Assembler: COP8-DEV-IBMA. A DOS installable cross development Assembler, Linker, Librarian and Utility Software Development Tool Kit.
- C Compiler: COP8C. A DOS installable cross development Software Tool Kit.
- OTP/EPROM Programmer Support: Covering needs from engineering prototype, pilot production to full production environments.

Development Support (Continued)

iceMASTER (IM) IN-CIRCUIT EMULATION

The iceMASTER IM-COP8/400 is a full feature, PC based, in-circuit emulation tool developed and marketed by Meta-Link Corporation to support the whole COP8 family of products. National is a resale vendor for these products.

See Figure 12 for configuration.

The iceMASTER IM-COP8/400 with its device specific COP8 Probe provides a rich feature set for developing, testing and maintaining product:

- Real-time in-circuit emulation; full 2.4V–5.5V operation range, full DC-10 MHz clock. Chip options are programmable or jumper selectable.
- Direct connection to application board by package compatible socket or surface mount assembly.
- Full 32 kbyte of loadable programming space that overlays (replaces) the on-chip ROM or EPROM. On-chip RAM and I/O blocks are used directly or recreated on the probe as necessary.
- Full 4k frame synchronous trace memory. Address, instruction, and 8 unspecified, circuit connectable trace lines. Display can be HLL source (e.g., C source), assembly or mixed.
- A full 64k hardware configurable break, trace on, trace off control, and pass count increment events.
- Tool set integrated interactive symbolic debugger—supports both assembler (COFF) and C Compiler (.COD) linked object formats.
- Real time performance profiling analysis; selectable bucket definition.
- Watch windows, content updated automatically at each execution break.
- Instruction by instruction memory/register changes displayed on source window when in single step operation.
- Single base unit and debugger software reconfigurable to support the entire COP8 family; only the probe personality needs to change. Debugger software is processor customized, and reconfigured from a master model file.
- Processor specific symbolic display of registers and bit level assignments, configured from master model file.
- Halt/Idle mode notification.
- On-line HELP customized to specific processor using master model file.
- Includes a copy of COP8-DEV-IBMA assembler and linker SDK.

IM Order Information

Base Unit	
IM-COP8/400-1	iceMASTER base unit, 110V power supply
IM-COP8/400-2	iceMASTER base unit, 220V power supply
iceMASTER Probe	
MHW-880C20DWPC	20 DIP
MHW-880C28DWPC	28 DIP
MHW-880CJ40DWPC	40 DIP
MHW-880CJ44PWPC	44 PLCC
DIP to SO Adapters	
MHW-SOIC20	20 SO
MHW-SOIC28	28 DIP

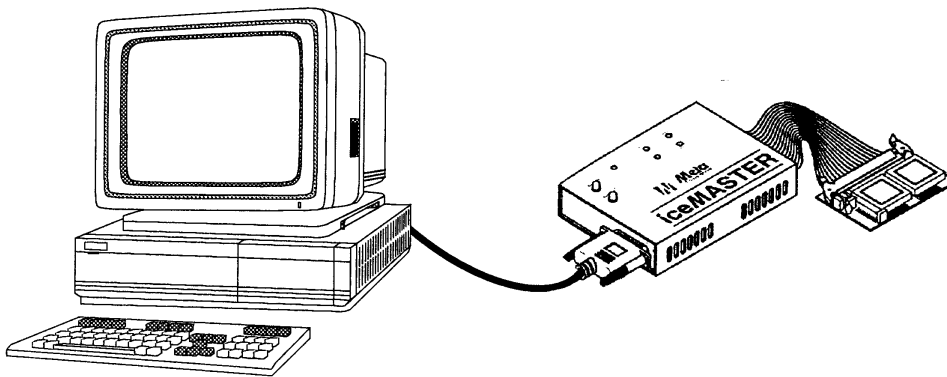

FIGURE 12. COP8 iceMASTER Environment

TL/DD/10802-24

Development Support (Continued)

iceMASTER DEBUG MODULE (DM)

The iceMASTER Debug Module is a PC based, combination in-circuit emulation tool and COP8 based OTP/EPROM programming tool developed and marketed by MetaLink Corporation to support the whole COP8 family of products. National is a resale vendor for these products.

See *Figure 13* for configuration.

The iceMASTER Debug Module is a moderate cost development tool. It has the capability of in-circuit emulation for a specific COP8 microcontroller and in addition serves as a programming tool for COP8 OTP and EPROM product families. Summary of features is as follows:

- Real-time in-circuit emulation; full operating voltage range operation, full DC-10 MHz clock.
- All processor I/O pins can be cabled to an application development board with package compatible cable to socket and surface mount assembly.
- Full 32 kbyte of loadable programming space that overlays (replaces) the on-chip ROM or EPROM. On-chip RAM and I/O blocks are used directly or recreated as necessary.
- 100 frames of synchronous trace memory. The display can be HLL source (C source), assembly or mixed. The most recent history prior to a break is available in the trace memory.
- Configured break points; uses INTR instruction which is modestly intrusive.
- Software—only supported features are selectable.
- Tool set integrated interactive symbolic debugger—supports both assembler (COFF) and C Compiler (.COD) SDK linked object formats.
- Instruction by instruction memory/register changes displayed when in single step operation.
- Debugger software is processor customized, and reconfigured from a master model file.

- Processor specific symbolic display of registers and bit level assignments, configured from master model file.
- Halt/Idle mode notification.
- Programming menu supports full product line of programmable OTP and EPROM COP8 products. Program data is taken directly from the overlay RAM.
- Programming of 44 PLCC and 68 PLCC parts requires external programming adapters.
- Includes wallmount power supply.
- On-board VPP generator from 5V input or connection to external supply supported. Requires VPP level adjustment per the family programming specification (correct level is provided on an on-screen pop-down display).
- On-line HELP customized to specific processor using master model file.
- Includes a copy of COP8-DEV-IBMA assembler and linker SDK.

DM Order Information

Debug Model Unit	
COP8-DM/880C	
Cable Adapters	
DM-COP8/20D	20 DIP
DM-COP8/28D	28 DIP
DM-COP8/40D	40 DIP
DM-COP8/44P	44 PLCC
DIP to SO Adapters	
DM-COP8/20D-SO	20 SO
DM-COP8/28D-SO	28 SO

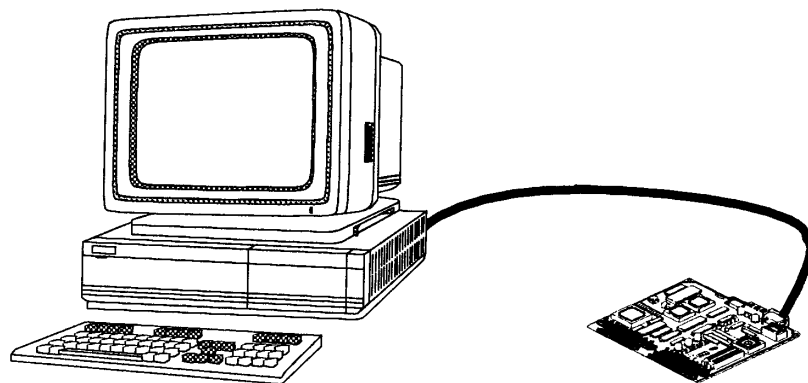

FIGURE 13. COP8-DM Environment

TL/DD/10802-25

Development Support (Continued)

iceMASTER EVALUATION PROGRAMMING UNIT (EPU)

The iceMASTER EPU-COP880C is a PC based, in-circuit simulation tool to support the feature family COP8 products. See *Figure 14* for configuration.

The simulation capability is a very low cost means of evaluating the general COP8 architecture. In addition, the EPU has programming capability, with added adapters, for programming the whole COP8 product family of OTP and EPROM products. The product includes the following features:

- Non-real-time in-circuit simulation. Program overlay memory is PC resident; instructions are downloaded over RS-232 as executed. Approximate performance is 20 kHz.
 - Includes a 40 pin DIP cable adapter. Other target packages are not supported. All processor I/O pins are cabled to the application development environment.
 - Full 32 kbyte of loadable programmable space that overlays (replaces) the on-chip ROM or EPROM. On-chip RAM and I/O blocks are used directly or recreated as necessary.
 - On-chip timer and WATCHDOG execution are not well synchronized to the instruction simulation.
 - 100 frames of synchronous trace memory. The display can be HLL source (e.g., C source), assembly or mixed. The most recent history prior to a break is available in the trace memory.
 - Up to eight software configured break points; uses INTR instruction which is modestly intrusive.
 - Common look-feel debugger software across all Meta-Link products—only supported features are selectable.
- Tool set integrated interactive symbolic debugger—supports both assembler (COFF) and C Compiler (.COD) SDK linked object formats.
 - Instruction by instruction memory/register changes displayed when in single step operation.
 - Processor specific symbolic display of registers and bit level assignments, configured from master model file.
 - Halt/Idle mode notification. Restart requires special handling.
 - Programming menu supports full product line of programmable OTP and EPROM COP8 products. Only a 40 ZIF socket is available on the EPU unit. Adapters are available for other part package configurations.
 - Integral wall mount power supply provides 5V and develops the required V_{PP} to program parts.
 - Includes a copy of COP8-DEV-IBMA assembler, linker SDK.

EPU Order Information

Evaluation Programming Unit	
EPU-COP880C	Evaluation Programming Unit with debugger and programmer control software with 40 ZIF programming socket.
General Programming Adapters	
COP8-PGMA-DS	28 and 20 DIP and SOIC adapter
COP8-PGMA-DS44P	28 and 20 DIP and SOIC plus 44 PLCC adapter

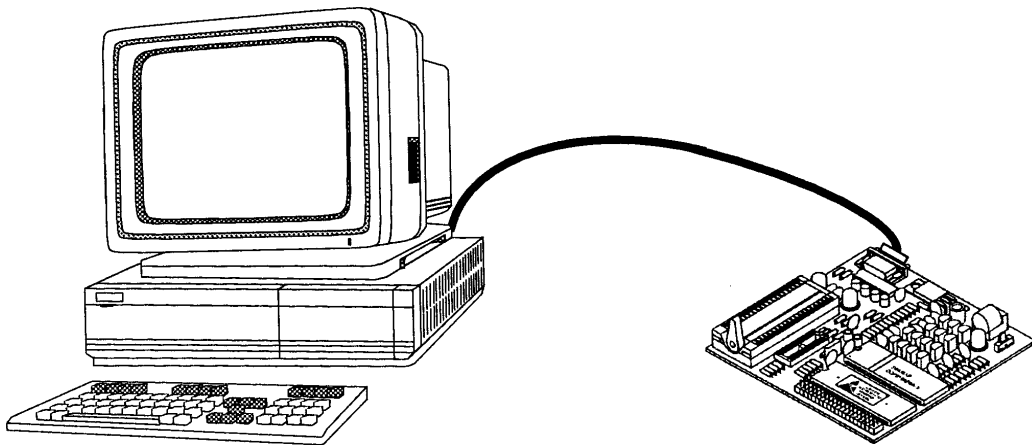

FIGURE 14. EPU-COP8 Tool Environment

TL/DD/10802-26

Development Support (Continued)

COP8 ASSEMBLER/LINKER SOFTWARE DEVELOPMENT TOOL KIT

National Semiconductor offers a relocateable COP8 macro cross assembler, linker, librarian and utility software development tool kit. Features are summarized as follows:

- Basic and Feature Family instruction set by "device" type.
- Nested macro capability.
- Extensive set of assembler directives.
- Supported on PC/DOS platform.
- Generates National standard COFF output files.
- Integrated Linker and Librarian.
- Integrated utilities to generate ROM code file outputs.
- DUMPCOFF utility.

This product is integrated as a part of MetaLink tools as a development kit, fully supported by the MetaLink debugger. It may be ordered separately or it is bundled with the MetaLink products at no additional cost.

Order Information

Assembler SDK:	
COP8-DEV-IBMA	Assembler SDK on installable 3.5" PC/DOS Floppy Disk Drive format. Periodic upgrades and most recent version is available on National's BBS and Internet.

COP8 C COMPILER

A C Compiler is developed and marketed by Byte Craft Limited. The COP8C compiler is a fully integrated development tool specifically designed to support the compact embedded configuration of the COP8 family of products.

Features are summarized as follows:

- ANSI C with some restrictions and extensions that optimize development for the COP8 embedded application.
- BITS data type extension. Register declaration #pragma with direct bit level definitions.
- C language support for interrupt routines.
- Expert system, rule based code generation and optimization.
- Performs consistency checks against the architectural definitions of the target COP8 device.
- Generates program memory code.
- Supports linking of compiled object or COP8 assembled object formats.
- Global optimization of linked code.
- Symbolic debug load format fully sourced level supported by the MetaLink debugger.

INDUSTRY WIDE OTP/EPROM PROGRAMMING SUPPORT

Programming support, in addition to the MetaLink development tools, is provided by a full range of independent approved vendors to meet the needs from the engineering laboratory to full production.

Approved List

Manufacturer	North America	Europe	Asia
BP Microsystems	(800) 225-2102 (713) 688-4600 Fax: (713) 688-0920	+ 49-8152-4183 + 49-8856-932616	+ 852-234-16611 + 852-2710-8121
Data I/O	(800) 426-1045 (206) 881-6444 Fax: (206) 882-1043	+ 44-0734-440011	Call North America
HI-LO	(510) 623-8860	Call Asia	+ 886-2-764-0215 Fax: + 886-2-756-6403
ICE Technology	(800) 624-8949 (919) 430-7915	+ 44-1226-767404 Fax: 0-1226-370-434	
MetaLink	(800) 638-2423 (602) 926-0797 Fax: (602) 693-0681	+ 49-80 9156 96-0 Fax: + 49-80 9123 86	+ 852-737-1800
Systems General	(408) 263-6667	+ 41-1-9450300	+ 886-2-917-3005 Fax: + 886-2-911-1283
Needhams	(916) 924-8037 Fax: (916) 924-8065		

Development Support (Continued)

AVAILABLE LITERATURE

For more information, please see the COP8 Basic Family User's Manual, Literature Number 620895, COP8 Feature Family User's Manual, Literature Number 620897 and National's Family of 8-bit Microcontrollers COP8 Selection Guide, Literature Number 630009.

DIAL-A-HELPER SERVICE

Dial-A-Helper is a service provided by the Microcontroller Applications group. The Dial-A-Helper is an Electronic Information System that may be accessed as a Bulletin Board System (BBS) via data modem, as an FTP site on the Internet via standard FTP client application or as an FTP site on the Internet using a standard Internet browser such as Netscape or Mosaic.

The Dial-A-Helper system provides access to an automated information storage and retrieval system. The system capabilities include a MESSAGE SECTION (electronic mail, when accessed as a BBS) for communications to and from the Microcontroller Applications Group and a FILE SECTION which consists of several file areas where valuable application software and utilities could be found.

DIAL-A-HELPER BBS via a Standard Modem

Modem: CANADA/U.S.: (800) NSC-MICRO
(800) 672-6427
EUROPE: (+49) 0-8141-351332
Baud: 14.4k
Set-Up: Length: 8-Bit
Parity: None
Stop Bit: 1
Operation: 24 Hours, 7 Days

DIAL-A-HELPER via FTP

ftp nscmicro.nsc.com
user: anonymous
password: username@yourhost.site.domain

DIAL-A-HELPER via WorldWide Web Browser

ftp://nscmicro.nsc.com

National Semiconductor on the WorldWide Web

See us on the WorldWide Web at: <http://www.national.com>

CUSTOMER RESPONSE CENTER

Complete product information and technical support is available from National's customer response centers.

CANADA/U.S.:	Tel:	(800)272-9959
	email:	support@tevm2.nsc.com
EUROPE:	email:	europa.support@nsc.com
	Deutsch Tel:	+ 49 (0) 180-530 85 85
	English Tel:	+ 49 (0) 180-532 78 32
	Français Tel:	+ 49 (0) 180-532 93 58
	Italiano Tel:	+ 49 (0) 180-534 16 80
JAPAN:	Tel:	+ 81-043-299-2309
S.E. ASIA:	Beijing Tel:	(+ 86) 10-6856-8601
	Shanghai Tel:	(+ 86) 21-6415-4092
	Hong Kong Tel:	(+ 852) 2737-1600
	Korea Tel:	(+ 82) 2-3771-6909
	Malaysia Tel:	(+ 60-4) 644-9061
	Singapore Tel:	(+ 65) 255-2226
	Taiwan Tel:	+ 886-2-521-3288
AUSTRALIA:	Tel:	(+ 61) 3-9558-9999
INDIA:	Tel:	(+ 91) 80-559-9467

Physical Dimensions inches, (millimeters)

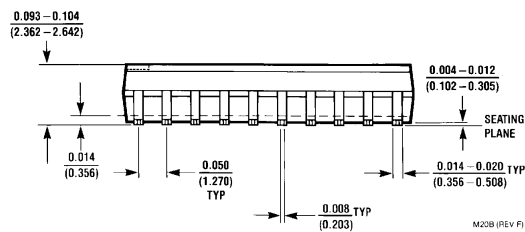
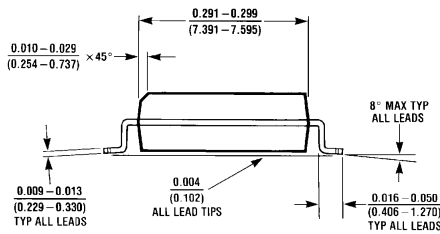
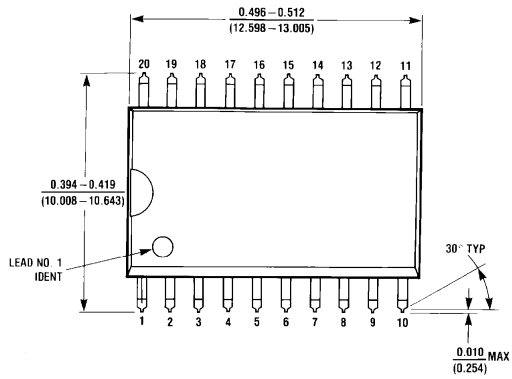

M20B (REV F)

Small Outline Molded Dual-In-Line Package (M)
Order Number COP882C-XXX/WM, COP982C-XXX/WM, COP682C-XXX/WM or COP982CH-XXX/WM
NS Package Number M20B

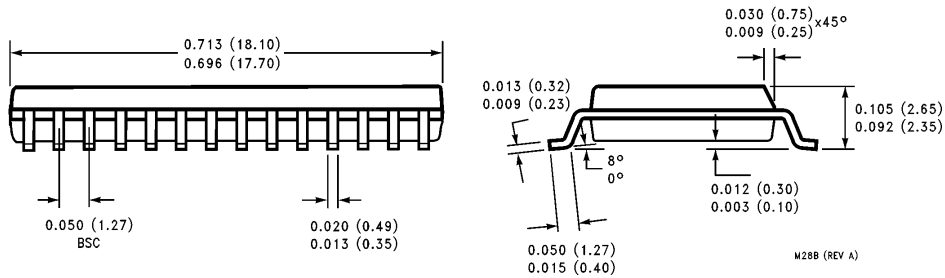
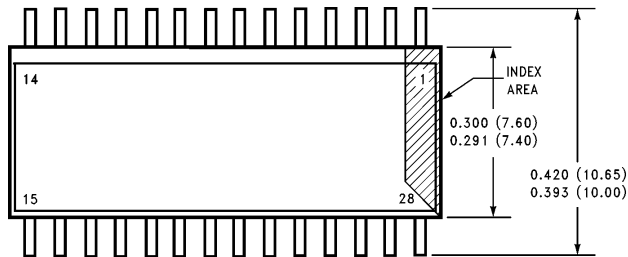

M28B (REV A)

Small Outline Molded Dual-In-Line Package (M)
Order Number COP881C-XXX/WM, COP981C-XXX/WM, COP681C-XXX/WM or COP981CH-XXX/WM
NS Package Number M28B

Physical Dimensions inches, (millimeters)

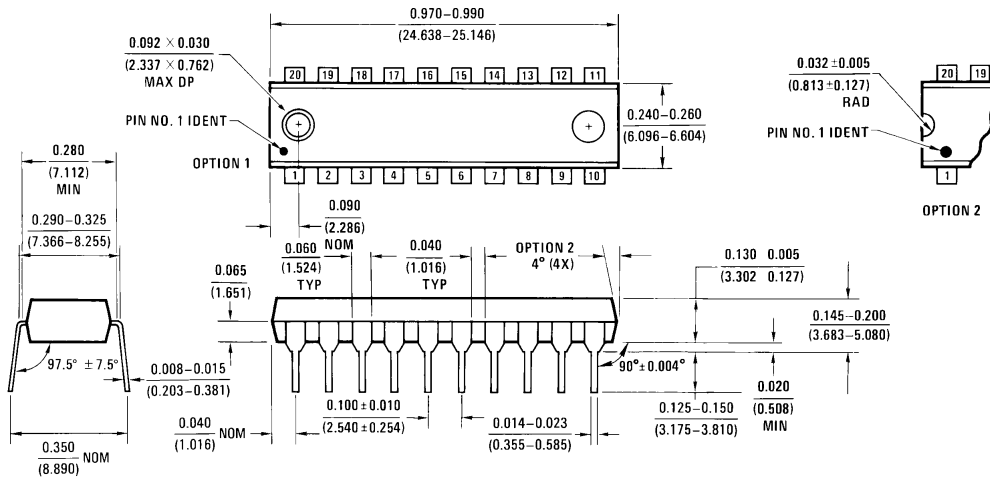

N20B (REV A)

Molded Dual-In-Line Package (N)
Order Number COP882C-XXX/N, COP682C-XXX/N, COP982C-XXX/N or COP982CH-XXX/N
NS Package Number N20B

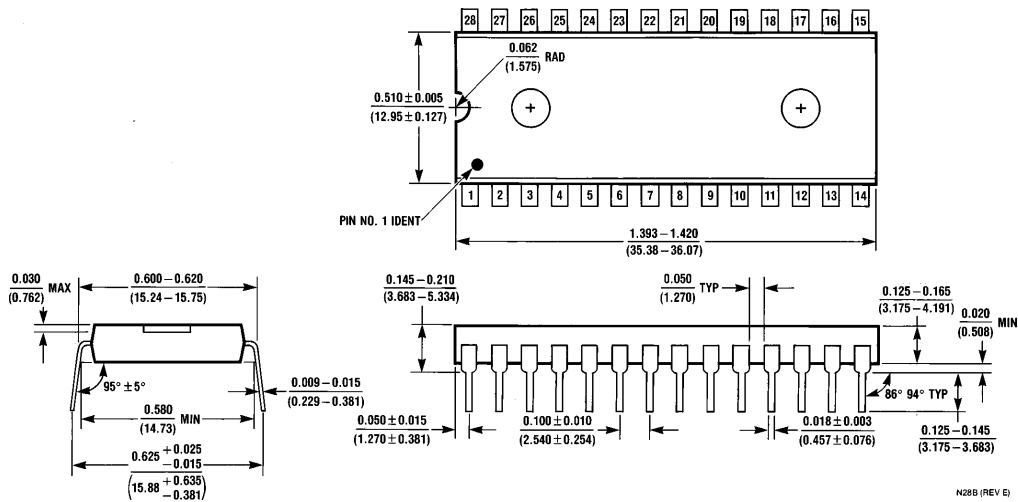

N28B (REV E)

Molded Dual-In-Line Package (N)
Order Number COP881C-XXX/N, COP681C-XXX/N, COP981C-XXX/N or COP981CH-XXX/N
NS Package Number N28B

Physical Dimensions inches, (millimeters) (Continued)

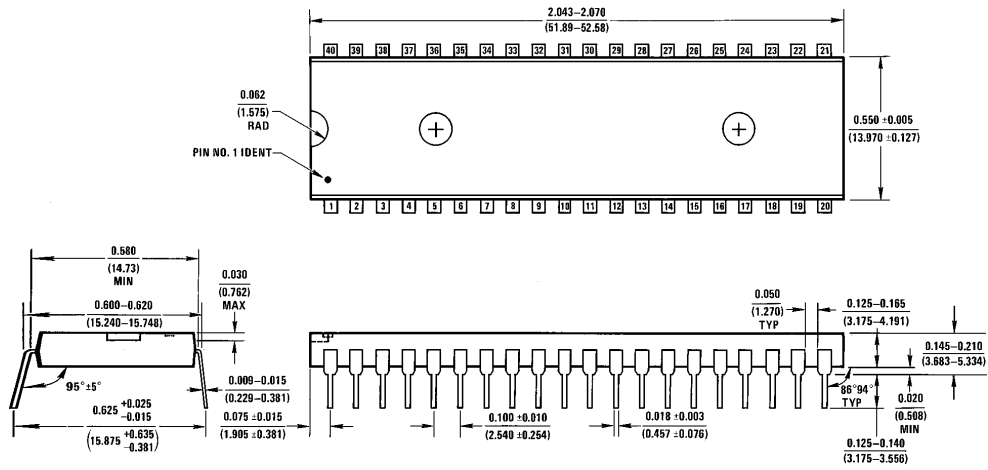

MOA (REV E)

Molded Dual-In-Line Package (N)
Order Number COP880C-XXX/N, COP680C-XXX/N, COP980C-XXX/N or COP980CH-XXX/N
NS Package Number N40A

Physical Dimensions inches (millimeters) unless otherwise noted (Continued)

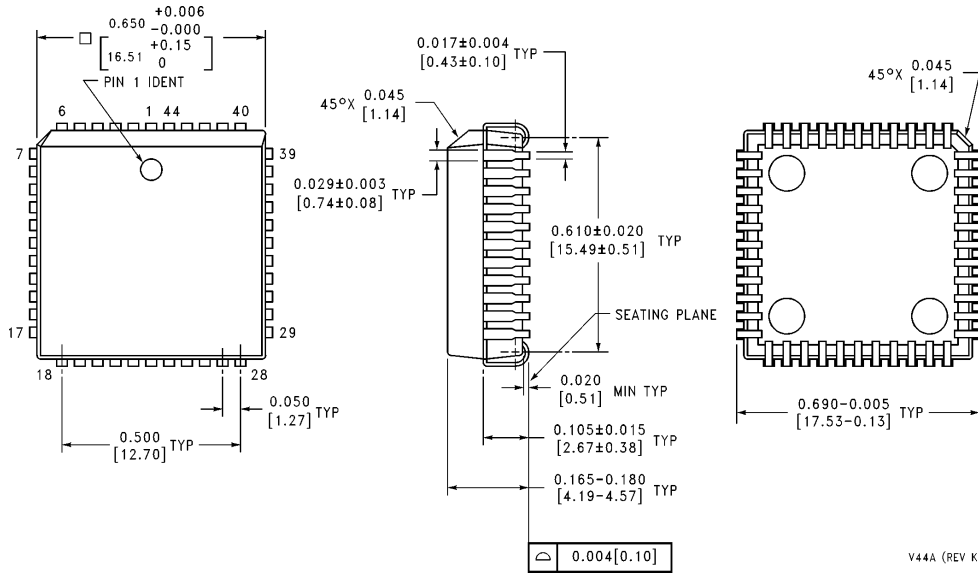

V44A (REV K)

Plastic Leaded Chip Carrier (V)

Order Number COP880C-XXX/V, COP680C-XXX/V, COP980C-XXX/V or COP980CH-XXX/V
NS Package Number V44A

LIFE SUPPORT POLICY

NATIONAL'S PRODUCTS ARE NOT AUTHORIZED FOR USE AS CRITICAL COMPONENTS IN LIFE SUPPORT DEVICES OR SYSTEMS WITHOUT THE EXPRESS WRITTEN APPROVAL OF THE PRESIDENT OF NATIONAL SEMICONDUCTOR CORPORATION. As used herein:

1. Life support devices or systems are devices or systems which, (a) are intended for surgical implant into the body, or (b) support or sustain life, and whose failure to perform, when properly used in accordance with instructions for use provided in the labeling, can be reasonably expected to result in a significant injury to the user.
2. A critical component is any component of a life support device or system whose failure to perform can be reasonably expected to cause the failure of the life support device or system, or to affect its safety or effectiveness.



National Semiconductor Corporation
1111 West Bardin Road
Arlington, TX 76017
Tel: (800) 272-9959
Fax: (800) 737-7018

<http://www.national.com>

National Semiconductor Europe

Fax: +49 (0) 180-530 85 86
Email: europe.support@nsc.com
Deutsch Tel: +49 (0) 180-530 85 85
English Tel: +49 (0) 180-532 78 32
Français Tel: +49 (0) 180-532 93 58
Italiano Tel: +49 (0) 180-534 16 80

National Semiconductor Hong Kong Ltd.

19th Floor, Straight Block,
Ocean Centre, 5 Canton Rd.
Tsimshatsui, Kowloon
Hong Kong
Tel: (852) 2737-1600
Fax: (852) 2736-9960

National Semiconductor Japan Ltd.

Tel: 81-043-299-2308
Fax: 81-043-299-2408

National Semiconductor was acquired by Texas Instruments.

http://www.ti.com/corp/docs/investor_relations/pr_09_23_2011_national_semiconductor.html

This file is the datasheet for the following electronic components:

COP881C - <http://www.ti.com/product/cop881c?HQS=TI-null-null-dscatalog-df-pf-null-ww>

COP680C - <http://www.ti.com/product/cop680c?HQS=TI-null-null-dscatalog-df-pf-null-ww>

COP981C - <http://www.ti.com/product/cop981c?HQS=TI-null-null-dscatalog-df-pf-null-ww>

COP980C - <http://www.ti.com/product/cop980c?HQS=TI-null-null-dscatalog-df-pf-null-ww>

COP682C - <http://www.ti.com/product/cop682c?HQS=TI-null-null-dscatalog-df-pf-null-ww>

COPC680 - <http://www.ti.com/product/copc680?HQS=TI-null-null-dscatalog-df-pf-null-ww>

COPC681 - <http://www.ti.com/product/copc681?HQS=TI-null-null-dscatalog-df-pf-null-ww>

COPC682 - <http://www.ti.com/product/copc682?HQS=TI-null-null-dscatalog-df-pf-null-ww>

COP882C - <http://www.ti.com/product/cop882c?HQS=TI-null-null-dscatalog-df-pf-null-ww>

COP681C - <http://www.ti.com/product/cop681c?HQS=TI-null-null-dscatalog-df-pf-null-ww>

COPC880 - <http://www.ti.com/product/copc880?HQS=TI-null-null-dscatalog-df-pf-null-ww>

COP982C - <http://www.ti.com/product/cop982c?HQS=TI-null-null-dscatalog-df-pf-null-ww>

COP880C - <http://www.ti.com/product/cop880c?HQS=TI-null-null-dscatalog-df-pf-null-ww>

COPC881 - <http://www.ti.com/product/copc881?HQS=TI-null-null-dscatalog-df-pf-null-ww>

COPC882 - <http://www.ti.com/product/copc882?HQS=TI-null-null-dscatalog-df-pf-null-ww>

COPC980 - <http://www.ti.com/product/copc980?HQS=TI-null-null-dscatalog-df-pf-null-ww>

COPC981 - <http://www.ti.com/product/copc981?HQS=TI-null-null-dscatalog-df-pf-null-ww>

COPC982 - <http://www.ti.com/product/copc982?HQS=TI-null-null-dscatalog-df-pf-null-ww>



LittleDiode supplies new, hard to find or obsolete electronic components and semiconductors all over the world.

With over two million different components listed you are sure to find the part you need.

Feel free to visit us today at our online store:

LittleDiode.com

Looking forward to providing you with the best possible service.