

SONY® CX20037A/CXA1237AR

Audio Signal Processing for VTR

Description

CX20037A/CXA1237AR is a bipolar IC which has been developed for the processing of VTR audio signals, and by performing frequency modulation/demodulation and noise reduction operations, it enables high performance record/playback. Its capabilities include the following functions:

Frequency modulator, Frequency demodulator, Hold circuit, Low pass filter, Dropout detector, Mute detector, PB amplifier, Limiter, Overmodulation limiter, AGC amplifier, Line amplifier, Earphone amplifier, Input selector, and Noise reduction circuit.

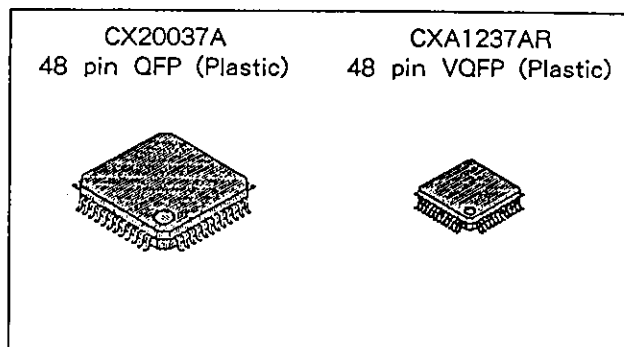

Features

- Single-chip integration of a frequency modulation/demodulation system and a noise reduction system.
- A broad power supply voltage range by virtue of a built-in regulator (4.5V to 7.0V: Single power supply)
- A low distortion, low drift frequency modulator
- Built-in line amplifier, earphone amplifier, and AGC amplifier
- A logarithmic compressing/expanding "compander" (Companding factor: 2) operated noise reduction system
- Reduced noise modulation (noise reduction) by a fixed preemphasis system
- Less peripheral components

Block Diagram and Pin Configuration

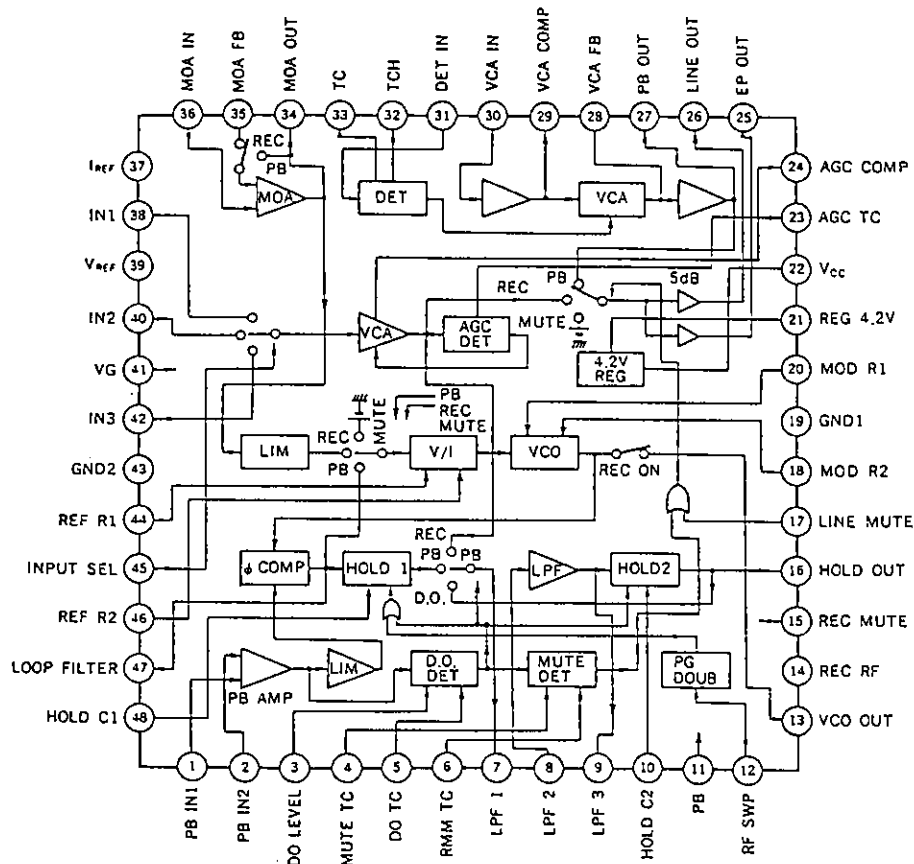

Absolute Maximum Ratings (Ta=25°)

• Supply voltage	Vcc	10	V
• Operating temperature	Topr	-20 to +75	°C
• Storage temperature	Tstg	-55 to +150	°C
• Allowable power dissipation	Pd	920	mW (CX20037A)
		1100*	mW (CXA1237AR)

Recommended Operating Condition

• Supply voltage	Vcc	4.5 to 7.0	V	When mounted on the ceramic board 40 mm × 25 mm t=0.635m
------------------	-----	------------	---	---

Pin Description

No.	Symbol	Description	DC (V)	AC (V)	Impedance (Ω)
1	PB IN1	Amplifies PB FM wave by 40dB. Preamp input pin.	1.8 (PB)		10k
2	PB IN2	↑ (PB FM input)	1.8 (PB)	10mVp-p (PB)	10k
3	DO LEVEL	Sets the dropout detector level.	—		H*1
4	MUTE TC	Connects a muting time constant (in a Mute Off mode).	3.5 (PB)		50k
5	DO TC	Connects a dropout detector time constant.	1.4 (PB)		L*2
6	RMM TC	Connects a muting mode hold time constant (0V in Mute On mode).	4.2 (PB)		H
7	LPF1	Connects CR for the demodulator output LPF.	2.1	-15dBm	L
8	LPF2	↑ (OP. amp input)	2.1	↑	H
9	LPF3	↑ (OP. amp output)	2.1	↑	L
10	HOLD C2	Connects a hold time constant for the prior level hold circuit serving for dropout detection (in a Hold Off mode).	2.8	↑	H
11	PB	REC/PB switching control pin 5 to 4V→PB, 1 to 0V→REC	0		50k
12	RF SWP	Inputs timing pulses which serve for engaging a prior level hold mode at the RF switching position. 5 to 4V→High, 2 to 0V→Low	0		50k
13	VCO OUT	Modulator output pin	3.3		1k
14	REC RF	LPF output pin	0		1k
15	REC MUTE	Control pin to suspend modulating operations 5 to 3.8V→Mute, 2.6 to 0V→Normal	0		50k
16	HOLD OUT	Prior level hold circuit output pin	2.1	-15dBm	L
17	LINE MUTE	Control pin to mute the line and EP outputs 5 to 3.8V→Mute, 2.0 to 0V→Normal	0		50k

No.	Symbol	Description	DC (V)	AC (V)	Impedance (Ω)
18	MOD R2	Connects a reference resistor to determine the modulator oscillating frequency. $f \approx 1.5\text{MHz}$	3.90	0.5	820
19	GND1	Ground level for other than the PB amplifier and LIM	0		
20	MOD R1	Connects a reference resistor to determine the modulator oscillating frequency. $f \approx 1.5\text{MHz}$	3.90	0.5	820
21	REG 4.2V	4.2V regulator output	4.2		
22	Vcc	$V_{cc} = 4.5$ to 7.0V	5.0		
23	AGC TC	Determines the attack and recovery time constant for AGC.	1.9		$\approx 20\text{k}$ (static)
24	AGC COMP	Exercises the AGC amplifier phase compensation.	2.65		H
25	EP OUT	EP amplifier output pin	2.1		L
26	LINE OUT	Line amplifier output pin, having a 5dB gain.	2.1		L
27	PB OUT	PB output pin of the NR circuit	2.1		L
28	VCA FB	Inverting input pin of the VCA output amplifier. Performs the I \rightarrow V conversion.	2.1		H
29	VCA COMP	Exercises the VCA phase compensation.	2.1		750
30	VCA IN	VCA input pin. Imaginarily short-circuited to VG and serves as a current input.	2.1		L
31	DET IN	Detector input pin. DC biased internally, and serves as a current input.	1.30		L
32	TCH	Determines the detector hold time constant.	2.60		$\approx 5\text{k}$ (static)
33	TC	Smoothens full-wave rectified waveforms of the detector. In addition, it determines the attack and recovery time constant.	2.05		$\approx 50\text{k}$ (static)
34	MOA OUT	REC Out pin of the noise reduction circuit.	2.1		L
35	MOA FB	Inverting input pin of MOA. Feeds the PB output back into the REC mode.	2.1		H
36	MOA IN	Input pin of the NR circuit	2.1		10k
37	IREF	Reference current input pin of the noise reduction detector.	0.80		$\approx 3\text{k}$
38	IN1	Audio signal input pin from line/tuner/camera.	2.1	-29 to +1 dBm	20k

No.	Symbol	Description	DC (V)	AC (V)	Impedance (Ω)
39	VREF	VCA reference voltage serving the noise reduction circuit and AGC amplifier, with the maximum output current at 4mA.	1.95		10
40	IN2	Audio signal input pin from line/tuner/camera.	2.1	-29 to +1dBm	20k
41	VG	Neutral potential ($V_{CC}/2$) pin, with the maximum output current at +1mA -200 μ A	2.1		130
42	IN3	Audio signal input pin from line/tuner/camera.	2.1	-29 to +1dBm	20k
43	GND2	Ground for the PB amplifier and LIM	0		
44	REF R1	Connects a reference resistor to set the frequency deviation. Modulator input signal	2.1	-15dBm	L
45	INPUT SEL	Switches the input to pins 38, 40 and 42, at three values: IN=5 to 3.6V, IN2=High Z, IN1=0.4 to 0V	2.1		13.8k
46	REF R2	Connects a reference resistor to set the frequency deviation. Modulator input signal	2.1		L
47	LOOP FILTER	Demodulator output	—		H
48	HOLD C1	Connects a hold time constant for the prior level hold circuit serving the RF switching position.	2.8 (PB)	-15dBm (PB)	H

Note*1) H is approximately 500 k Ω minimum

*2) L is approximately 50 Ω maximum

Functions

1. AGC Amplifier

Cover range: -29 dBm to +1 dBm
 Full gain: 20 dB

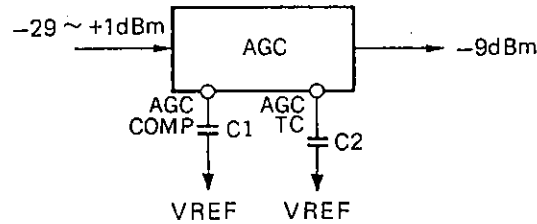

C1: Phase compensating capacitor

C2: Determines the attack and recovery time constant, and its connection to VREF will improve the AGC distortion factor.

2. Noise Reduction

(1) Main OP amplifier

Being switched internally, behaves as a voltage follower in the PB mode, or provides encoding characteristics by incorporating the decoder circuit in the OP amplifier negative feedback loop during recording.

(2) Voltage-controlled amplifier

The voltage-controlled amplifier consists of a current divider of input and output, and the impedance elements (used in common with emphasis) are connected to before and after of the voltage controlled amplifier to convert it voltage to current and the current to voltage.

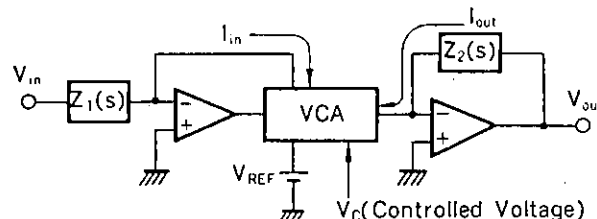

The voltage-controlled amplifier exhibits a control sensitivity level at 0.33 dB/mV, and its gain is determined relative to the reference voltage (VREF). Specifically, when set at $V_{REF} - V_c = 30$ mV, for example, its voltage-controlled gain will be made 10 dB.

By assuming G as the voltage-controlled gain of the above circuit, the following interrelation may be obtained.

$$V_{out} = V_{in} \cdot G \cdot Z_2(s) / Z_1(s)$$

When defining $I_o = I_{in} + I_{out}$, the maximum I_o value of the voltage-controlled amplifier becomes 1.4 mA p-p.

(3) Detector

To accommodate a broad dynamic range, the detector has been made to a current input type and performs logarithmic conversions. Since the detector input has been DC biased, cutting of the DC with C1 becomes necessary. When so arranged, input current I_{in} will meet the equation below.

$$I_{in} = V_{in} / Z(s)$$

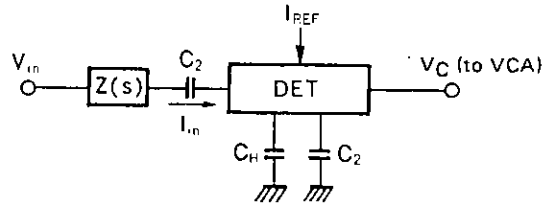

Control voltage V_C of the voltage-controlled amplifier is a function of the ratio of its input current (I_{in}) to the reference current, and when reference current = $100 \mu A$, input current = $81.4 \mu A$ rms and

$$V_C = V_{REF} \text{ (VCA Gain = 0 dB)}$$

will result.

The recovery time constant is determined by C_2 , and since it has been set rather short, a high level ripple component of the detector output will result and low band distortions due to intermodulation will also be increased. Accordingly, a capacitor (C_H) has been employed to suppress the peaks of the full-wave rectified waveform, for an improved distortion factor at a shorter recovery time constant.

3. Line Amplifier

The line amplifier exhibits a fixed 5 dB gain.

4. Earphone Amplifier

The earphone amplifier being basically a voltage follower, its gain is adjusted by varying the value of its protective resistor.

5. LIM (Deviation Limiter)

Being an overmodulation preventive limiter, the limiting level is fixed at -10.5 dBm (650 mVp-p). It will behave as a voltage follower in the presence of a signal below -10 dBm in level.

6. VCO (Voltage-controlled Oscillator)

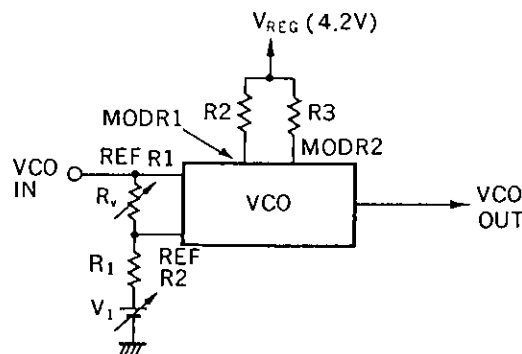

The VCO's f_0 ($\approx 1.5 \text{ MHz}$) is determined by a capacitor incorporated and externally connected R_2 and R_3 resistors, but may be adjusted by either sinking or forcing a current into pin 46 (REF R_2) through R_1 and V_1 .

The frequency deviation may be adjusted by varying the variable resistor (R_v).

7. Demodulator

A PLL detecting process has been employed for the demodulator that has been structured with a VCO (voltage-controlled oscillator), PC (phase comparator), and loop filter.

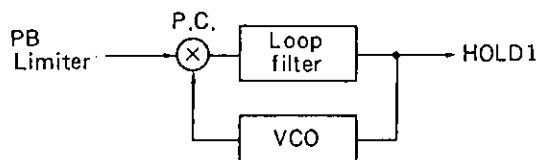

8. Hold 1

Normally this circuit behaves as a low pass filter, but when a dropout has occurred or RF switching pulses (pin 12) have been switched, it will perform hold operations.

9. Hold 2

Similarly to Hold 1, this circuit also behaves normally as a low pass filter, but in the presence of a dropout, it will hold a delayed phase signal from the low pass filter (pin 9 output).

10. PG (Pulse Generator Doubler)

PG generates pulse signals to engage holding operations of the Hold 1 circuit at the rising and falling of the RF switching pulses. The generated pulse width will be about 10 μ sec.

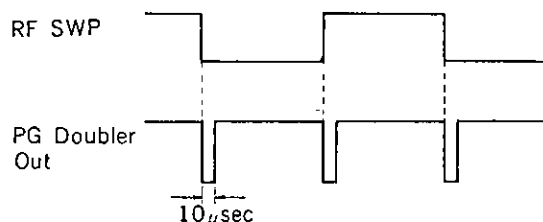

11. Dropout Detector

Upon detecting a dropout, this circuit will engage holding operations of the Hold 1 and 2 circuits. The full-wave rectified waveform input will be smoothed by a capacitor connected to the DO TC (pin 5), and the dropout level set by a DC potential at DO LEVEL (pin 3).

12. Muting Detector

When upon detecting a dropout and its time duration is found to be long, this circuit will mute both Line out and EP out. The dropout duration to activate muting circuits has been set at about 500 μ sec, but may be varied with the capacitor connected to MUTE TC (pin 4). The muting hold time (about 30 msec) is set with a capacitor connected to RMMTC (pin 6) (Muting Mode Recovery).

Current consumption vs. Supply voltage

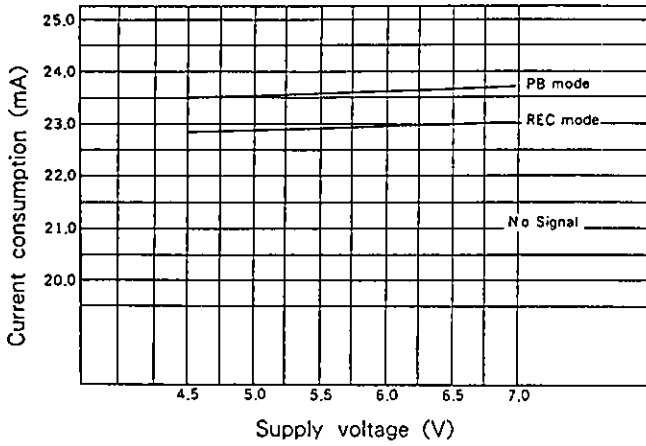

4.2V regulator output vs. Supply voltage

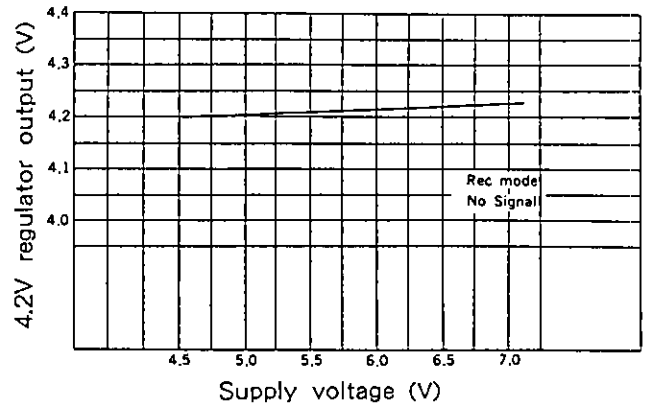

Noise reduction frequency characteristics

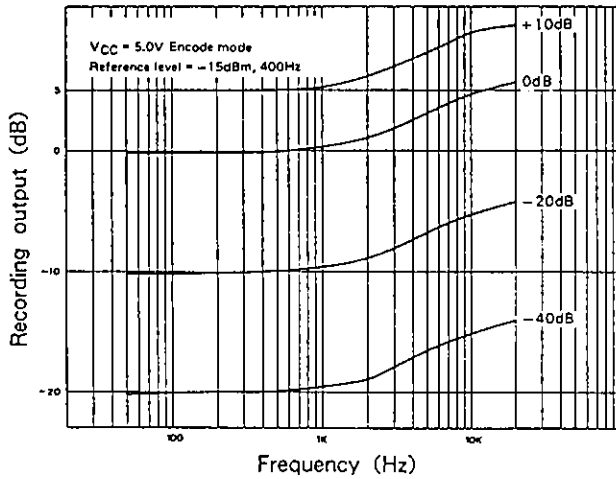

Noise reduction distortion factor vs. Output level

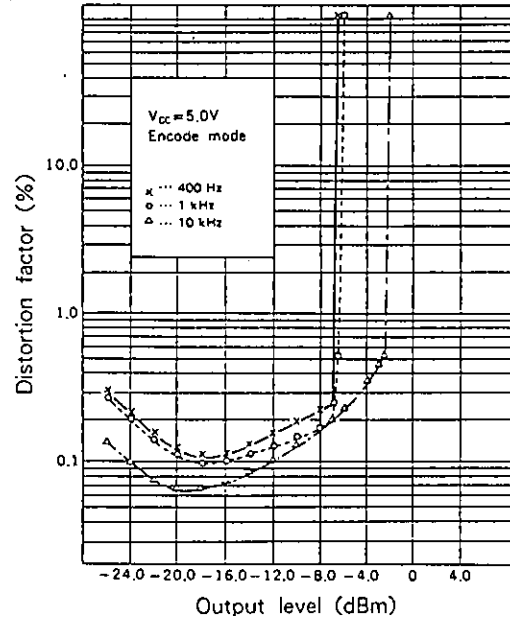

Line output distortion factor vs. Input signal (EP amp at no load)

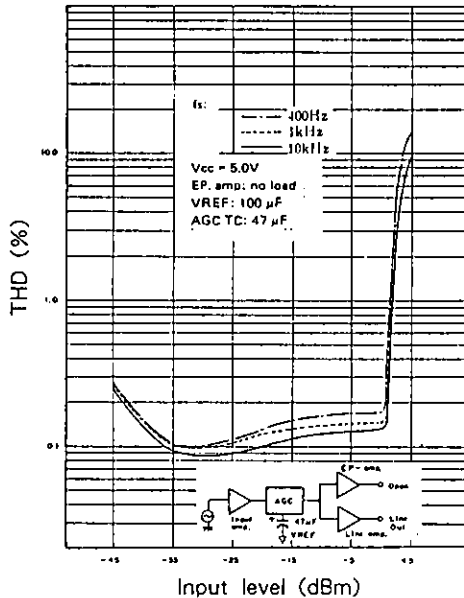

Line output distortion factor vs. Input signal (EP amp at load)

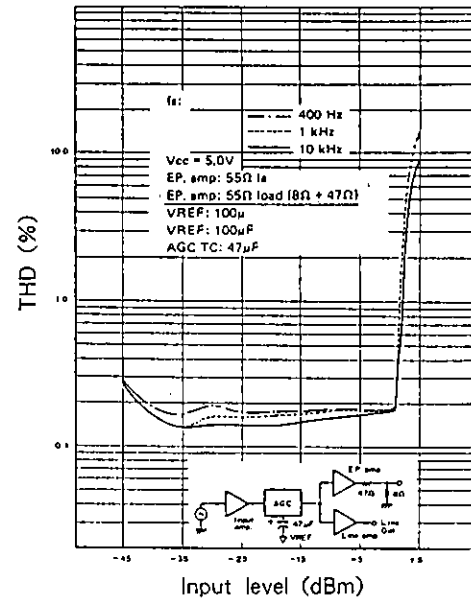

AGC cover range

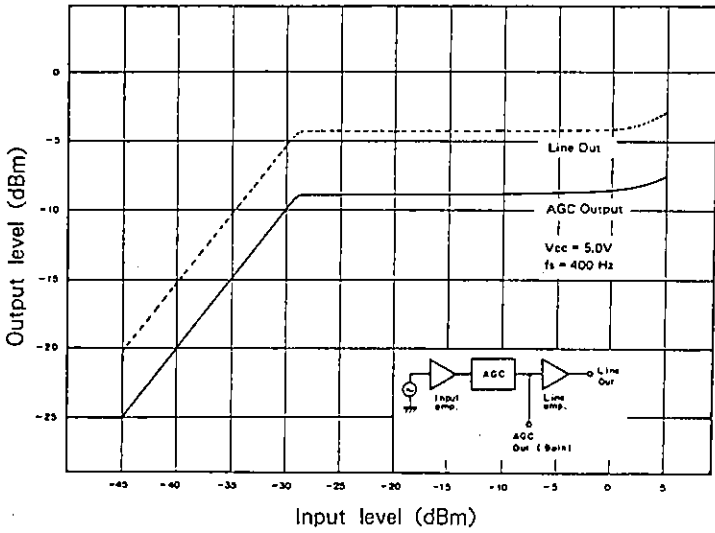

Line out level temperature characteristics

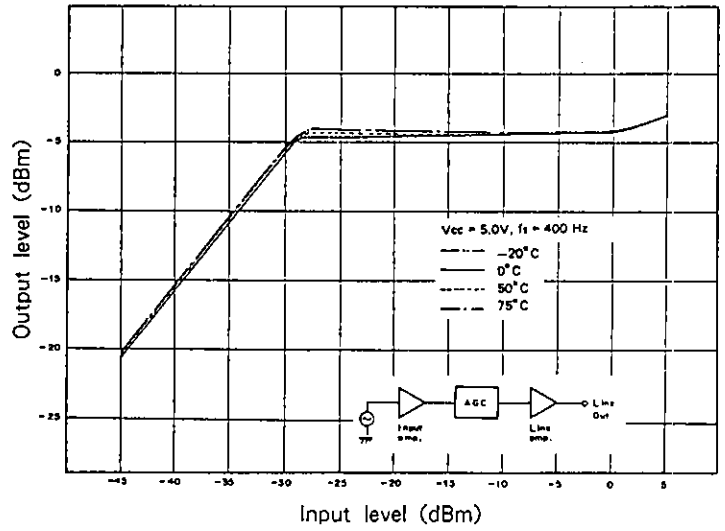

Demodulator noise level and AM rejection vs. Input level

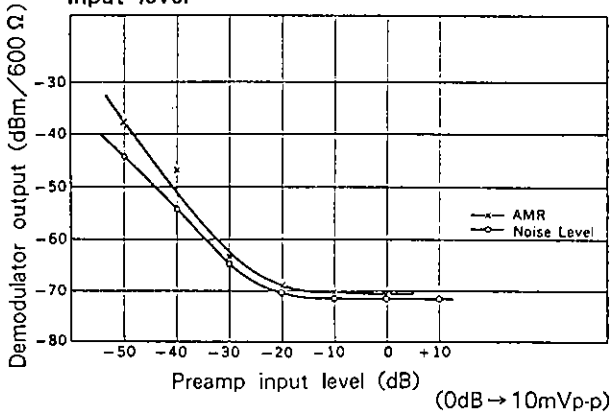

Modulator carrier temperature characteristics

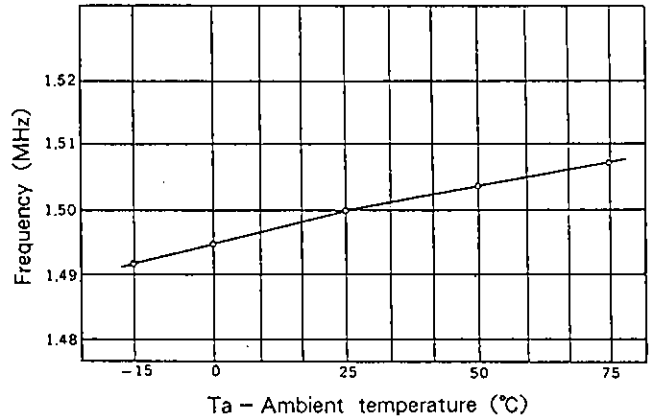

Frequency deviation temperature characteristics

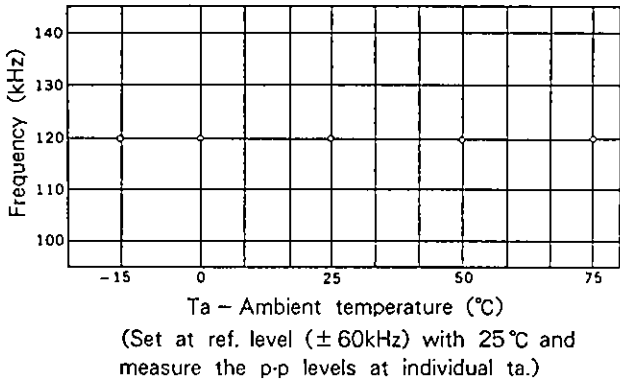

Modulator output level temperature characteristics

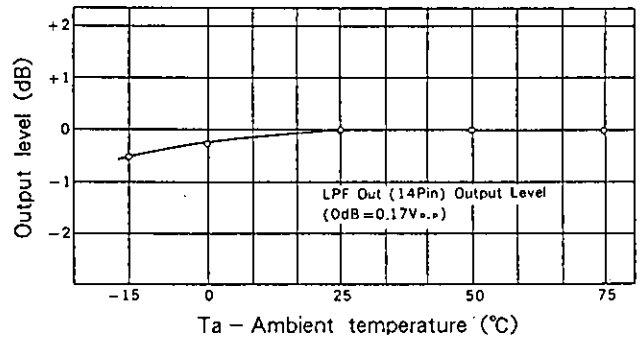



LittleDiode supplies new, hard to find or obsolete electronic components and semiconductors all over the world.

With over two million different components listed you are sure to find the part you need.

Feel free to visit us today at our online store:

LittleDiode.com

Looking forward to providing you with the best possible service.