

All Band TV Tuner IC (VHF-CATV-UHF)

Description

The CXA1664M is a single chip TV tuner IC which performs as an oscillator, mixer for VHF/CATV and UHF bands. An IF amplifier is also provided.

This IC adopts a 16-pin SOP package in response to the trend toward miniaturizing the tuner and automatic IC mounting. This IC achieves a large reduction of external parts in addition to miniaturizing the tuner and increasing manufacturing productivity, reliability and design efficiency.

This IC has the reverse pin configuration to the CXA1665M.

Features

- On-chip oscillator and mixer for UHF band
- Low noise figure
- Reduced spurious interference
- Superior cross modulation distortion
- Stable oscillating characteristics

Absolute Maximum Ratings (Ta=25°C)

- Supply voltage V_{cc} 11 V
- Storage temperature T_{stg} -65 to +150 °C
- Allowable power dissipation P_d 980 mW
(When mounted on a board)

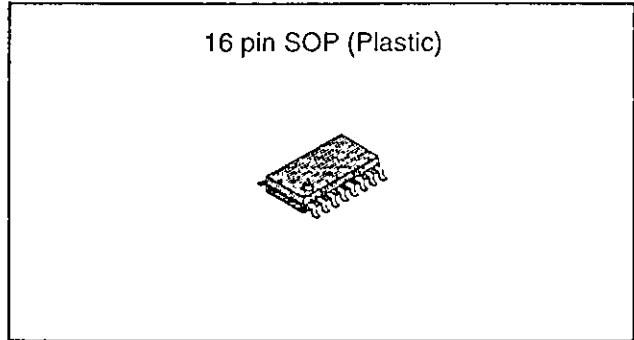

Applications

- CTV tuner
- CATV UP-DOWN converter
- FM detector for 2nd IF satellite broadcasts

Structure

Bipolar silicon monolithic IC

Operating Conditions

- Supply voltage V_{cc} 9.0±0.9 V
- Operating temperature T_{opr} -20 to +75 °C

Block Diagram and Pin Configuration (Top View)

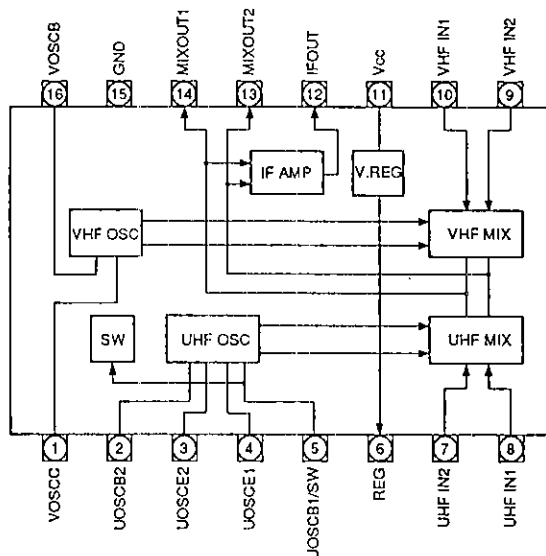

Sony reserves the right to change products and specifications without prior notice. This information does not convey any license by any implication or otherwise under any patents or other right. Application circuits shown, if any, are typical examples illustrating the operation of the devices. Sony cannot assume responsibility for any problems arising out of the use of these circuits.

Pin Description and Equivalent Circuit

Pin No.	Symbol	Typical voltage (V)	Equivalent circuit	Description
1	VOSC C	Under VHF operation; 6.7 Under UHF operation; 9.0		VHF oscillator.
16	VOSC B	3.5 3.7		
2	UOSC B2	3.7 3.4		UHF oscillator. Pin 5 is used for both U/V switches.
3	UOSC E2	3.2 2.6		
4	UOSC E1	0 2.6		
5	UOSC B1/SW	0 3.4		
6	REG	6.0		
7	UHF IN2	3.3 3.2		UHF input. The balanced input to Pins 7 and 8, or a decoupling capacitor is connected at Pin 7 to GND and Pin 8 is used for input.
8	UHF IN1	3.3 3.2		

Pin No.	Symbol	Typical voltage (V)	Equivalent circuit	Description
9	VHF IN2	3.2		VHF input; normally a decoupling capacitor is connected at Pin 10 to GND and Pin 9 is used for input.
		3.3		
10	VHF IN1	3.2		
		3.3		
11	Vcc	9		Power supply.
12	IF OUT	4.5		IF output.
		4.5		
13	MIX OUT2	7.5		Mixer output and IF amplifier input.
		7.3		
14	MIX OUT1	7.5		
		7.3		
15	GND	0		GND

Electrical Characteristics

(See Electrical Characteristics Test Circuit. Ta=25°C, Vcc=9V)

Item	Symbol	Condition	Min.	Typ.	Max.	Unit
Circuit current	IccV	VHF operation; no signal	30	45	58	mA
	IccU	UHF operation; no signal	29	44	57	mA
Conversion gain *1	CG1	VHF operation; fRF=55MHz; Input level -40dBm	20	23	26	dB
	CG2	VHF operation; fRF=360MHz; Input level -40dBm	20	23	26	dB
	CG3	UHF operation; fRF=360MHz; Input level -40dBm	25	28	31	dB
	CG4	UHF operation; fRF=800MHz; Input level -40dBm	25	28	31	dB
Noise figure *1 *2	NF1	VHF operation; fRF=55MHz		10	13	dB
	NF2	VHF operation; fRF=360MHz		10	13	dB
	NF3	UHF operation; fRF=360MHz		7	11	dB
	NF4	UHF operation; fRF=800MHz		8	12	dB
1% cross modulation *1 *3	CM1	VHF operation; fd=55MHz, fUD=±12MHz	96	100		dB μ
	CM2	VHF operation; fd=360MHz, fUD=±12MHz	94	98		dB μ
	CM3	UHF operation; fd=360MHz, fUD=±12MHz	88	92		dB μ
	CM4	UHF operation; fd=800MHz, fUD=±12MHz	87	91		dB μ
Max. output power	Pomax (sat)	50 Ω load	+8	+11		dBm
Switch ON drift	Δ fsw1	VHF operation; fosc=100MHz frequency drift for the time from 3s to 3min after switch ON			±300	kHz
	Δ fsw2	VHF operation; fosc=405MHz frequency drift for the time from 3s to 3min after switch ON			±500	kHz
	Δ fsw3	UHF operation; fosc=405MHz frequency drift for the time from 3s to 3min after switch ON			±500	kHz
	Δ fsw4	UHF operation; fosc=845MHz frequency drift for the time from 3s to 3min after switch ON			±500	kHz
+B supply voltage drift	Δ fst1	VHF operation; fosc=100MHz frequency shift when Vcc+9V changes ±5%			±200	kHz
	Δ fst2	VHF operation; fosc=405MHz frequency shift when Vcc+9V changes ±5%			±250	kHz
	Δ fst3	UHF operation; fosc=405MHz frequency shift when Vcc+9V changes ±5%			±250	kHz
	Δ fst4	UHF operation; fosc=845MHz frequency shift when Vcc+9V changes ±5%			±250	kHz

*1) Measured value for untuned inputs.

*2) Noise figure is uncorrected for image.

*3) Desired signal (fd) input level is -33dBm.

undesired signal (fUD) is 100kHz at 30% AM.

The measurement value is undesired signal level, it measured with a spectrum analyzer at S/I=46dB.

Description of Operation (See Electrical Characteristics Test Circuit.)

(1) VHF oscillator circuit

The differential oscillator circuit with an output at Pin 1 and an input at Pin 16.

Connect an LC resonance circuit comprising a varicap diode to Pin 1 through a coupling capacitor. The positive feedback from the resonance circuit is applied to Pin 16 through a feedback capacitor to execute oscillation. Note that if a parasitic capacitance across Pins 16 and 1 is too large, it may cause undesired oscillation.

(2) VHF mixer circuit

This is a double-balanced mixer having small leakage of local oscillation signal. The RF signal is input to Pins 9 and 10. In normal use, the signal is input to one pin while the other pin is connected to GND by decoupling capacitor. The RF signal is converted to IF with the signal supplied from oscillator. The converted RF is sent to the IF amplifier and output to Pins 13 and 14 simultaneously.

(3) UHF oscillator circuit

UHF oscillator is formed from two collector-grounded Colpitts oscillators, and oscillation is provided at the differential input through an LC resonator circuit including a varicap diode.

The Pin 5 also functions as UHF/VHF switch pin.

(4) UHF mixer circuit

This is the double-balanced mixer like the VHF mixer. The RF signal is input to Pins 7 and 8. There is a balanced differential input from pre-stage double tune circuit, or an unbalanced input to Pin 8 with the capacitor connected at Pin 7 to GND. Balanced input achieves better NF rather than unbalanced input.

Otherwise, the conditions and usage are the same as those for the VHF mixer circuit.

(5) IF amplifier circuit

The mixer output signal is amplified by the IF amplifier and output to Pin 12. The output impedance is about $75\ \Omega$.

(6) UHF/VHF switch circuit

UHF/VHF mode is selected by the DC voltage at Pin 5. UHF operation is chosen by inputting 9V through a $20\text{k}\Omega$ resistor, and VHF operation by inputting 0V. If the UHF switch voltage is 12V not 9V, adjust the resistance to approximately $30\text{k}\Omega$ so that the DC voltage becomes almost equal between Pins 2 and 5. Be sure to connect a resistor for discharging (approx. $10\text{k}\Omega$) if OPEN not 0V is chosen for the VHF switch voltage.

Notes on Usage

Care should be taken such as grounding in placing external parts because high frequencies are present. Adjust accordingly to prevent heat problems with special care such as the GND pattern for heat dissipation at the portion for IC mount where heat dissipations accumulate.

Example of Representative Characteristics

Circuit current vs. Supply voltage

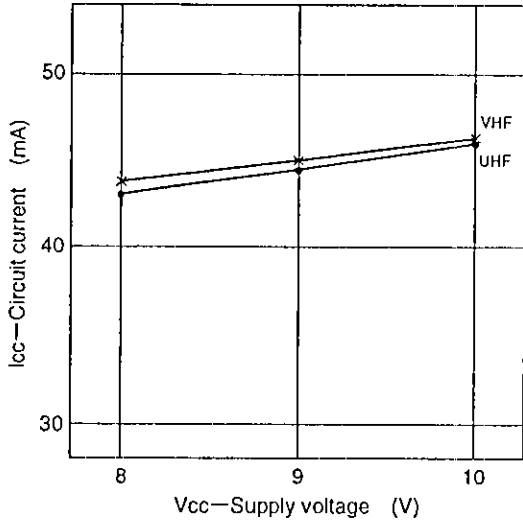

Conversion gain vs. Reception frequency (Untuned input)

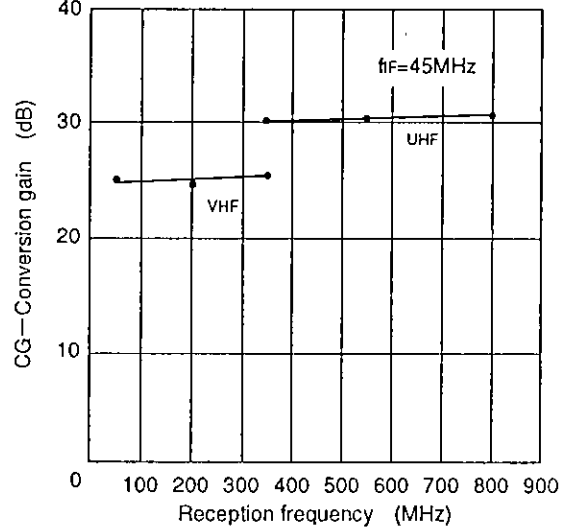

Noise figure vs. Reception frequency (Untuned input, in DSB)

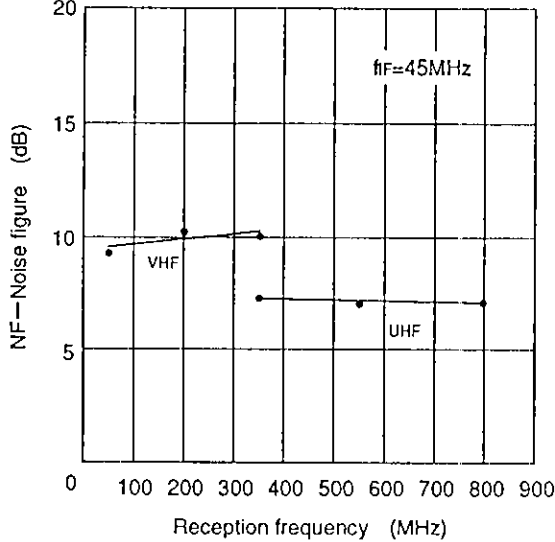

Next adjacent cross modulation vs. Reception frequency (Untuned input)

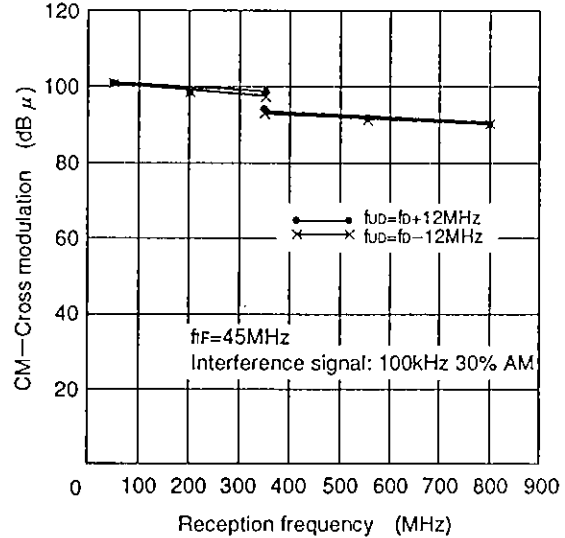

I/O characteristics (Untuned Input)

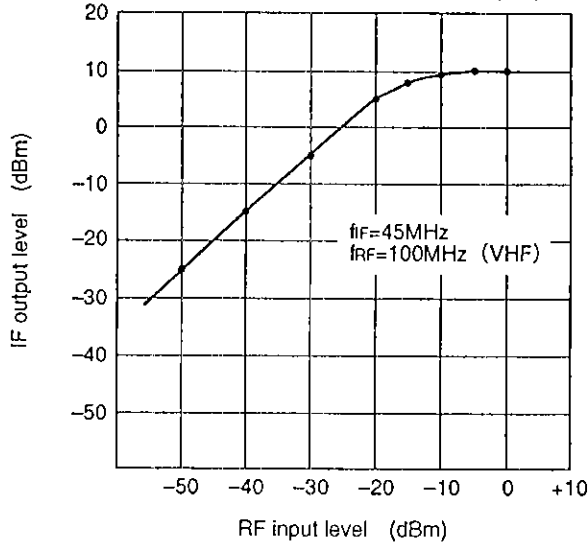

VHF Input Impedance

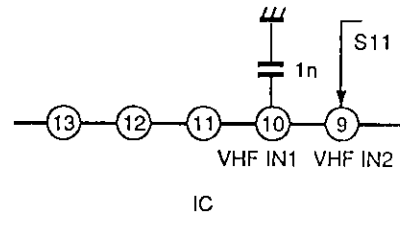
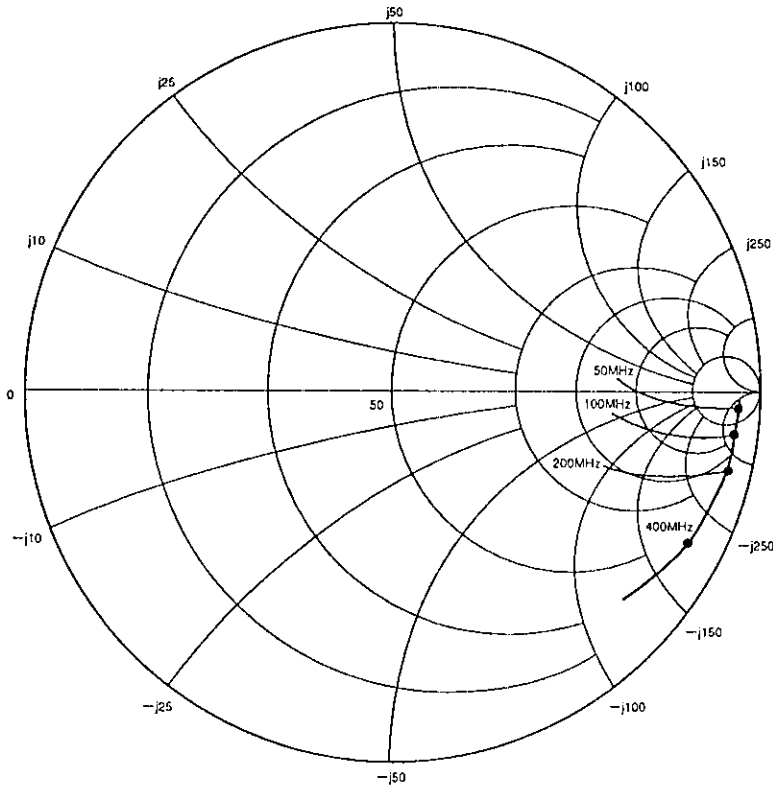

UHF Input Impedance

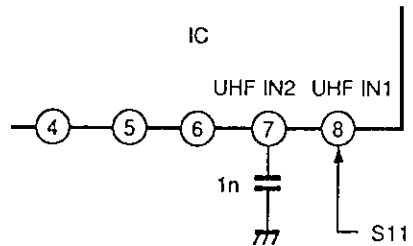
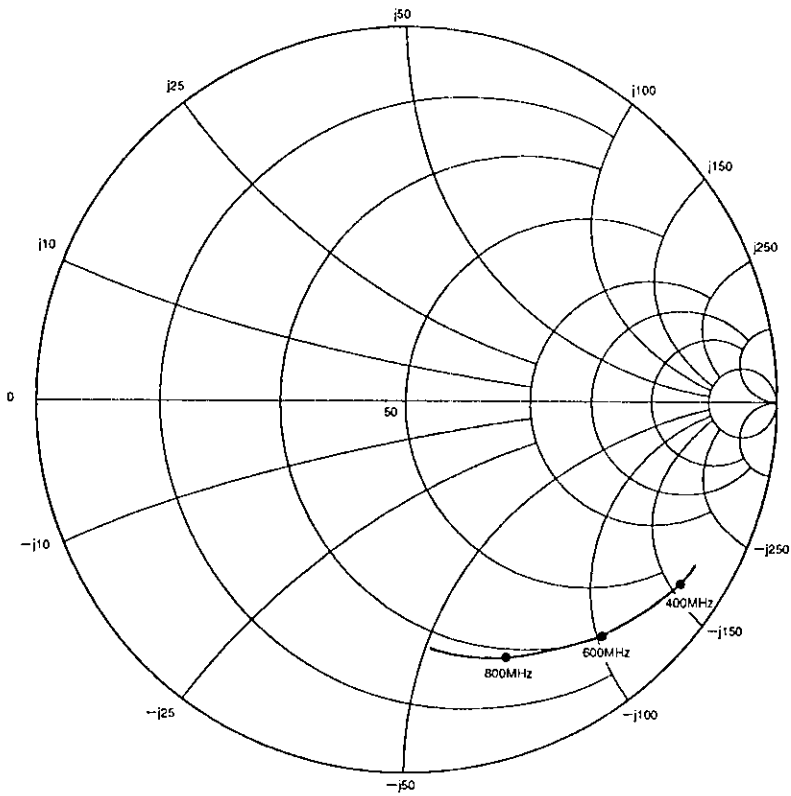

IF Output Impedance

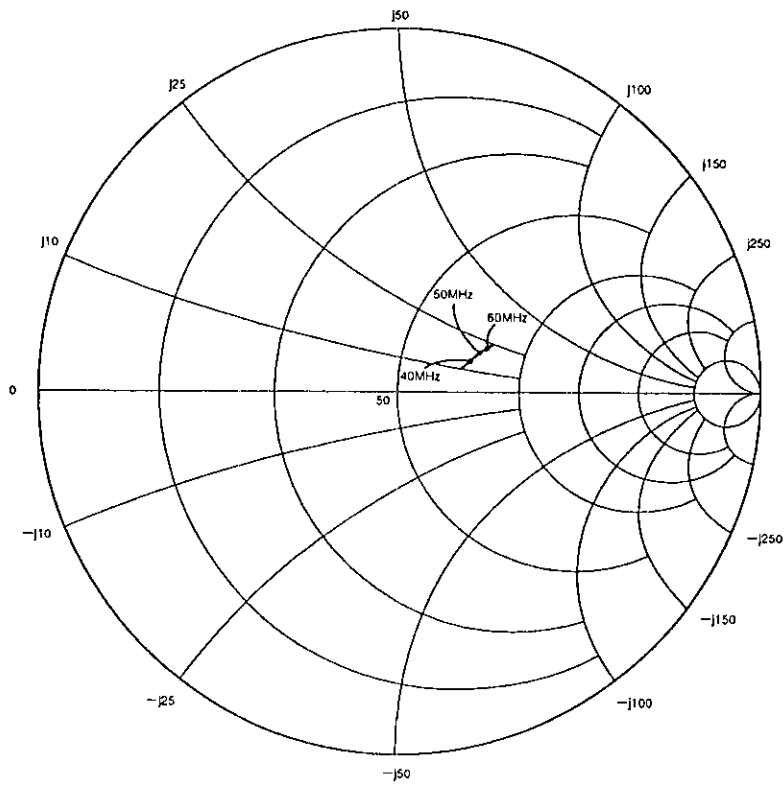

Package Outline Unit: mm

16pin SOP (Plastic) 300mil 0.2g

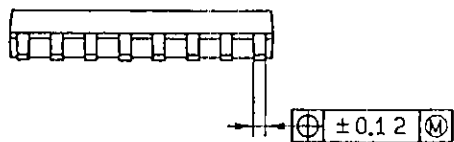
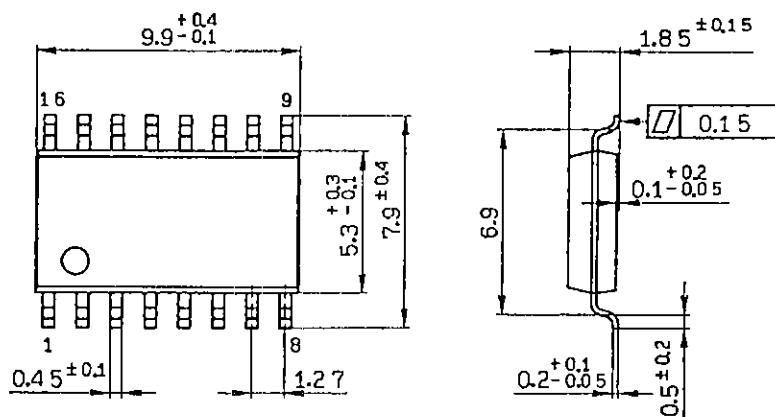

SONY NAME	SOP-16P-L01
EIAJ NAME	*SOP016-P-0300-A
JEDEC CODE	_____



LittleDiode supplies new, hard to find or obsolete electronic components and semiconductors all over the world.

With over two million different components listed you are sure to find the part you need.

Feel free to visit us today at our online store:

LittleDiode.com

Looking forward to providing you with the best possible service.