

**RGB Driver for LCD**

**Description**

The CXA1853AQ is an RGB driver for LCD panels. It supports a line alternative RGB drive system.

**Features**

- Built-in RGB signal phase matching sample-and-hold circuit
- Effective frequency response (18MHz Typ.)
- Built-in gain and breakpoint variable 2-point  $\gamma$  compensation circuit
- Built-in side black generation circuit for 4:3/16:9 aspect conversion
- Built-in VCOM voltage output circuit

**Structure**

Bipolar silicon monolithic IC

**Applications**

- Liquid crystal projectors
- Liquid crystal viewfinders
- Compact liquid crystal monitors

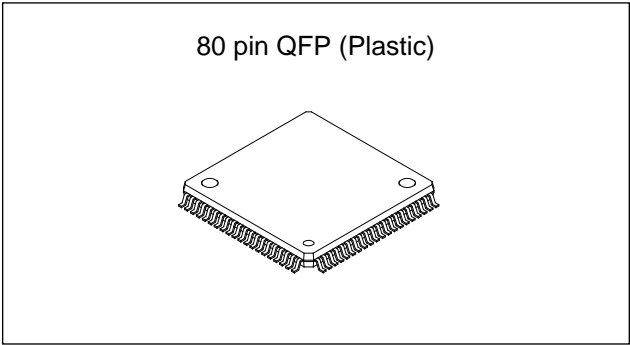

**Absolute Maximum Ratings (Ta = 25°C)**

• Supply voltage	Vcc1	6	V
	Vcc2	15	V
• Input pin voltage	VIN	Vcc1	V
• Operating temperature	Topr	-25 to +75	°C
• Storage temperature	Tstg	-55 to +150	°C
• Allowable power dissipation	PD	1500	mW

**Operating Conditions**

• Supply voltage	Vcc1	4.75 to 5.25	V
	Vcc2	11.0 to 14.0	V
• RGB input signal voltage	VIN	0.7 Vp-p	Note)

**Note)** Defined as the amplitude from the pedestal level to white.

Sony reserves the right to change products and specifications without prior notice. This information does not convey any license by any implication or otherwise under any patents or other right. Application circuits shown, if any, are typical examples illustrating the operation of the devices. Sony cannot assume responsibility for any problems arising out of the use of these circuits.

Block Diagram

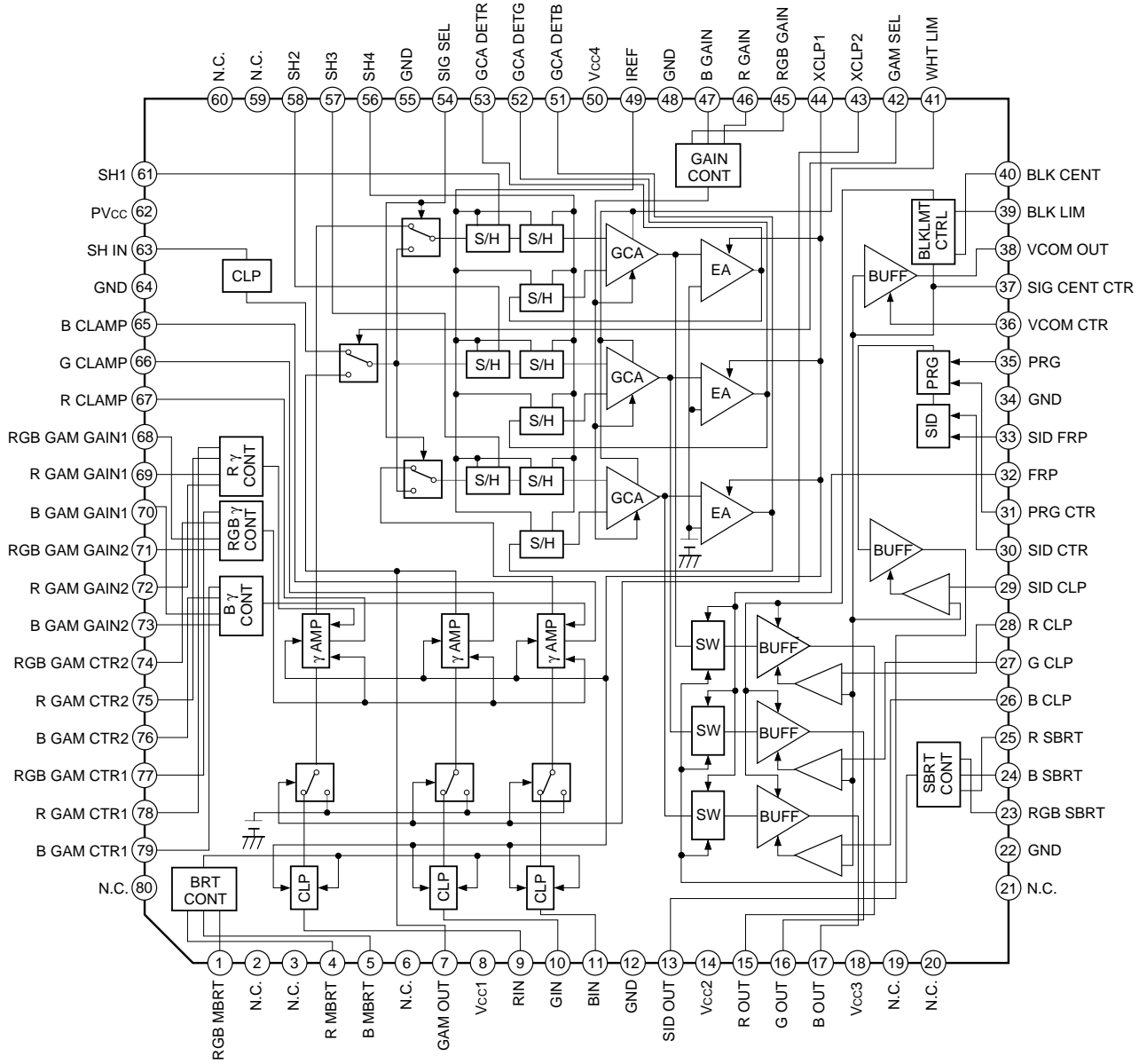

Pin Description

(Vcc1 = 5V, Vcc2 = 13V)

Pin NO.	Symbol	Pin voltage	Equivalent circuit	Description
1	RGB MBRT	1.6 to 5.0V*		RGB signal common main brightness control. Preset internally to 3.3V.
4	R MBRT	1.6 to 5.0V*		R signal main brightness control. Preset internally to 3.3V.
5	B MBRT	1.6 to 5.0V*		B signal main brightness control. Preset internally to 3.3V.
7	GAM OUT	2V 		G signal output of which main bright and gamma are adjusted and insert the reference signal.
8	Vcc1	5V		5V power supply.
9	RIN			R signal input. Input a 0.7Vp-p signal. <sup>Note 2)</sup>
10	GIN			G signal input. Input a 0.7Vp-p signal. <sup>Note 2)</sup>
11	BIN			B signal input. Input a 0.7Vp-p signal. <sup>Note 2)</sup>
12	GND	0V		GND.
13	SID OUT			SID signal output.

**Note 1)** \* in the Pin voltage indicates external applied voltage.

**Note 2)** Defined as the amplitude from the pedestal level to white.

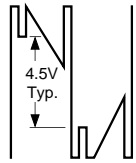
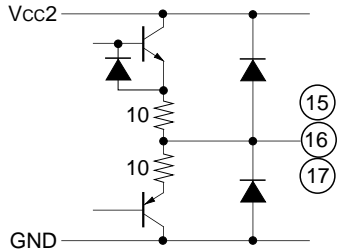
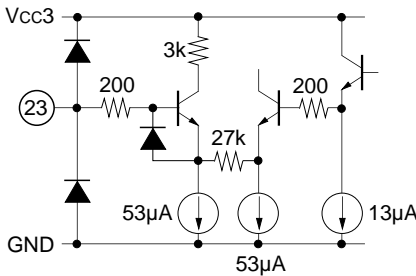
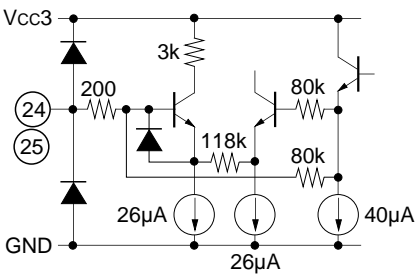
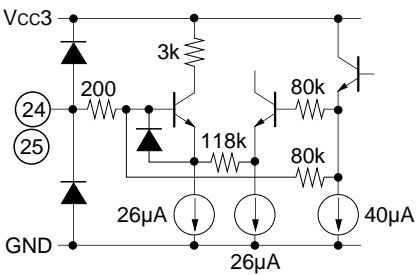
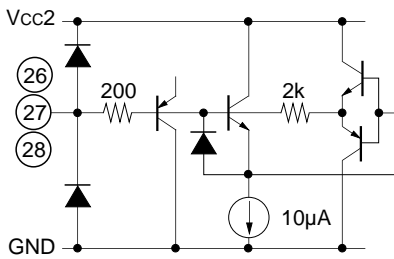
Pin NO.	Symbol	Pin voltage	Equivalent circuit	Description
14	Vcc2	13V		13V power supply.
15	R OUT	 <p>4.5V Typ.</p>		R signal output.
16	G OUT			G signal output.
17	B OUT			B signal output.
18	Vcc3	5V		5V power supply.
22	GND	0V		GND.
23	RGB SBRT	1.6 to 5.0V*		RGB signal common sub brightness control.
24	B SBRT	1.6 to 5.0V*		B signal sub brightness control. Preset internally to 3.3V.
25	R SBRT	1.6 to 5.0V*		R signal sub brightness control. Preset internally to 3.3V.
26	B CLP	4.7 to 8.3V*		B output detection signal input.
27	G CLP			G output detection signal input.
28	R CLP			R output detection signal input.

**Note)** \* in the Pin voltage indicates external applied voltage.

Pin NO.	Symbol	Pin voltage	Equivalent circuit	Description
29	SID CLP	4.7 to 8.3V*		<p>SID output detection signal input. Use an average value detecting external capacitor with a small leak current absolute value and tolerance.</p>
30	SID CTR	1.6 to 5.0V*		<p>SID output amplitude control. Preset internally to 3.3V.</p>
31	PRG CTR	1.6 to 5.0V*		<p>Level control for the PRG signal inserted into the SID signal.</p>
32	FRP			<p>FRP input. This pulse is used to invert the polarity of the RGB output. Output is inverted when Low, and non-inverted when High. Input level: High <math>\geq</math> 4V Low <math>\leq</math> 1V</p>
33	SID FRP			<p>FRP pulse input for SID output. This pulse is used to invert the polarity of the SID output. Output is inverted when Low, and non-inverted when High. Input level: High <math>\geq</math> 4V Low <math>\leq</math> 1V</p>
34	GND	0V		GND.

Note) \* in the Pin voltage indicates external applied voltage.

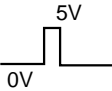
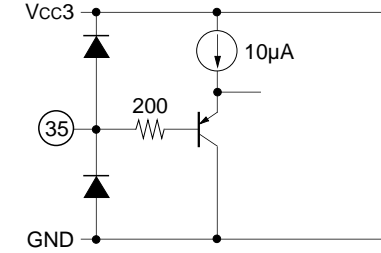
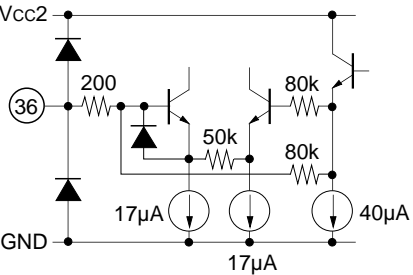
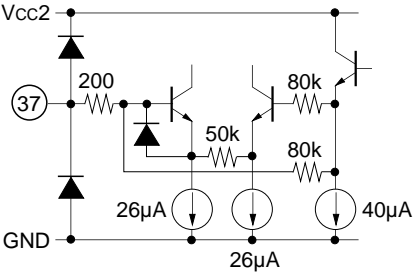
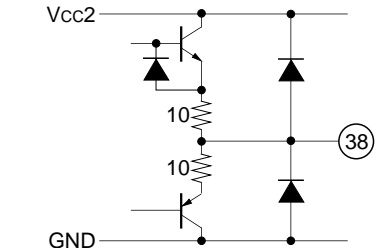
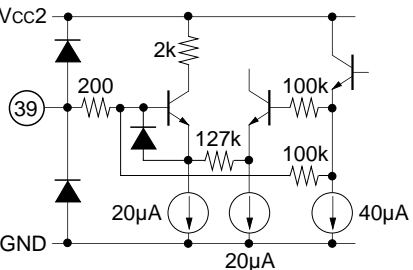
Pin NO.	Symbol	Pin voltage	Equivalent circuit	Description
35	PRG			PRG pulse input. This pulse is used to insert the PRG signal into the SID output. Input level: High $\geq 4V$ Low $\leq 1V$
36	VCOM CTR	1.6 to 5.0V*		VCOM voltage control. The VCOM voltage variable range is $-0.8V$ to $+1.3V$ with respect to the signal center voltage.
37	SIG CENT CTR	1.6 to 5.0V*		RGB and SID signal center voltage control.
38	VCOM OUT	3.4 to 9.1V*		VCOM voltage output.
39	BLK LIM	1.6 to 5.0V*		Limiter control for limiting the output amplitude of the RGB signal. Preset internally to 3.3V.

**Note)** \* in the Pin voltage indicates external applied voltage.

Pin NO.	Symbol	Pin voltage	Equivalent circuit	Description
40	BLK CENT	1.6 to 5.0V*		<p>RGB signal output limiter center control. Preset internally to 3.3V. When preset, the limiter center becomes equal to the RGB output center.</p>
41	WHT LIM	1.6 to 5.0V*		<p>RGB signal white peak limiter control. Preset internally to 3.3V.</p>
42	GAM SEL	5.0V*		<p>Gamma circuit control. Gamma ON when High, gamma OFF when Low. Input level: High <math>\geq</math> 4V Low <math>\leq</math> 1V</p>
43	XCLP2			<p>Reference signal pulse input. Reference level when Low. Input level: High <math>\geq</math> 4V Low <math>\leq</math> 1V</p>
44	XCLP1			<p>Clamp pulse input. Clamped when Low. Input level: High <math>\geq</math> 4V Low <math>\leq</math> 1V</p>
45	RGB GAIN	1.6 to 5.0V*		<p>Gain control for RGB signal common variable gain amplifier.</p>

Note) \* in the Pin voltage indicates external applied voltage.

Pin NO.	Symbol	Pin voltage	Equivalent circuit	Description
46	R GAIN	1.6 to 5.0V*		Gain control for R signal variable gain amplifier. Preset internally to 3.3V.
47	B GAIN	1.6 to 5.0V*		Gain control for B signal variable gain amplifier. Preset internally to 3.3V.
48	GND	0V		GND.
49	IREF	1.2V		Sample-and -hold circuit current setting.
50	Vcc4	5.0V		5V power supply.
51	GCADET B	1.8V Typ.		B GCA circuit clamp detection.
52	GCADET G			G GCA circuit clamp detection.
53	GCADET R			R GCA circuit clamp detection.
54	SIG SEL	0 to 5.0V*		Selection of input signal to Sample-and -hold circuit. R and B signals selected when High, G signal selected when Low. Input level: High $\geq$ 4V Low $\leq$ 1V
55	GND	0V		GND.
56	SH4			Sample-and-hold pulse input. Input level: High $\geq$ 3.0V Low $\leq$ 1.0V Sampling when High, hold when Low.
57	SH3			
58	SH2			
61	SH1			
62	PVcc	5V		5V power supply.

Note) \* in the Pin voltage indicates external applied voltage.

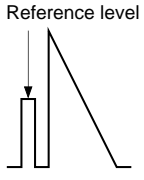
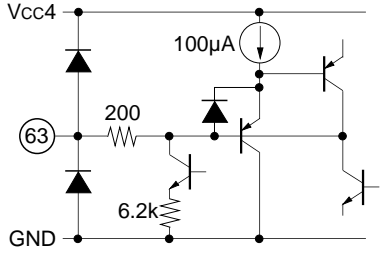
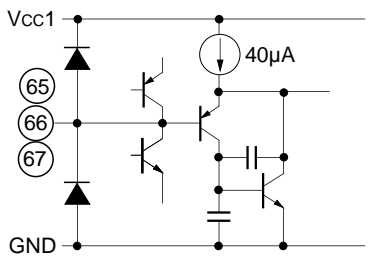
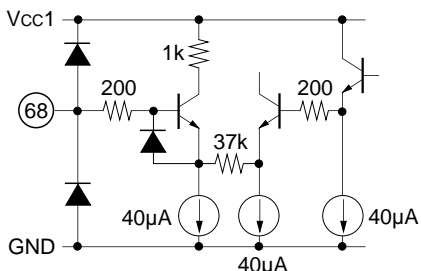
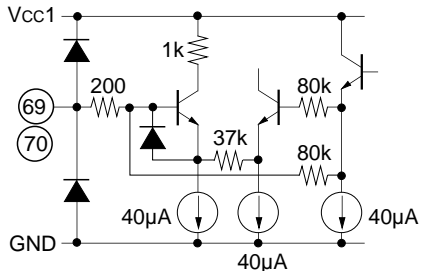
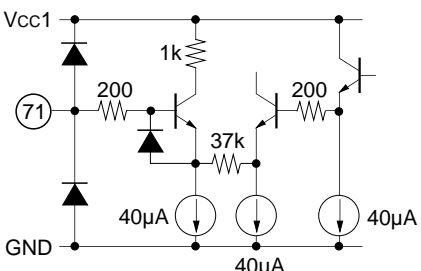
Pin NO.	Symbol	Pin voltage	Equivalent circuit	Description
63	SH IN	2.25V 		Sample-and-hold circuit input.
64	GND	0V		GND.
65	B CLAMP	2.1V Typ.		B signal clamp detection.
66	G CLAMP			G signal clamp detection.
67	R CLAMP			R signal clamp detection.
68	RGB GAM GAIN 1	1.6 to 5.0V*		RGB signal common black side voltage gain control.
69	R GAM GAIN 1	1.6 to 5.0V*		R signal black side voltage gain control. Preset internally to 3.3V.
70	B GAM GAIN 1	1.6 to 5.0V*		B signal black side voltage gain control. Preset internally to 3.3V.
71	RGB GAM GAIN 2	1.6 to 5.0V*		RGB signal common white side voltage gain control.

**Note)** \* in the Pin voltage indicates external applied voltage.

Pin NO.	Symbol	Pin voltage	Equivalent circuit	Description
72	R GAM GAIN 2	1.6 to 5.0V*		R signal white side voltage gain control. Preset internally to 3.3V.
73	B GAM GAIN 2	1.6 to 5.0V*		B signal white side voltage gain control. Preset internally to 3.3V.
74	RGB GAM CTR 2	1.6 to 5.0V*		RGB signal common white side voltage gain change point control.
75	R GAM CTR 2	1.6 to 5.0V*		R signal white side voltage gain change point control. Preset internally to 3.3V.
76	B GAM CTR 2	1.6 to 5.0V*		B signal white side voltage gain change point control. Preset internally to 3.3V.
77	RGB GAM CTR 1	1.6 to 5.0V*		RGB signal common black side voltage gain change point control.
78	R GAM CTR 1	1.6 to 5.0V*		R signal black side voltage gain change point control. Preset internally to 3.3V.
79	B GAM CTR 1	1.6 to 5.0V*		B signal black side voltage gain change point control. Preset internally to 3.3V.

**Note)** \* in the Pin voltage indicates external applied voltage.

## Electrical Characteristics

Unless otherwise specified: Ta = 25°C, Vcc1 = Vcc3 = Vcc4 = PVcc = 5V, Vcc2 = 13V

SW1 = OFF, SW4 = OFF, SW5 = OFF, SW9 = a, SW10 = a, SW11 = a,  
 SW24 = OFF, SW25 = OFF, SW26 = a, SW27 = a, SW28 = a, SW29 = a,  
 SW30 = OFF, SW36 = OFF, SW37 = OFF, SW39 = OFF, SW40 = OFF,  
 SW41 = OFF, SW46 = OFF, SW47 = OFF, SW51 = a, SW52 = a,  
 SW53 = a, SW63 = a, SW65 = a, SW66 = a, SW67 = a, SW69 = OFF,  
 SW70 = OFF, SW72 = OFF, SW73 = OFF, SW75 = OFF, SW76 = OFF,  
 SW78 = OFF, SW79 = OFF, V23 = 3.1V, V31 = 3.5V, V42 = 5.0V,  
 V45 = 2.8V, V54 = 5.0V, V68 = 1.6V, V71 = 1.6V, V74 = 1.6V, V77 = 5.0V

Set (R IN), (G IN), (B IN) and (TEST IN) = 0V, (SH1), (SH2), (SH3) and  
 (SH4) = 5V, and input SG4 to (FRP) and (SID FRP), SG5 to (PRG),  
 SG2 to (XCLP2) and SG3 to (XCLP1).

No.	Item	Symbol	Measurement conditions	Min.	Typ.	Max.	Unit
1	Current consumption (1)	Icc1	Measure the current entering Pin 8.	—	30	44	mA
2	Current consumption (2)	Icc2	Measure the current entering Pin 14.	—	11	18	mA
3	Current consumption (3)	Icc3	Measure the current entering Pin 18.	—	6	10	mA
4	Current consumption (4)	Icc4	Measure the current entering Pin 50.	—	29	43	mA
5	Current consumption (5)	Icc5	Measure the current entering Pin 62.	—	4	7	mA
6	R IN pin current "Z"	Iz9	SW9 → b, (XCLP1) = 5V, V9 = 2.4V	-1.5	0	1.5	μA
7	R IN pin current "H"	Ih9	SW9 → b, (XCLP1) = 0V, V9 = 3.4V	13	25	—	μA
8	R IN pin current "L"	Il9	SW9 → b, (XCLP1) = 0V, V9 = 1.4V	—	-25	-13	μA
9	G IN pin current "Z"	Iz10	SW10 → b, (XCLP1) = 5V, V10 = 2.4V	-1.5	0	1.5	μA
10	G IN pin current "H"	Ih10	SW10 → b, (XCLP1) = 0V, V10 = 3.4V	13	25	—	μA
11	G IN pin current "L"	Il10	SW10 → b, (XCLP1) = 0V, V10 = 1.4V	—	-25	-13	μA
12	B IN pin current "Z"	Iz11	SW11 → b, (XCLP1) = 5V, V11 = 2.4V	-1.5	0	1.5	μA
13	B IN pin current "H"	Ih11	SW11 → b, (XCLP1) = 0V, V11 = 3.4V	13	25	—	μA
14	B IN pin current "L"	Il11	SW11 → b, (XCLP1) = 0V, V11 = 1.4V	—	-25	-13	μA
15	RGB SBRT pin current	I23	V23 = 5.0V	—	2.5	6	μA
16	B CLP pin current	I26	SW26 → b, V26 = 7.0V	-0.2	0	0.2	μA
17	G CLP pin current	I27	SW27 → b, V27 = 7.0V	-0.2	0	0.2	μA
18	R CLP pin current	I28	SW28 → b, V28 = 7.0V	-0.2	0	0.2	μA
19	SID CLP pin current	I29	SW29 → b, V29 = 7.0V	-0.2	0	0.2	μA
20	PRG CTR pin current	I31	V31 = 5.0V	—	0.3	0.8	μA
21	FRP pin current "H"	Ih32	(FRP) = 5V	-0.1	0	0.1	μA
22	FRP pin current "L"	Il32	(FRP) = 0V	-0.3	-0.1	—	μA
23	SID FRP pin current "H"	Ih33	(SID FRP) = 5V	-0.1	0	0.1	μA
24	SID FRP pin current "L"	Il33	(SID FRP) = 0V	-0.3	-0.1	—	μA
25	PRG pin current "H"	Ih35	(PRG) = 5V	-0.1	0	0.1	μA
26	PRG pin current "L"	Il35	(PRG) = 0V	-0.3	-0.1	—	μA
27	GAM SEL pin current "H"	Ih42	V42 = 5V	-0.1	0	0.1	μA

No.	Item	Symbol	Measurement conditions	Min.	Typ.	Max.	Unit
28	GAM SEL pin current "L"	IL42	V42 = 0V	—	-1.7	-0.4	μA
29	XCLP2 pin current "H"	IH43	(XCLP2) = 5V	-0.1	0	0.1	μA
30	XCLP2 pin current "L"	IL43	(XCLP2) = 0V	—	-1.0	-0.3	μA
31	XCLP1 pin current "H"	IH44	(XCLP1) = 5V	-0.1	0	0.1	μA
32	XCLP1 pin current "L"	IL44	(XCLP1) = 0V	-1.0	-0.2	—	μA
33	RGB GAIN pin current	I45	V45 = 5V	—	0.5	1.3	μA
34	GCA DET B pin current "Z"	IZ51	SW51 → b, (XCLP1) = 5V, V51 = 2.0V	-0.5	0	0.5	μA
35	GCA DET B pin current "H"	IH51	SW51 → b, (XCLP1) = 0V, V51 = 3.0V	15	30	—	μA
36	GCA DET B pin current "L"	IL51	SW51 → b, (XCLP1) = 0V, V51 = 1.0V	—	30	-15	μA
37	GCA DET G pin current "Z"	IZ52	SW52 → b, (XCLP1) = 5V, V52 = 2.0V	-0.5	0	0.5	μA
38	GCA DET G pin current "H"	IH52	SW52 → b, (XCLP1) = 5V, V52 = 3.0V	15	30	—	μA
39	GCA DET G pin current "L"	IL52	SW52 → b, (XCLP1) = 5V, V52 = 1.0V	—	-30	-15	μA
40	GCA DET R pin current "Z"	IZ53	SW53 → b, (XCLP1) = 5V, V53 = 2.0V	-0.5	0	0.5	μA
41	GCA DET R pin current "H"	IH53	SW53 → b, (XCLP1) = 5V, V53 = 3.0V	15	30	—	μA
42	GCA DET R pin current "L"	IL53	SW53 → b, (XCLP1) = 5V, V53 = 1.0V	—	-30	-15	μA
43	SIG SEL pin current "H"	I54H	V54 = 5V	-0.1	0	0.1	μA
44	SIG SEL pin current "L"	I54L	V54 = 0V	-3.0	-1.0	—	μA
45	SH4 pin current "H"	I56H	(SH4) = 5V	-0.1	0	0.1	μA
46	SH4 pin current "L"	I56L	(SH4) = 0V	-5.0	-2.0	—	μA
47	SH3 pin current "H"	I57H	(SH3) = 5V	-0.1	0	0.1	μA
48	SH3 pin current "L"	I57L	(SH3) = 0V	-5.0	-2.0	—	μA
49	SH2 pin current "H"	I58H	(SH2) = 5V	-0.1	0	0.1	μA
50	SH2 pin current "L"	I58L	(SH2) = 0V	-5.0	-2.0	—	μA
51	SH1 pin current "H"	I61H	(SH1) = 5V	-0.1	0	0.1	μA
52	SH1 pin current "L"	I61L	(SH1) = 0V	-5.0	-2.0	—	μA
53	SH IN pin current "Z"	IZ63	SW63 → b, (XCLP1) = 5V, V63 = 2.2V	-1.5	0	1.5	μA
54	SH IN pin current "H"	IH63	SW63 → b, (XCLP1) = 0V, V63 = 3.2V	13	25	—	μA
55	SH IN pin current "L"	IL63	SW63 → b, (XCLP1) = 0V, V63 = 1.2V	—	-25	-13	μA
56	B CLAMP pin current "Z"	IZ65	SW65 → b, (XCLP1) = 5V, V65 = 2.0V	-0.5	0	0.5	μA
57	B CLAMP pin current "H"	IH65	SW65 → b, (XCLP1) = 0V, V65 = 3.0V	15	40	—	μA
58	B CLAMP pin current "L"	IL65	SW65 → b, (XCLP1) = 0V, V65 = 1.0V	—	-40	-15	μA
59	G CLAMP pin current "Z"	IZ66	SW66 → b, (XCLP1) = 5V, V66 = 2.0V	-0.5	0	0.5	μA
60	G CLAMP pin current "H"	IH66	SW66 → b, (XCLP1) = 0V, V66 = 3.0V	15	40	—	μA
61	G CLAMP pin current "L"	IL66	SW66 → b, (XCLP1) = 0V, V66 = 1.0V	—	-40	-15	μA
62	R CLAMP pin current "Z"	IZ67	SW67 → b, (XCLP1) = 5V, V67 = 2.0V	-0.5	0	0.5	μA
63	R CLAMP pin current "H"	IH67	SW67 → b, (XCLP1) = 0V, V67 = 3.0V	15	40	—	μA
64	R CLAMP pin current "L"	IL67	SW67 → b, (XCLP1) = 0V, V67 = 1.0V	—	-40	-15	μA
65	RGB GAM GAIN1 pin current	I68	V68 = 5.0V	—	0.5	1.3	μA

No.	Item	Symbol	Measurement conditions	Min.	Typ.	Max.	Unit
66	RGB GAM GAIN2 pin current	I71	V71 = 5.0V	—	0.5	1.3	μA
67	RGB GAM CTR2 pin current	I74	V74 = 5.0V	—	0.5	1.3	μA
68	RGB GAM CTR1 pin current	I77	V77 = 5.0V	—	0.5	1.3	μA
69	RIN pin voltage	V9		1.3	1.7	2.1	V
70	GIN pin voltage	V10		1.3	1.7	2.1	V
71	BIN pin voltage	V11		1.3	1.7	2.1	V
72	B SBRT pin voltage	V24		2.9	3.3	3.7	V
73	R SBRT pin voltage	V25		2.9	3.3	3.7	V
74	SID CTR pin voltage	V30		2.9	3.3	3.7	V
75	VCOM CTR pin voltage	V36		2.9	3.3	3.7	V
76	SIG CENT CTR pin voltage	V37		2.9	3.3	3.7	V
77	BLK LIM pin voltage	V39		2.9	3.3	3.7	V
78	BLK CENT pin voltage	V40		2.9	3.3	3.7	V
79	WHT LIM pin voltage	V41		2.9	3.3	3.7	V
80	R GAIN pin voltage	V46		2.9	3.3	3.7	V
81	B GAIN pin voltage	V47		2.9	3.3	3.7	V
82	IREF pin voltage	V49		0.8	1.2	1.6	V
83	GCA DET B pin voltage	V51		1.2	1.8	2.4	V
84	GCA DET G pin voltage	V52		1.2	1.8	2.4	V
85	GCA DET R pin voltage	V53		1.2	1.8	2.4	V
86	SH IN pin voltage	V63		1.9	2.3	2.7	V
87	B CLAMP pin voltage	V65		1.6	2.1	2.6	V
88	G CLAMP pin voltage	V66		1.6	2.1	2.6	V
89	R CLAMP pin voltage	V67		1.6	2.1	2.6	V
90	R GAM GAIN1 pin voltage	V69		2.9	3.3	3.7	V
91	B GAM GAIN1 pin voltage	V70		2.9	3.3	3.7	V
92	R GAM GAIN2 pin voltage	V72		2.9	3.3	3.7	V
93	B GAM GAIN2 pin voltage	V73		2.9	3.3	3.7	V
94	R GAM CTR2 pin voltage	V75		2.9	3.3	3.7	V
95	B GAM CTR2 pin voltage	V76		2.9	3.3	3.7	V
96	R GAM CTR1 pin voltage	V78		2.9	3.3	3.7	V
97	B GAM CTR1 pin voltage	V79		2.9	3.3	3.7	V
98	RGB MBRT pin voltage	V1		2.9	3.3	3.7	V
99	R MBRT pin voltage	V4		2.9	3.3	3.7	V
100	B MBRT pin voltage	V5		2.9	3.3	3.7	V
101	RGB MBRT input impedance	Z1		45	80	110	kΩ

No.	Item	Symbol	Measurement conditions	Min.	Typ.	Max.	Unit
102	R MBRT input impedance	Z4		45	80	110	k $\Omega$
103	B MBRT input impedance	Z5		45	80	110	k $\Omega$
104	B SBRT input impedance	Z24		45	80	110	k $\Omega$
105	R SBRT input impedance	Z25		45	80	110	k $\Omega$
106	SID CTR input impedance	Z30		45	80	110	k $\Omega$
107	VCOM CTR input impedance	Z36		45	80	110	k $\Omega$
108	SIG CENT CTR input impedance	Z37		45	80	110	k $\Omega$
109	BLK LIM input impedance	Z39		55	100	150	k $\Omega$
110	BLK CENT input impedance	Z40		55	100	150	k $\Omega$
111	WHT LIM input impedance	Z41		55	100	150	k $\Omega$
112	R GAIN input impedance	Z46		45	80	110	k $\Omega$
113	B GAIN input impedance	Z47		45	80	110	k $\Omega$
114	R GAM GAIN1 input impedance	Z69		45	80	110	k $\Omega$
115	B GAM GAIN1 input impedance	Z70		45	80	110	k $\Omega$
116	R GAM GAIN2 input impedance	Z72		45	80	110	k $\Omega$
117	B GAM GAIN2 input impedance	Z73		45	80	110	k $\Omega$
118	R GAM CTR2 input impedance	Z75		45	80	110	k $\Omega$
119	B GAM CTR2 input impedance	Z76		45	80	110	k $\Omega$
120	R GAM CTR1 input impedance	Z78		45	80	110	k $\Omega$
121	B GAM CTR1 input impedance	Z79		45	80	110	k $\Omega$

No.	Item	Symbol	Measurement conditions	Min.	Typ.	Max.	Unit
122	RGB GAIN adjustment range (1)	$\Delta G_{CS1}$	Set SW41 → ON, V41 = 1.6V, V42 = 0V, V54 = 0V and input SG1 (0 dB) to (TEST IN). Then adjust V45 so that the non-inverted output amplitude (black to white) at TP16 is 5 times the input signal amplitude and label this as $V_i$ . Input SG1 (–6 dB) to (TEST IN) and label the non-inverted output amplitudes (black to white) at TP15, TP16 and TP17 with V45 = $V_i$ as $V_{RST}$ , $V_{GST}$ and $V_{BST}$ , and the inverted output amplitudes as $V_{RSTA}$ , $V_{GSTA}$ and $V_{BSTA}$ , respectively. Next, label the non-inverted output amplitudes (black to white) at TP15, TP16 and TP17 with V45 = 5.0V as $V_{RSM}$ , $V_{GSM}$ and $V_{BSM}$ , and the inverted output amplitudes as $V_{RSMA}$ , $V_{GSMA}$ and $V_{BSMA}$ , respectively. Next, label the non-inverted output amplitudes (black to white) at TP15, TP16 and TP17 with V45 = 1.6V as $V_{RSN}$ , $V_{GSN}$ and $V_{BSN}$ , and the inverted output amplitudes as $V_{RSNA}$ , $V_{GSNA}$ and $V_{BSNA}$ , respectively. $\Delta G_{CS1} = 20\log(V_{RSM(A)}/V_{RST(A)})$ $= 20\log(V_{GSM(A)}/V_{GST(A)})$ $= 20\log(V_{BSM(A)}/V_{BST(A)})$ $\Delta G_{CS2} = 20\log(V_{RSN(A)}/V_{RST(A)})$ $= 20\log(V_{GSN(A)}/V_{GST(A)})$ $= 20\log(V_{BSN(A)}/V_{BST(A)})$	4.0	6.0	—	dB
123	RGB GAIN adjustment range (2)	$\Delta G_{CS2}$	Set V42 = 0V, V54 = 0V, input SG1 (–6dB) to (TEST IN), and set V45 = $V_i$ , SW46 → ON, SW41 → ON, V41 = 1.6V and V46 = 5.0V. Then label the non-inverted output amplitude (black to white) at TP15 as $V_{RSTM}$ and the inverted output amplitude as $V_{RSTMA}$ . Next, label the non-inverted output amplitude (black to white) at TP15 with V46 = 1.6V as $V_{RSTN}$ and the inverted output amplitude as $V_{RSTNA}$ . $\Delta G_{RS1} = 20\log(V_{RSTM(A)}/V_{GST(A)})$ $\Delta G_{RS2} = 20\log(V_{RSTN(A)}/V_{GST(A)})$	—	–6.0	–4.0	dB
124	R GAIN adjustment range (1)	$\Delta G_{RS1}$	Set V42 = 0V, V54 = 0V, input SG1 (–6dB) to (TEST IN), and set V45 = $V_i$ , SW47 → ON, SW41 → ON, V41 = 1.6V and V47 = 5.0V. Then label the non-inverted output amplitude (black to white) at TP17 as $V_{BSTM}$ and the inverted output amplitude as $V_{BSTMA}$ . Next, label the non-inverted output amplitude (black to white) at TP17 with V47 = 1.6V as $V_{BSTN}$ and the inverted output amplitude as $V_{BSTNA}$ . $\Delta G_{BS1} = 20\log(V_{BSTM(A)}/V_{GST(A)})$ $\Delta G_{BS2} = 20\log(V_{BSTN(A)}/V_{GST(A)})$	2.5	4.6	—	dB
125	R GAIN adjustment range (2)	$\Delta G_{RS2}$	Set V42 = 0V, V54 = 0V, input SG1 (–6dB) to (TEST IN), and set V45 = $V_i$ , SW47 → ON, SW41 → ON, V41 = 1.6V and V47 = 5.0V. Then label the non-inverted output amplitude (black to white) at TP17 as $V_{BSTM}$ and the inverted output amplitude as $V_{BSTMA}$ . Next, label the non-inverted output amplitude (black to white) at TP17 with V47 = 1.6V as $V_{BSTN}$ and the inverted output amplitude as $V_{BSTNA}$ . $\Delta G_{BS1} = 20\log(V_{BSTM(A)}/V_{GST(A)})$ $\Delta G_{BS2} = 20\log(V_{BSTN(A)}/V_{GST(A)})$	—	–4.6	–2.5	dB
126	B GAIN adjustment range (1)	$\Delta G_{BS1}$	Set V42 = 0V, V54 = 0V, input SG1 (–6dB) to (TEST IN), and set V45 = $V_i$ , SW47 → ON, SW41 → ON, V41 = 1.6V and V47 = 5.0V. Then label the non-inverted output amplitude (black to white) at TP17 as $V_{BSTM}$ and the inverted output amplitude as $V_{BSTMA}$ . Next, label the non-inverted output amplitude (black to white) at TP17 with V47 = 1.6V as $V_{BSTN}$ and the inverted output amplitude as $V_{BSTNA}$ . $\Delta G_{BS1} = 20\log(V_{BSTM(A)}/V_{GST(A)})$ $\Delta G_{BS2} = 20\log(V_{BSTN(A)}/V_{GST(A)})$	2.5	4.6	—	dB
127	B GAIN adjustment range (2)	$\Delta G_{BS2}$	Set V42 = 0V, V54 = 0V, input SG1 (–6dB) to (TEST IN), and set V45 = $V_i$ , SW47 → ON, SW41 → ON, V41 = 1.6V and V47 = 5.0V. Then label the non-inverted output amplitude (black to white) at TP17 as $V_{BSTM}$ and the inverted output amplitude as $V_{BSTMA}$ . Next, label the non-inverted output amplitude (black to white) at TP17 with V47 = 1.6V as $V_{BSTN}$ and the inverted output amplitude as $V_{BSTNA}$ . $\Delta G_{BS1} = 20\log(V_{BSTM(A)}/V_{GST(A)})$ $\Delta G_{BS2} = 20\log(V_{BSTN(A)}/V_{GST(A)})$	—	–4.6	–2.5	dB

No.	Item	Symbol	Measurement conditions	Min.	Typ.	Max.	Unit
128	RGB MBRT adjustment range (1)	$\Delta V_{BM1}$	Label the DC potentials at TP9, TP10 and TP11 as $V_{RT}$ , $V_{GT}$ and $V_{BT}$ , respectively. Next, label the DC potentials at TP9, TP10 and TP11 with SW1 → ON and $V_1 = 5.0V$ as $V_{RN}$ , $V_{GN}$ and $V_{BN}$ , respectively. Next, label the DC potentials at TP9, TP10 and TP11 with $V_1 = 1.6V$ as $V_{RM}$ , $V_{GM}$ and $V_{BM}$ , respectively.	—	-0.35	-0.30	V
129	RGB MBRT adjustment range (2)	$\Delta V_{BM2}$	$\Delta V_{BM1} = V_{RN} - V_{RT}, V_{GN} - V_{GT}, V_{BN} - V_{BT}$ $\Delta V_{BM2} = V_{RM} - V_{RT}, V_{GM} - V_{GT}, V_{BM} - V_{BT}$	0.30	0.35	—	V
130	R MBRT adjustment range (1)	$\Delta V_{BR1}$	Label the DC potential at TP9 with SW4 → ON and $V_4 = 5.0V$ as $V_{RTN}$ . Next, label the DC potential at TP9 with $V_4 = 1.6V$ as $V_{RTM}$ .	—	-0.16	-0.12	V
131	R MBRT adjustment range (2)	$\Delta V_{BR2}$	$\Delta V_{BR1} = V_{RTN} - V_{GT}$ $\Delta V_{BR2} = V_{RTM} - V_{GT}$	0.12	0.16	—	V
132	B MBRT adjustment range (1)	$\Delta V_{BB1}$	Label the DC potential at TP11 with SW5 → ON and $V_5 = 5.0V$ as $V_{BTN}$ . Next, label the DC potential at TP11 with $V_5 = 1.6V$ as $V_{BTM}$ .	—	-0.16	-0.12	V
133	B MBRT adjustment range (2)	$\Delta V_{BB2}$	$\Delta V_{BB1} = V_{BTN} - V_{GT}$ $\Delta V_{BB2} = V_{BTM} - V_{GT}$	0.12	0.16	—	V
134	Maximum RGB output amplitude	$\Delta V_{BMAX}$	Set SW39 → ON, $V_{39} = 1.6V$ , $V_{45} = 5.0V$ and $V_{23} = 5.0V$ . Then measure the amplitudes (black to black) at TP15, TP16 and TP17.	10.0	10.7	—	Vp-p
135	RGB SBRT adjustment range (1)	$V_{SBN}$	Set SW39 → ON and $V_{39} = 1.6V$ . Then label the non-inverted reference level potentials at TP15, TP16 and TP17 as $V_{SRT}$ , $V_{SGT}$ and $V_{SBT}$ , and the inverted reference level potentials as $V_{SRTA}$ , $V_{SGTA}$ and $V_{SBTA}$ , respectively. Next, label the non-inverted reference level potentials at TP15, TP16 and TP17 with $V_{23} = 1.6V$ as $V_{SRN}$ , $V_{SGN}$ and $V_{SBN}$ , and the inverted reference level potentials as $V_{SRNA}$ , $V_{SGNA}$ and $V_{SBNA}$ , respectively.	—	-0.7	0	V
136	RGB SBRT adjustment range (2)	$V_{SBM}$	Next, label the non-inverted reference level potentials at TP15, TP16 and TP17 with $V_{23} = 5.0V$ as $V_{SRM}$ , $V_{SGM}$ and $V_{SBM}$ , and the inverted reference level potentials as $V_{SRMA}$ , $V_{SGMA}$ and $V_{SBMA}$ , respectively. $V_{SBN} = V_{SRNA} - V_{SRN}, V_{SGNA} - V_{SGN}, V_{SBNA} - V_{SBN}$ $V_{SBM} = V_{SRMA} - V_{SRM}, V_{SGMA} - V_{SGM}, V_{SBMA} - V_{SBM}$	8.5	10.7	—	V

No.	Item	Symbol	Measurement conditions	Min.	Typ.	Max.	Unit
137	R SBRT adjustment range (1)	$\Delta V_{SSR1}$	Set SW39 → ON, V39 = 1.6V, SW25 → ON and V25 = 1.6V. Then label the non-inverted reference level potential at TP15 as $V_{SRTN}$ and the inverted reference level potential as $V_{SRTNA}$ . Next, label the non-inverted reference level potential at TP15 with V25 = 5.0V as $V_{SRTM}$ and the inverted reference level potential as $V_{SRTMA}$ .	—	-1.8	-1.2	V
138	R SBRT adjustment range (2)	$\Delta V_{SSR2}$	$\Delta V_{SSR1} = (V_{SRTNA} - V_{SRTN}) - (V_{SGTA} - V_{SGT})$ $\Delta V_{SSR2} = (V_{SRTMA} - V_{SRTM}) - (V_{SGTA} - V_{SGT})$	1.2	1.8	—	V
139	B SBRT adjustment range (1)	$\Delta V_{SSB1}$	Set SW39 → ON, V39 = 1.6V, SW24 → ON and V24 = 1.6V. Then label the non-inverted reference level potential at TP17 as $V_{SBTN}$ and the inverted reference level potential as $V_{SBTNA}$ . Next, label the non-inverted reference level potential at TP17 with V24 = 5.0V as $V_{SBTM}$ and the inverted reference level potential as $V_{SBTMA}$ .	—	-1.8	-1.2	V
140	B SBRT adjustment range (2)	$\Delta V_{SSB2}$	$\Delta V_{SSB1} = (V_{SBTNA} - V_{SBTN}) - (V_{SGTA} - V_{SGT})$ $\Delta V_{SSB2} = (V_{SBTMA} - V_{SBTM}) - (V_{SGTA} - V_{SGT})$	1.2	1.8	—	V
141	Reference level difference between R, G and B	$\Delta V_S$	$\Delta V_S = V_{SRT(A)} - V_{SGT(A)}$ , $V_{SGT(A)} - V_{SBT(A)}$ , $V_{SBT(A)} - V_{SRT(A)}$	-200	0	200	mV
142	Gain difference between R, G and B	$\Delta G_{RGB}$	Set V45 = $V_I$ , SW41 → ON, V41 = 1.6V and input SG1 (0dB) to (R IN), (G IN) and (B IN). Then label the non-inverted output amplitudes (black to white) at TP15, TP16 and TP17 as $V_{RVT}$ , $V_{GVT}$ and $V_{BVT}$ , and the inverted output amplitudes as $V_{RVTA}$ , $V_{GVTA}$ and $V_{BVTA}$ , respectively. $\Delta G_{RGB} = 20\log(V_{BVT}/V_{RVT})$ , $20\log(V_{RVT}/V_{GVT})$ , $20\log(V_{GVT}/V_{BVT})$	-0.8	0	0.8	dB
143	Difference between the inverted and non-inverted gain	$\Delta G_{INV}$	$\Delta G_{INV} = 20\log(V_{RVT}/V_{RVTA})$ , $20\log(V_{GVT}/V_{GVTA})$ , $20\log(V_{BVT}/V_{BVTA})$	-0.7	0	0.7	dB
144	Difference between the reference level and 50 IRE	$\Delta V_{50I}$	Set V45 = $V_I$ . Then label the non-inverted output signal reference level amplitudes at TP15, TP16 and TP17 as $V_{SR}$ , $V_{SG}$ and $V_{SB}$ , and the inverted output signal reference level amplitudes as $V_{SRA}$ , $V_{SGA}$ and $V_{SBA}$ , respectively. $V_{50I} = V_{SR(A)} - V_{RVT(A)}/2$ $= V_{SG(A)} - V_{GVT(A)}/2$ $= V_{SB(A)} - V_{BVT(A)}/2$	-150	0	150	mV
145	Gamma intermediate region gain	$G_{GN}$	(See "Black Side Gamma Measurement Method".) Set V45 = $V_I$ . Then measure the minimum gain $G_N$ of the non-inverted and inverted signals at TP15, TP16 and TP17. $G_{GN} = 20 \log(G_N)$	8.0	9.8	12.0	dB
146	Minimum RGB gamma black side gain	$G_{CBN}$	(See "Black Side Gamma Measurement Method".) Set V45 = $V_I$ , V23 = 1.6V and V77 = 1.6V. Then obtain the gamma gain of the non-inverted and inverted signals at TP15, TP16 and TP17.	-1.5	0	1.5	dB

No.	Item	Symbol	Measurement conditions	Min.	Typ.	Max.	Unit
147	Maximum RGB gamma black side gain	$\Delta G_{GBM}$	(See "Black Side Gamma Measurement Method".) Set V45 = Vi, V23 = 1.6V, V68 = 5.0V and V77 = 1.6V. Then obtain the gamma gain of the non-inverted and inverted signals at TP15, TP16 and TP17.	15	18	—	dB
148	Gamma black side gain difference between R, G and B	$\Delta G_{GBT}$	(See "Black Side Gamma Measurement Method".) Set V45 = Vi, V23 = 1.6V, V68 = 3.0V and V77 = 1.6V. Then label the non-inverted side gamma gain at TP15, TP16 and TP17 as GBRT, GBGT and GBBT, and the inverted side gamma gain as GBRTA, GBGTA and GBBTA, respectively. $\Delta G_{GBT} = GBRT(A) - GBGT(A)$ $= GBGT(A) - GBBT(A)$ $= GBBT(A) - GBRT(A)$	-1.0	0	1.0	dB
149	R gamma black side sub gain adjustment range (1)	$\Delta G_{GBR1}$	(See "Black Side Gamma Measurement Method".) Set V45 = Vi, V23 = 1.6V, V68 = 3.0V, V77 = 1.6V, SW69 → ON and V69 = 1.6V. Then measure the gamma gain at TP15, and label the non-inverted side as GBRN and the inverted side as GBRNA	—	-4.5	-2.5	dB
150	R gamma black side sub gain adjustment range (2)	$\Delta G_{GBR2}$	$\Delta G_{GBR1} = GBRN(A) - GBGT(A)$ Next, measure the gamma gain at TP15 with V69 = 5.0V, and label the non-inverted side as GBRM and the inverted side as GBRMA. $\Delta G_{GBR2} = GBRM(A) - GBGT(A)$	2.5	4.5	—	dB
151	B gamma black side sub gain adjustment range (1)	$\Delta G_{GGB1}$	(See "Black Side Gamma Measurement Method".) Set V45 = Vi, V23 = 1.6V, V68 = 3.0V, V77 = 1.6V, SW70 → ON and V70 = 1.6V. Then measure the gamma gain at TP17, and label the non-inverted side as GBBN and the inverted side as GBBNA.	—	-4.5	-2.5	dB
152	B gamma black side sub gain adjustment range (2)	$\Delta G_{GGB2}$	$\Delta G_{GGB1} = GBBN(A) - GBGT(A)$ Next, measure the gamma gain at TP17 with V70 = 5.0V, and label the non-inverted side as GBBM and the inverted side as GBBMA. $\Delta G_{GGB2} = GBBM(A) - GBGT(A)$	2.5	4.5	—	dB
153	Minimum RGB gamma white side gain	GGWN	(See "White Side Gamma Measurement Method".) Set V45 = Vi, V23 = 1.6V, SW41 → ON, V41 = 1.6V, V71 = 1.6V and V74 = 5.0V. Then measure the gamma gain of the non-inverted and inverted sides at TP15, TP16 and TP17.	-1.5	0	1.5	dB
154	Maximum RGB gamma white side gain	GGWN	(See "White Side Gamma Measurement Method".) Set V45 = Vi, V23 = 1.6V, SW41 → ON, V41 = 1.6V, V71 = 5.0V and V74 = 5.0V. Then measure the gamma gain of the non-inverted and inverted sides at TP15, TP16 and TP17.	15	18	—	dB

No.	Item	Symbol	Measurement conditions	Min.	Typ.	Max.	Unit
155	Gamma white side gain difference between R, G and B	$\Delta GGWT$	(See "White Side Gamma Measurement Method".) Set $V_{45} = V_i$ , $V_{23} = 1.6V$ , $V_{71} = 3.0V$ , $V_{74} = 5.0V$ , $SW_{41} \rightarrow ON$ and $V_{41} = 1.6V$ . Then label the non-inverted side gamma gain at TP15, TP16 and TP17 as $G_{WRT}$ , $G_{WGT}$ and $G_{WBT}$ , and the inverted side gamma gain as $G_{WRTA}$ , $G_{WGTA}$ and $G_{WBTA}$ , respectively. $\Delta GGWT = G_{WRT} (A) - G_{WGT} (A)$ $= G_{WGT} (A) - G_{WBT} (A)$ $= G_{WBT} (A) - G_{WRT} (A)$	-1.0	0	1.0	dB
156	R gamma white side sub gain adjustment range (1)	$\Delta GGWR1$	(See "White Side Gamma Measurement Method".) Set $V_{45} = V_i$ , $V_{23} = 1.6V$ , $V_{71} = 3.0V$ , $V_{74} = 5.0V$ , $SW_{41} \rightarrow ON$ , $V_{41} = 1.6V$ , $SW_{72} \rightarrow ON$ and $V_{72} = 1.6V$ . Then measure the gamma gain at TP15, and label the non-inverted side as $G_{WRN}$ and the inverted side as $G_{WRNA}$ . $\Delta GGWR1 = G_{WRN} (A) - G_{WGT} (A)$	—	-4.5	-2.5	dB
157	R gamma white side sub gain adjustment range (2)	$\Delta GGWR2$	Next, measure the gamma gain at TP15 with $V_{72} = 5.0V$ , and label the non-inverted side as $G_{WRM}$ and the inverted side as $G_{WRMA}$ . $\Delta GGWR2 = G_{WRM} (A) - G_{WGT} (A)$	2.5	4.5	—	dB
158	B gamma white side sub gain adjustment range (1)	$\Delta GGWB1$	(See "White Side Gamma Measurement Method".) Set $V_{45} = V_i$ , $V_{23} = 1.6V$ , $V_{71} = 3.0V$ , $V_{74} = 5.0V$ , $SW_{41} \rightarrow ON$ , $V_{41} = 1.6V$ , $SW_{73} \rightarrow ON$ and $V_{73} = 1.6V$ . Then measure the gamma gain at TP17, and label the non-inverted side as $G_{WBN}$ and the inverted side as $G_{WBNA}$ . $\Delta GGWB1 = G_{WBN} (A) - G_{WGT} (A)$	—	-4.5	-2.5	dB
159	B gamma white side sub gain adjustment range (2)	$\Delta GGWB2$	Next, measure the gamma gain at TP17 with $V_{73} = 5.0V$ , and label the non-inverted side as $G_{WBM}$ and the inverted side as $G_{WBMA}$ . $\Delta GGWB2 = G_{WBM} (A) - G_{WGT} (A)$	2.5	4.5	—	dB
160	Minimum RGB gamma black side breakpoint value	$P_{GBN}$	(See "Black Side Gamma Measurement Method".) Set $V_{45} = V_i$ , $V_{23} = 1.6V$ , $V_{68} = 5.0V$ and $V_{77} = 1.6V$ . Then measure the gamma breakpoints of the non-inverted and inverted sides at TP15, TP16 and TP17.	-0.45	-0.15	—	V
161	Maximum RGB gamma black side breakpoint value	$P_{GBM}$	(See "Black Side Gamma Measurement Method".) Set $V_{45} = V_i$ , $V_{23} = 1.6V$ , $V_{68} = 5.0V$ , $V_{77} = 5.0V$ , $SW_1 \rightarrow ON$ and $V_1 = 4.0V$ . Then measure the gamma breakpoints of the non-inverted and inverted sides at TP15, TP16 and TP17.	—	-1.05	-0.75	V

No.	Item	Symbol	Measurement conditions	Min.	Typ.	Max.	Unit
162	Gamma black side breakpoint difference between R, G and B	$\Delta P_{GBT}$	(See "Black Side Gamma Measurement Method".) Set V45 = Vi, V23 = 1.6V, V68 = 5.0V and V77 = 3.3V. Then measure the gamma breakpoints at TP15, TP16 and TP17 and label the non-inverted side as PGBRT, PGBGT and PGBBT, and the inverted side as PGBRTA, PGBGTA and PGBBTA, respectively. $\Delta P_{GBT} = P_{GBRT} (A) - P_{GBGT} (A)$ $= P_{GBGT} (A) - P_{GBBT} (A)$ $= P_{GBBT} (A) - P_{GBRT} (A)$	-0.15	0	0.15	V
163	R gamma black side breakpoint sub adjustment range (1)	$\Delta P_{GBR1}$	(See "Black Side Gamma Measurement Method".) Set V45 = Vi, V23 = 1.6V, V68 = 5.0V, V77 = 3.3V, SW78 → ON and V78 = 1.6V. Then measure the gamma breakpoint at TP15, and label the non-inverted side as PGBRN and the inverted side as PGBRNA.	0.15	0.3	—	V
164	R gamma black side breakpoint sub adjustment range (2)	$\Delta P_{GBR2}$	$\Delta P_{GBR1} = P_{GBRN} (A) - P_{GBGT} (A)$ Next, measure the gamma breakpoint at TP15 with V78 = 5.0V, SW1 → ON and V1 = 4.0V, and label the non-inverted side as PGBRM and the inverted side as PGBMA. $\Delta P_{GBR2} = P_{GBRM} (A) - P_{GBGT} (A)$	—	-0.3	-0.15	V
165	B gamma black side breakpoint sub adjustment range (1)	$\Delta P_{GBB1}$	(See "Black Side Gamma Measurement Method".) Set V45 = Vi, V23 = 1.6V, V68 = 5.0V, V77 = 3.3V, SW79 → ON and V79 = 1.6V. Then measure the gamma breakpoint at TP17, and label the non-inverted side as PGBBN and the inverted side as PGBBNA.	0.15	0.3	—	V
166	B gamma black side breakpoint sub adjustment range (2)	$\Delta P_{GBB2}$	$\Delta P_{GBB1} = P_{GBBN} (A) - P_{GBGT} (A)$ Next, measure the gamma breakpoint at TP17 with V79 = 5.0V, SW1 → ON and V1 = 4.0V, and label the non-inverted side as PGBBM and the inverted side as PGBBMA. $\Delta P_{GBB2} = P_{GBBM} (A) - P_{GBGT} (A)$	—	-0.3	-0.15	V
167	Minimum RGB gamma white side breakpoint value	$P_{GWN}$	(See "White Side Gamma Measurement Method".) Set V45 = Vi, V23 = 1.6V, V71 = 5.0V, V74 = 5.0V, SW41 → ON and V41 = 1.6V. Then measure the gamma breakpoints of the non-inverted and inverted sides at TP15, TP16 and TP17.	—	-0.35	-0.05	V
168	Maximum RGB gamma white side breakpoint value	$P_{GWM}$	(See "White Side Gamma Measurement Method".) Set V45 = Vi, V23 = 1.6V, V71 = 5.0V, V74 = 1.6V, SW1 → ON, V1 = 2.3V, SW41 → ON and V41 = 1.6V. Then measure the gamma breakpoints of the non-inverted and inverted sides at TP15, TP16 and TP17.	0.75	1.20	—	V
169	Gamma white side breakpoint difference between R, G and B	$\Delta P_{GWT}$	(See "White Side Gamma Measurement Method".) Set V45 = Vi, V23 = 1.6V, V71 = 5.0V, V74 = 3.3V, SW41 → ON and V41 = 1.6V. Then measure the gamma breakpoints at TP15, TP16 and TP17 and label the non-inverted sides as PGWRT, PGWGT and PGWBT, and the inverted sides as PGWRTA, PGWGTA and PGWBTA, respectively. $\Delta P_{GWT} = P_{GWRT} (A) - P_{GWGT} (A)$ $= P_{GWGT} (A) - P_{GWBT} (A)$ $= P_{GWBT} (A) - P_{GWRT} (A)$	-0.15	0	0.15	V

No.	Item	Symbol	Measurement conditions	Min.	Typ.	Max.	Unit
170	R gamma white side breakpoint sub adjustment range (1)	$\Delta P_{GWR1}$	(See "White Side Gamma Measurement Method".) Set $V_{45} = V_1$ , $V_{23} = 1.6V$ , $V_{71} = 5.0V$ , $V_{74} = 3.3V$ , $SW_{41} \rightarrow ON$ and $V_{41} = 1.6V$ . Then measure the gamma breakpoint at TP16, and label the non-inverted side as $P_{GWGT}$ and the inverted side as $P_{GWGTA}$ . Next, measure the gamma breakpoint at TP15 with $SW_{75} \rightarrow ON$ and $V_{75} = 5.0$ , and label the non-inverted side as $P_{GWRN}$ and the inverted side as $P_{GWRNA}$ . $\Delta P_{GWR1} = P_{GWRN} (A) - P_{GWGT} (A)$	—	-0.3	-0.15	V
171	R gamma white side breakpoint sub adjustment range (2)	$\Delta P_{GWR2}$	Next, measure the gamma breakpoint at TP15 with $V_{75} = 1.6V$ , $SW_1 \rightarrow ON$ and $V_1 = 2.3V$ , and label the non-inverted side as $P_{GWRM}$ and the inverted side as $P_{GWRMA}$ . $\Delta P_{GWR2} = P_{GWRM} (A) - P_{GWGT} (A)$	0.15	0.3	—	V
172	B gamma white side breakpoint sub adjustment range (1)	$\Delta P_{GWB1}$	(See "White Side Gamma Measurement Method".) Set $V_{45} = V_1$ , $V_{23} = 1.6V$ , $V_{71} = 5.0V$ , $V_{74} = 3.3V$ , $SW_{41} \rightarrow ON$ , $V_{41} = 1.6V$ , $SW_{76} \rightarrow ON$ and $V_{76} = 5.0V$ . Then measure the gamma breakpoint at TP17, and label the non-inverted side as $P_{GWBN}$ and the inverted side as $P_{GWBNA}$ . $\Delta P_{GWB1} = P_{GWBN} (A) - P_{GWGT} (A)$	—	-0.3	-0.15	V
173	B gamma white side breakpoint sub adjustment range (2)	$\Delta P_{GWB2}$	Next, measure the gamma breakpoint at TP17 with $V_{75} = 1.6V$ , $SW_1 \rightarrow ON$ and $V_1 = 2.3V$ , and set the non-inverted side as $P_{GWB M}$ and the inverted side as $P_{GWBMA}$ . $\Delta P_{GWB2} = P_{GWB M} (A) - P_{GWGT} (A)$	0.15	0.3	—	V
174	WHT LIM standard voltage value	$V_{WT}$	Set $V_{45} = 5.0V$ , $V_{42} = 0V$ , $V_{54} = 0V$ and input $SG_1$ (0dB) to (TEST IN). Label the non-inverted output amplitudes (black to white) at TP15, TP16 and TP17 as $V_{WRLT}$ , $V_{WGLT}$ and $V_{WBLT}$ , and the inverted output amplitudes as $V_{WRLTA}$ , $V_{WGLTA}$ and $V_{WBLTA}$ , respectively. Next, label the non-inverted output amplitudes (black to white) at TP15, TP16 and TP17 with $SW_{41} \rightarrow ON$ and $V_{41} = 5.0V$ as $V_{WRLN}$ , $V_{WGLN}$ and $V_{WBLN}$ , and the inverted output amplitudes as $V_{WRLNA}$ , $V_{WGLNA}$ and $V_{WBLNA}$ , respectively.	1.7	2.0	2.3	V
175	WHT LIM adjustment range (1)	$\Delta V_{W1}$	Next, label the non-inverted output amplitudes (black to white) at TP15, TP16 and TP17 with $V_{41} = 1.6V$ as $V_{WRLM}$ , $V_{WGLM}$ and $V_{WBLM}$ , and the inverted output amplitudes as $V_{WRLMA}$ , $V_{WGLMA}$ and $V_{WBLMA}$ , respectively. $V_{WT} = V_{WRLT} (A), V_{WGLT} (A), V_{WBLT} (A)$	—	-1.7	-1.3	V
176	WHT LIM adjustment range (2)	$\Delta V_{W2}$	$\Delta V_{W1} = V_{WRLN} (A) - V_{WRLT} (A)$ $= V_{WGLN} (A) - V_{WGLT} (A)$ $= V_{WBLN} (A) - V_{WBLT} (A)$ $\Delta V_{W2} = V_{WRLM} (A) - V_{WRLT} (A)$ $= V_{WGLM} (A) - V_{WGLT} (A)$ $= V_{WBLM} (A) - V_{WBLT} (A)$	2.4	2.8	—	V

No.	Item	Symbol	Measurement conditions	Min.	Typ.	Max.	Unit
177	BLK LIM standard voltage value (non-inverted side)	$V_{BLT}$	Set $V23 = 1.6V$ and $V37 = 2.8V$ . Then label the DC voltages at TP15, TP16 and TP17 as $V_{CR1}$ , $V_{CG1}$ and $V_{CB1}$ , respectively. Next, set $V23 = 5.0V$ , $SW26 \rightarrow (b)$ , $SW27 \rightarrow (b)$ , $SW28 \rightarrow (b)$ , $V26 = 7.0V$ , $V27 = 7.0V$ and $V28 = 7.0V$ , and then label the non-inverted limiter levels at TP15, TP16 and TP17 as $V_{BRLT}$ , $V_{BGLT}$ and $V_{BBLT}$ , and the inverted limiter levels as $V_{BRLTA}$ , $V_{BGLTA}$ and $V_{BBLTA}$ , respectively.	4.2	4.8	5.4	V
178	BLK LIM standard voltage value (inverted side)	$V_{BLTA}$	Next, label the non-inverted limiter levels at TP15, TP16 and TP17 with $SW39 \rightarrow ON$ and $V39 = 1.6V$ as $V_{BRLM}$ , $V_{BGLM}$ and $V_{BBLM}$ , and the inverted limiter levels as $V_{BRLMA}$ , $V_{BGLMA}$ and $V_{BBLMA}$ , respectively. Next, label the non-inverted limiter levels at TP15, TP16 and TP17 with $V39 = 5.0V$ as $V_{BRLN}$ , $V_{BGLN}$	4.2	4.8	5.4	V
179	BLK LIM adjustment range (1) (non-inverted side)	$\Delta V_{BL1}$	and $V_{BBLN}$ , and the inverted limiter levels as $V_{BRLNA}$ , $V_{BGLNA}$ and $V_{BBLNA}$ , respectively. $V_{BLT} = V_{CR1} - V_{BRLT}$ $= V_{CG1} - V_{BGLT}$ $= V_{CB1} - V_{BBLT}$ $V_{BLTA} = V_{BRLTA} - V_{CR1}$ $= V_{BGLTA} - V_{CG1}$ $= V_{BBLTA} - V_{CB1}$	0.7	1.2	—	V
180	BLK LIM adjustment range (2) (non-inverted side)	$\Delta V_{BL2}$	$\Delta V_{BL1} = (V_{CR1} - V_{BRLM})$ $- (V_{CR1} - V_{BRLT})$ $= (V_{CG1} - V_{BGLM})$ $- (V_{CG1} - V_{BGLT})$ $= (V_{CB1} - V_{BBLM})$ $- (V_{CB1} - V_{BBLT})$ $\Delta V_{BL2} = (V_{CR1} - V_{BRLN})$ $- (V_{CR1} - V_{BRLT})$ $= (V_{CG1} - V_{BGLN})$ $- (V_{CG1} - V_{BGLT})$ $= (V_{CB1} - V_{BBLN})$ $- (V_{CB1} - V_{BBLT})$	—	-2.7	-2.2	V
181	BLK LIM adjustment range (3) (inverted side)	$\Delta V_{BL3}$	$\Delta V_{BL3} = (V_{BRLMA} - V_{CR1})$ $- (V_{BRLTA} - V_{CR1})$ $= (V_{BGLMA} - V_{CG1})$ $- (V_{BGLTA} - V_{CG1})$ $= (V_{BBLMA} - V_{CB1})$ $- (V_{BBLTA} - V_{CB1})$	-0.5	0	0.5	V
182	BLK LIM adjustment range (4) (inverted side)	$\Delta V_{BL4}$	$\Delta V_{BL4} = (V_{BRLNA} - V_{CR1})$ $- (V_{BRLTA} - V_{CR1})$ $= (V_{BGLNA} - V_{CG1})$ $- (V_{BGLTA} - V_{CG1})$ $= (V_{BBLNA} - V_{CB1})$ $- (V_{BBLTA} - V_{CB1})$	—	-2.7	-2.2	V
183	RGB output DC voltage	$V_{CRGB}$	Set $V42 = 0V$ and $V23 = 2.1V$ . Then label the DC voltages at TP15, TP16 and TP17 as $V_{CRT}$ , $V_{CGT}$ and $V_{CBT}$ , respectively. $V_{CRGB} = V_{CRT}$ , $V_{CGT}$ , $V_{CBT}$	6.35	6.50	6.65	V
184	SID output DC voltage	$V_{CSID}$	Set $V31 = 1.6V$ , $SW30 \rightarrow ON$ and $V30 = 1.6V$ . Then measure the DC voltage at TP13.	6.35	6.50	6.65	V

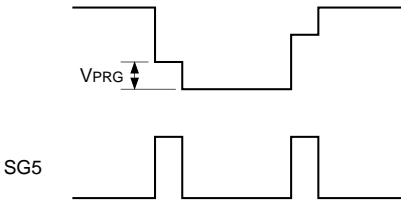
No.	Item	Symbol	Measurement conditions	Min.	Typ.	Max.	Unit
185	DC voltage difference between RGB and SID outputs	$\Delta V_{CSRGB}$	Set $V_{42} = 0V$ , $V_{31} = 1.6V$ , $SW_{30} \rightarrow ON$ , $V_{30} = 1.6V$ and $V_{37} = 2.8V$ . Then measure the DC voltages at TP13, TP15, TP16 and TP17, and level these voltages as $V_{CS2}$ , $V_{CR2}$ , $V_{CG2}$ and $V_{CB2}$ , respectively. $\Delta V_{CSRGB} = V_{CS2} - V_{CR2}$ , $V_{CS2} - V_{CG2}$ , $V_{CS2} - V_{CB2}$ $= V_{CR2} - V_{CG2}$ , $V_{CR2} - V_{CB2}$ , $V_{CG2} - V_{CB2}$	-150	0	150	mV
186	Minimum SIG CENT adjustment voltage	$V_{C1}$	Set $V_{42} = 0V$ , $V_{37} = 5.0V$ , $SW_{37} \rightarrow ON$ . Then measure the DC voltages at TP13, TP15, TP16 and TP17.	—	4.7	5.3	V
187	Maximum SIG CENT adjustment voltage	$V_{C2}$	Set $V_{42} = 0V$ , $V_{37} = 1.6V$ , $SW_{37} \rightarrow ON$ . Then measure the DC voltages at TP15, TP16 and TP17.	7.7	8.3	—	V
188	DC voltage difference between VCOM OUT and RGB output	$\Delta V_{COM}$	$\Delta V_{COM} = V_{CRT} - V_{COM}$ $= V_{CGT} - V_{COM}$ $= V_{CBT} - V_{COM}$	100	300	500	mV
189	VCOM control range (1)	$\Delta V_{COM1}$	Set $SW_{36} \rightarrow ON$ and $V_{36} = 5.0V$ . Then label the voltage at TP38 as $V_{COM1}$ . $\Delta V_{COM1} = V_{CRT} - V_{COM1}$ $= V_{CGT} - V_{COM1}$ $= V_{CBT} - V_{COM1}$	—	-1.9	-1.6	V
190	VCOM control range (2)	$\Delta V_{COM2}$	Set $SW_{36} \rightarrow ON$ and $V_{36} = 1.6V$ . Then label the voltage at TP38 as $V_{COM2}$ . $\Delta V_{COM2} = V_{CRT} - V_{COM2}$ $= V_{CGT} - V_{COM2}$ $= V_{CBT} - V_{COM2}$	2.1	2.4	—	V
191	SID OUT amplitude	$V_{SID}$	Set $V_{31} = 1.6V$ . Then measure the output amplitude at TP13.	8.3	9.3	10.3	Vp-p
192	Maximum SID CTR control voltage	$V_{SMAX}$	Set $V_{31} = 1.6V$ , $SW_{30} \rightarrow ON$ , $V_{30} = 5.0V$ and $V_{CC2} = 13V$ . Then measure the output amplitude at TP13.	10	11	—	Vp-p
193	Minimum SID CTR control voltage	$V_{SMIN}$	Set $V_{31} = 1.6V$ , $SW_{30} \rightarrow ON$ , $V_{30} = 1.6V$ and $V_{CC2} = 13V$ . Then measure the output amplitude at TP13.	—	5.0	6.5	Vp-p
194	Maximum PRG CTR control voltage	$V_{PRGM}$	Set $V_{31} = 5.0V$ . Then measure the amplitude of the PRG section using the output waveform at TP13. 	2.0	3.2	—	Vp-p

No.	Item	Symbol	Measurement conditions	Min.	Typ.	Max.	Unit
195	Minimum PRG CTR control voltage	VPRGN	Set V31 = 1.6V. Then measure the amplitude of the PRG section using the output waveform at TP13.	—	0	0.4	Vp-p
196	Frequency response (1) (RGB input – RGB output)	f <sub>RGB</sub>	Frequency response from (R IN), (G IN) and (B IN) to TP15, TP16 and TP17 (frequency which goes to –3dB with respect to 100kHz)	—	18	—	MHz
197	Frequency response (3) (RGB input – $\gamma$ )	f <sub><math>\gamma</math></sub>	Frequency response from (R IN), (G IN) and (B IN) to the sample-and-hold circuit input (frequency which goes to –3dB with respect to 100kHz)	20	25	—	MHz
198	Slew rate (RGB input – RGB output)	RSRGB	Input SG6 to (R IN), (G IN) and (B IN). Then adjust V45 so that the output amplitude (black to white) at TP16 is 3V. Measure the slew rate from the 10 to 90% rise and fall time of TP15, TP16 and TP17.	60	100	—	V/ $\mu$ s
199	Input dynamic range	VDIN	Set SW41 → ON, V41 = 1.6V and input SG1 (variable amplitude) to (R IN), (G IN) and (B IN). Then label the amplitude of the 1st, 5th and 10th steps as b1, b5 and b10, respectively, using the non-inverted output waveform at TP15, TP16 and TP17. The input dynamic range is defined as the minimum value for the input amplitude (black to white) at which b1/b5 < 0.8 or b10/b5 < 0.8.	0.8	1.1	—	Vp-p
200	Sample-and-hold circuit droop rate	RDLP	Set V45 = V <sub>I</sub> and input SG7 to (SH1), (SH2) and (SH3). Then measure the droop rate at TP15, TP16 and TP17. Next, input SG7 to (SH4). Then measure the droop rate of TP15, TP16 and TP17.	—	—	40	mV/ $\mu$ s
201	GAM OUT reference voltage amplitude	V <sub>GS</sub>	Measure the reference signal voltage amplitude of TP7.	0.15	0.22	0.29	Vp-p
202	GAM OUT GAIN (Maximum GAM gain)	G <sub>G</sub>	Input SG1 to (G IN). Then measure the output amplitude (black to white) of TP7, and label it as V <sub>G</sub> .	–5.2	–4.2	–3.2	dB

**Note)** The symbol (A) in the Measurement conditions inscription indicates that the measurement values for both the inverted and non-inverted sides are used.

**(Example)**

20 log (V<sub>RSM(A)</sub>/V<sub>RST(A)</sub>) means both

20 log (V<sub>RSM</sub>/V<sub>RST</sub>) and

20 log (V<sub>RSMA</sub>/V<sub>RSTA</sub>).

In this example, V<sub>RSM</sub> and V<sub>RST</sub> are non-inverted side measurement values and V<sub>RSMA</sub> and V<sub>RSTA</sub> are inverted side measurement values.

**Black Side Gamma Measurement Method**

Measure the output voltages  $y_1$  to  $y_{10}$  which correspond to the input voltages  $a_1$  to  $a_{10}$  using SG8 as the input signal. (Measure the voltage from the reference level. Label the white side from the reference level as positive, and the black side as negative.)

Select the two points where  $|y_n - y_{n-1}|$  ( $n = 2$  to  $10$ ) is a maximum, and label these points  $y_k$  and  $y_{k-1}$ . Also, label the input voltages which correspond to  $y_k$  and  $y_{k-1}$  as  $a_k$  and  $a_{k-1}$ , respectively.

Next, measure the output voltages  $y_1$  to  $y_{10}$  which correspond to the input voltages  $a_1$  to  $a_{10}$  using SG9 as the input signal.

Select the two points where  $|y_n - y_{n-1}|$  ( $n = 2$  to  $10$ ) is a maximum, and label these points  $y_h$  and  $y_{h-1}$ . Also, label the input voltages which correspond to  $y_h$  and  $y_{h-1}$  as  $a_h$  and  $a_{h-1}$ , respectively.

From the above:

$$\text{Maximum gain } GM = (y_k - y_{k-1}) / (a_k - a_{k-1})$$

$$\text{Minimum gain } GN = (y_h - y_{h-1}) / (a_h - a_{h-1})$$

The black side gamma gain is defined as the ratio of the maximum gain to the minimum gain. In other words:

$$\text{Gamma gain} = 20 \log (GM/GN)$$

The gamma breakpoint is defined as the intersection between the straight line passing through points  $(a_k, y_k)$  and  $(a_{k-1}, y_{k-1})$  and the straight line passing through points  $(a_h, y_h)$  and  $(a_{h-1}, y_{h-1})$ . In other words:

$$\text{Gamma breakpoint} = (GM * GN * (a_k - a_h) - GN * y_k + GM * y_h) / (GM - GN)$$

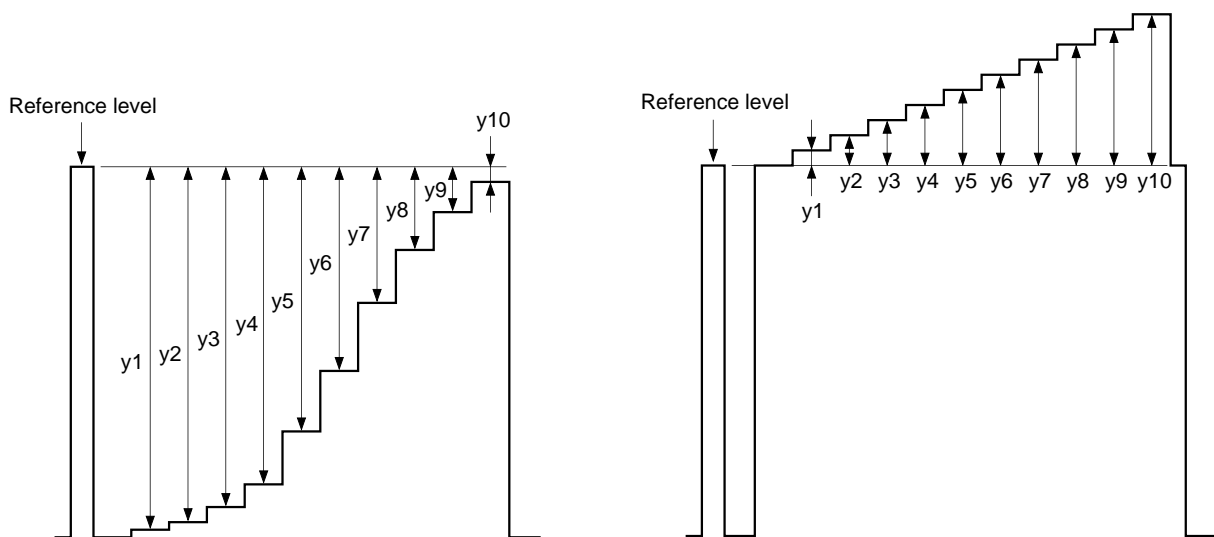

**RGB output waveform (SG8)**

**RGB output waveform (SG9)**

**White Side Gamma Measurement Method**

Measure the output voltages  $y_1$  to  $y_{10}$  which correspond to the input voltages  $a_1$  to  $a_{10}$  using SG9 as the input signal. (Measure the voltage from the reference level. Label the white side from the reference level as positive, and the black side as negative.)

Select the two points where  $|y_n - y_{n-1}|$  ( $n = 2$  to  $10$ ) is a maximum, and label these points  $y_k$  and  $y_{k-1}$ . Also, label the input voltages which correspond to  $y_k$  and  $y_{k-1}$  as  $a_k$  and  $a_{k-1}$ , respectively.

Next, measure the output voltages  $y_1$  to  $y_{10}$  which correspond to the input voltages  $a_1$  to  $a_{10}$  using SG8 as the input signal.

Select the two points where  $|y_n - y_{n-1}|$  ( $n = 2$  to  $10$ ) is a maximum, and label these points  $y_h$  and  $y_{h-1}$ . Also, label the input voltages which correspond to  $y_h$  and  $y_{h-1}$  as  $a_h$  and  $a_{h-1}$ , respectively.

From the above:

$$\text{Maximum gain } GM = (y_k - y_{k-1}) / (a_k - a_{k-1})$$

$$\text{Minimum gain } GN = (y_h - y_{h-1}) / (a_h - a_{h-1})$$

The white side gamma gain is defined as the ratio of the maximum gain to the minimum gain. In other words:

$$\text{Gamma gain} = 20 \log (GM/GN)$$

The gamma breakpoint is defined as the intersection between the straight line passing through points  $(a_k, y_k)$  and  $(a_{k-1}, y_{k-1})$  and the straight line passing through points  $(a_h, y_h)$  and  $(a_{h-1}, y_{h-1})$ . In other words:

$$\text{Gamma breakpoint} = (GM * GN * (a_k - a_h) - GN * y_k + GM * y_h) / (GM - GN)$$

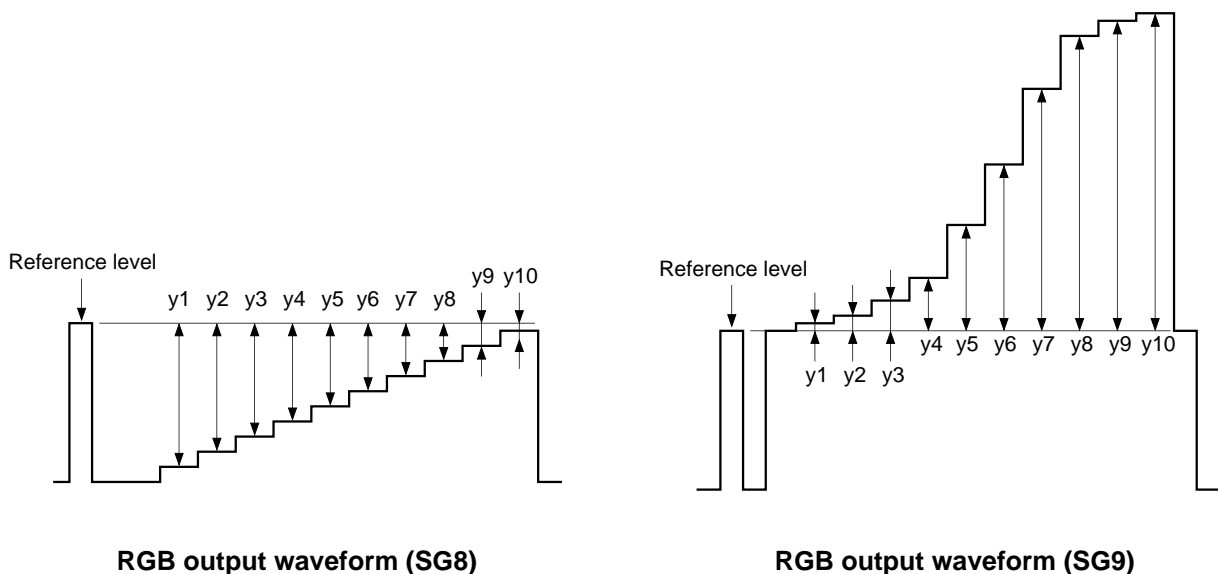

Input Waveforms

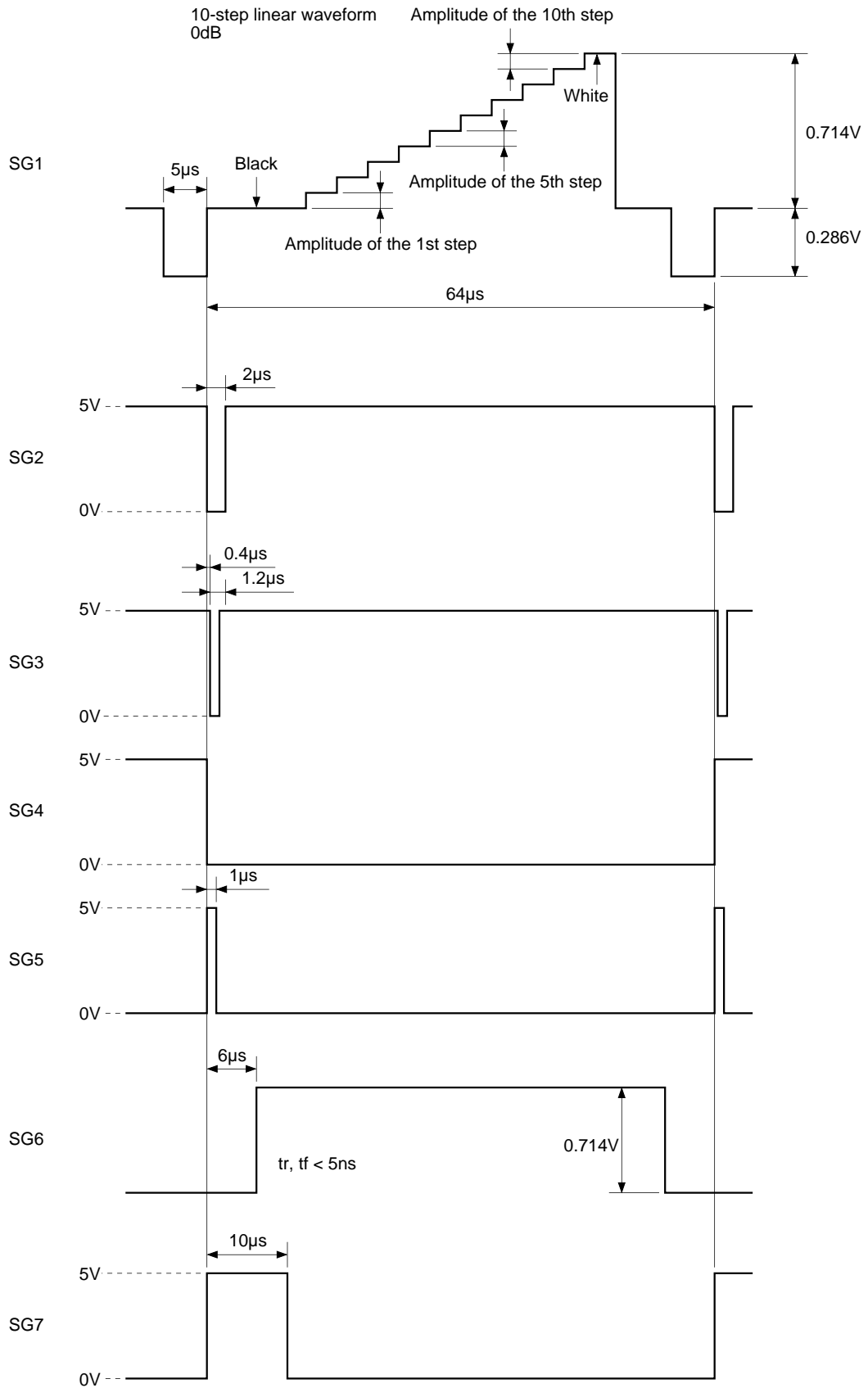

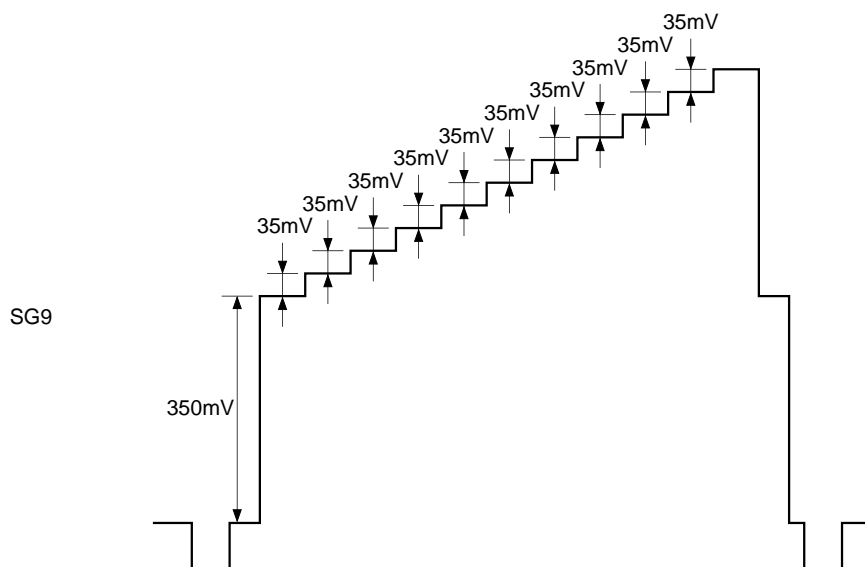
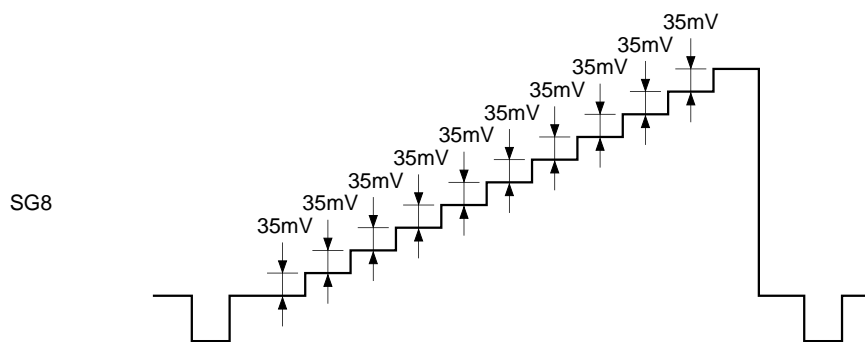

Electrical Characteristics Measurement Circuit

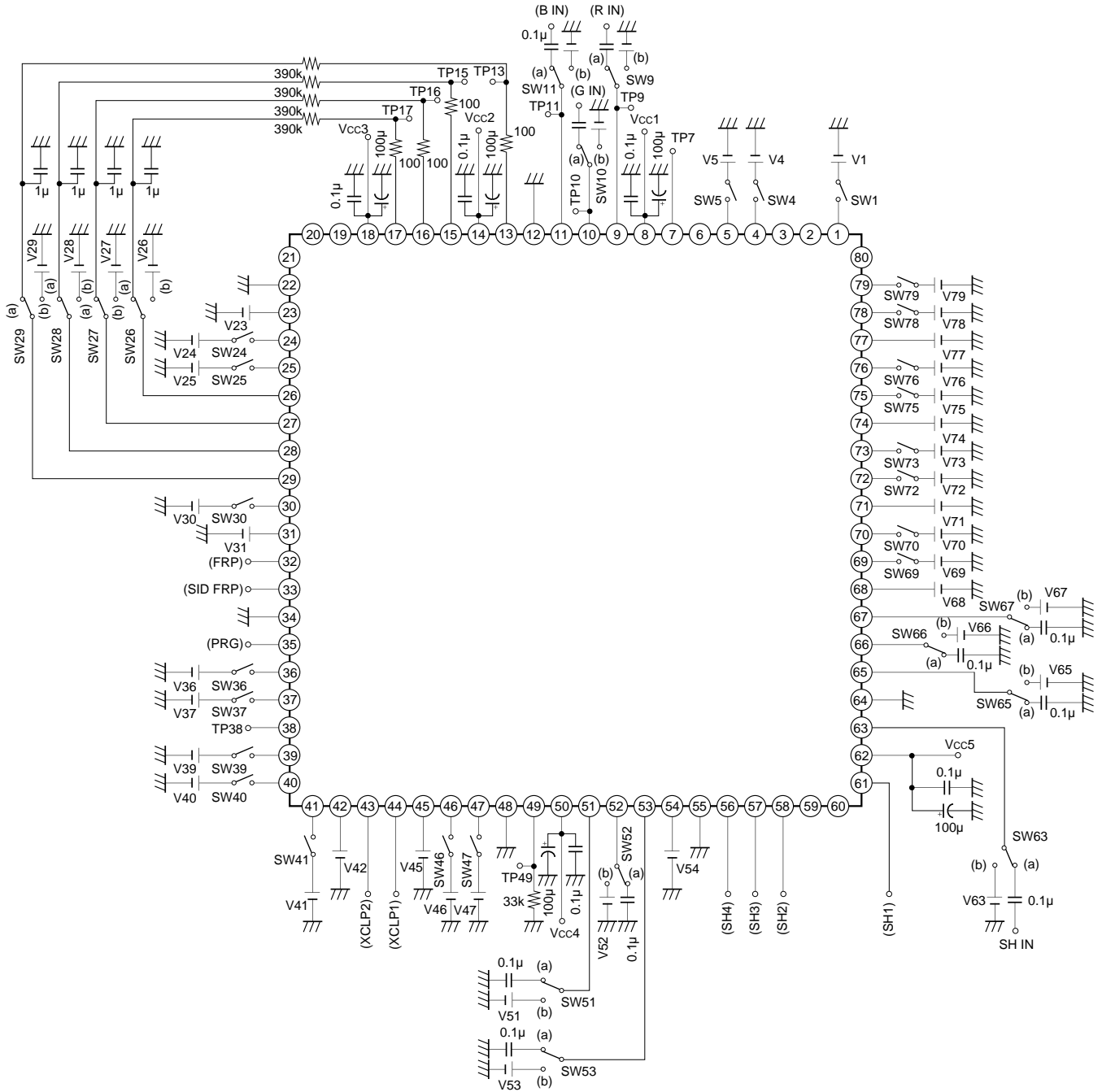

**Description of Operation**

**Reference signal**

The reference level is inserted into the RGB signal by inputting the XCLP2 signal shown below during the RGB input signal pedestal level interval. Gamma compensation and clamping operation are performed based on this level.

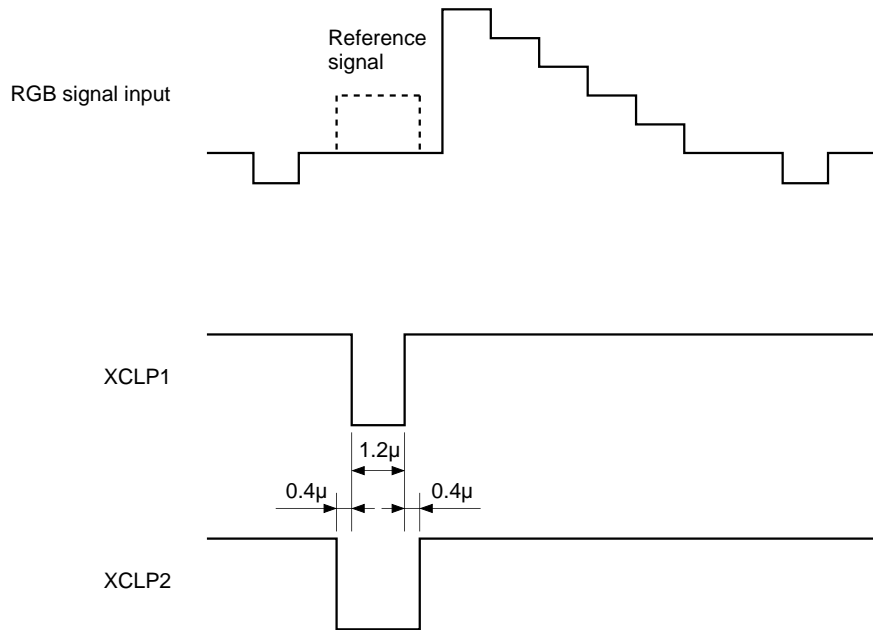

**Bright adjustment**

The position of the RGB signal relative to the reference level changes according to the voltage applied to RGB MBRT (Pin 1). Bright can be controlled without changing the  $\gamma$  characteristics to the panel because the input bias is changed with the breakpoint for output kept constant.

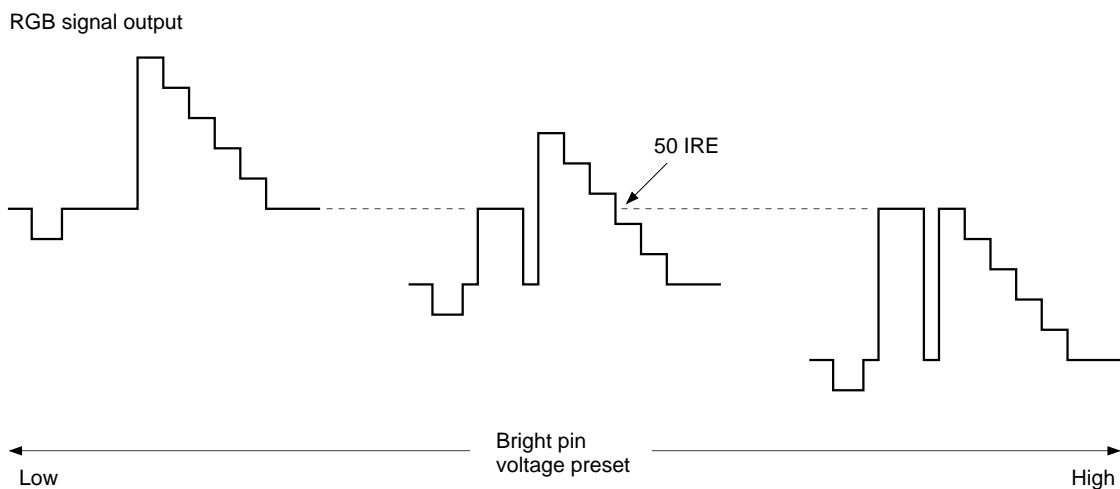

**Gamma compensation**

The gamma compensation curve establishes the gain change points (breakpoints) on both the black and white sides from the reference level. The black and white side gains and the black and white side gain change points can each be adjusted independently.

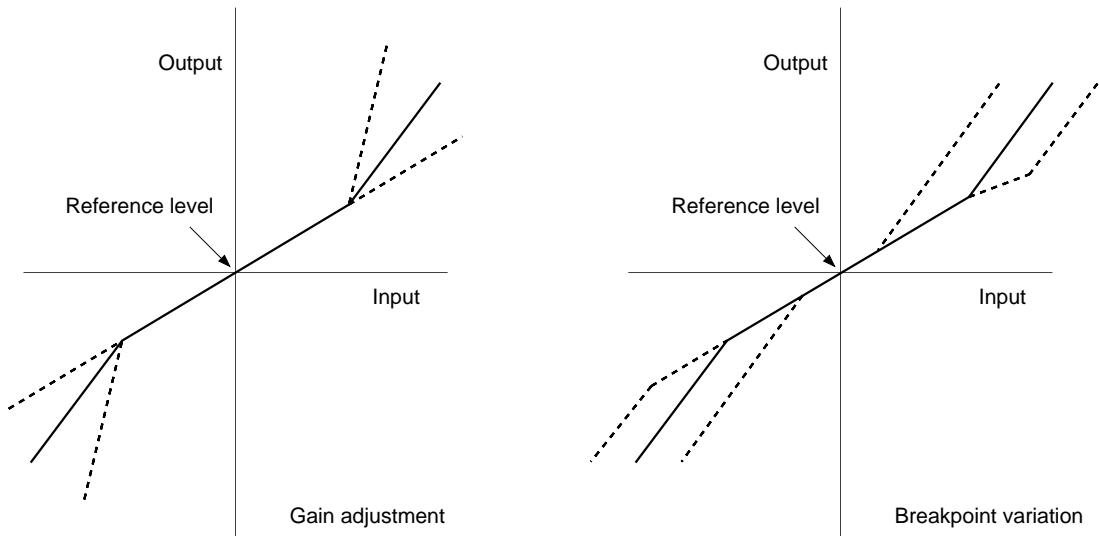

**Sample-and-hold, gain control and pedestal clamp**

Since sample-and-hold circuits are established in the R, G and B lines and each of these circuits is operated by an independent pulse, the delay can be set freely. In addition, the pulse leak is canceled by establishing a sample-and-hold circuit in the clamp loop and inputting the differential input of the gain control circuit.

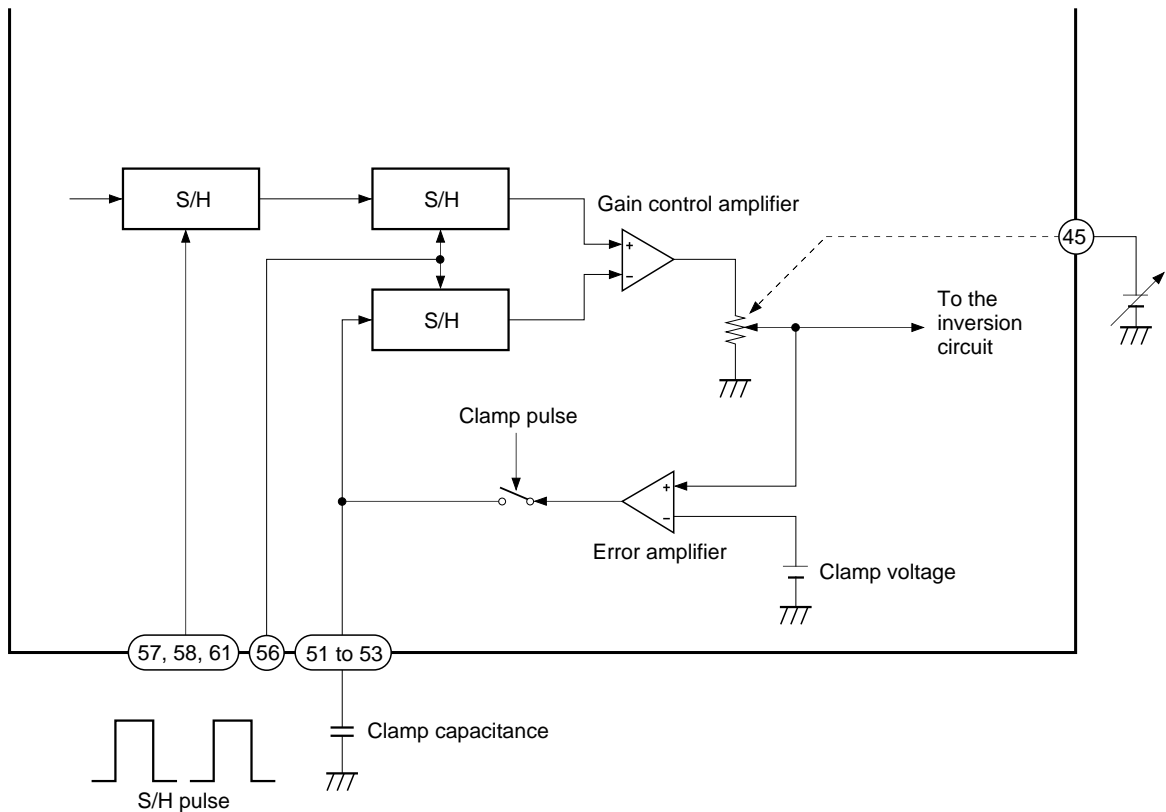

**RGB inversion amplifier**

The polarity of the RGB output is inverted according to the FRP pulse. The relationship between input and output is as shown in the figure below.

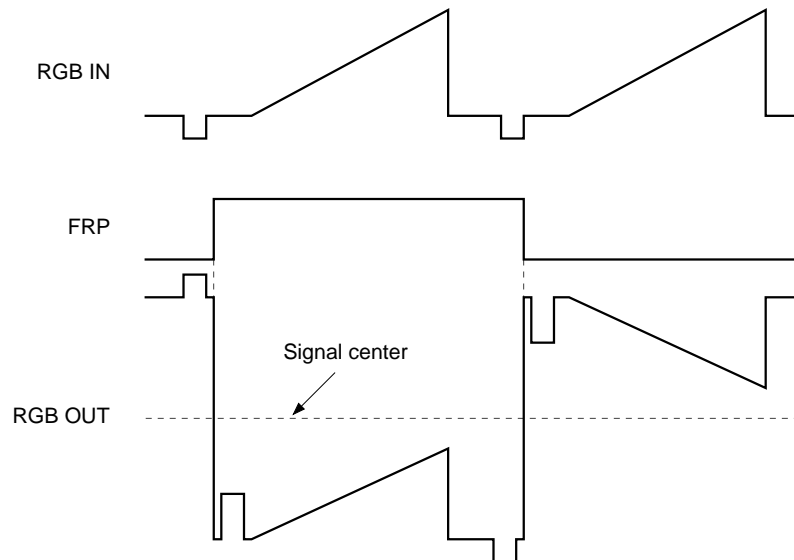

**SID output**

The CXA1853Q outputs a side black signal for 4:3/16:9 aspect conversion. The black level is adjusted by the SID CTR pin. In addition, the PRG level can be set in part of the side black signal by inputting the PRG pulse. The PRG level is adjusted by the PRG CTR pin. The relationship between each input and output is as shown in the figure below.

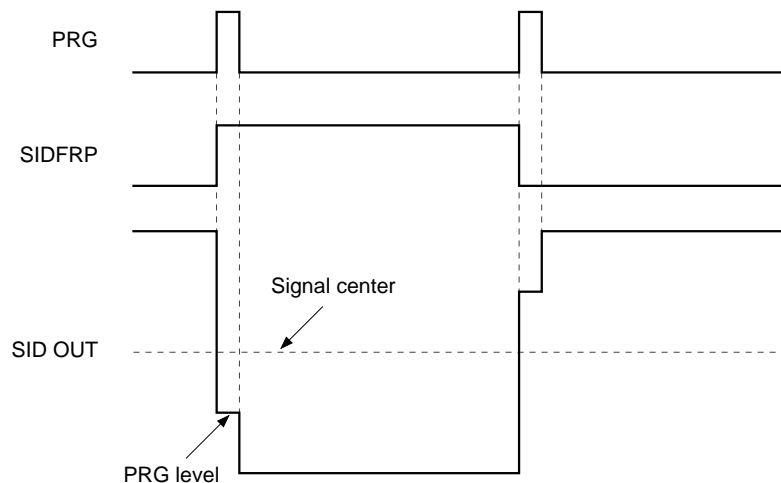

**Signal center control**

The RGB and SID output center voltages are adjusted by the SIG CENT CTR (Pin 37). When SIG CENT CTR is preset, the output pin center voltage goes to  $V_{cc2}/2$ .

**Output clamp**

The average value of each RGB and SID output signal is detected with external RC circuits and input to the RGB CLP and SID CLP pins. Then the center voltage offsets among R, G, B and SID outputs are reduced by feedback which equalizes these detected values and the signal center voltage set by the SIG CENT CTR pin.

## Notes on Operation

### 1) R IN (Pin 9), G IN (Pin 10), B IN (Pin 11) input signal impedance

An external capacitor is used as the hold capacitor for the clamp at the input of this IC. Therefore, the input signal impedance must be sufficiently low ( $75\Omega$  or less) and the external capacitor must have a small leak current.

### 2) Clamp hold capacitors (Pins 51 to 53 and 65 to 67)

The external capacitors connected to these pins must have a small leak current.

### 3) R, G, B, SID OUT load capacitance

The output signal will tend to oscillate if the R, G, B and SID OUT load capacitance increases. Be sure to insert a 100 to  $220\Omega$  resistor in series to these output pins, and design to keep the load capacitance from exceeding  $30\text{pF}$ .

### 4) External capacitor at the output

The leak current absolute value and tolerance for the R, G, B and SID OUT average value detecting capacitors should be small.

Note that if there is an offset in the leak current between R, G and B, offset voltage is also generated between R, G and B in the external resistor, which causes a DC offset of the output signal.

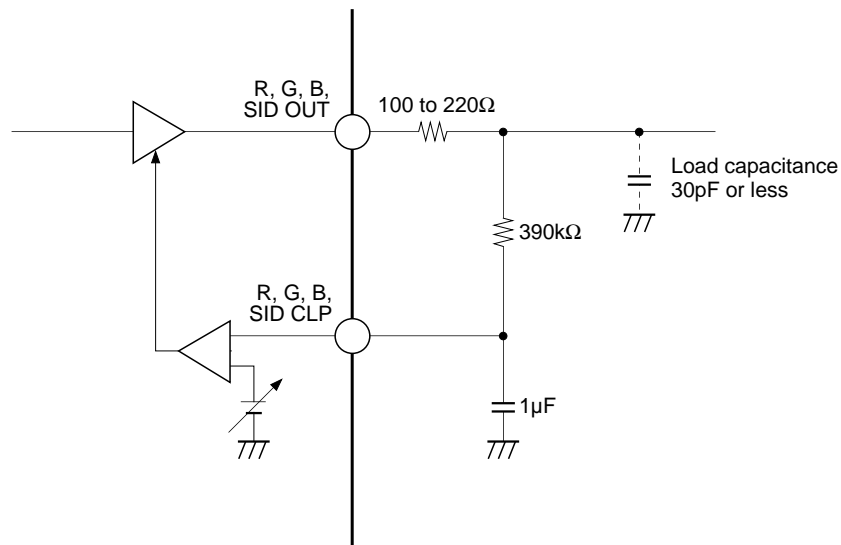

### 5) GND and power supply pins

Pins 12, 22, 34, 48, 55 and 64 (GND) should be set to the minimum identical potential applied to the IC, and should not be left open. In addition, the potential at Pins 8, 18, 50 and 62 should be the same.

Application Circuit

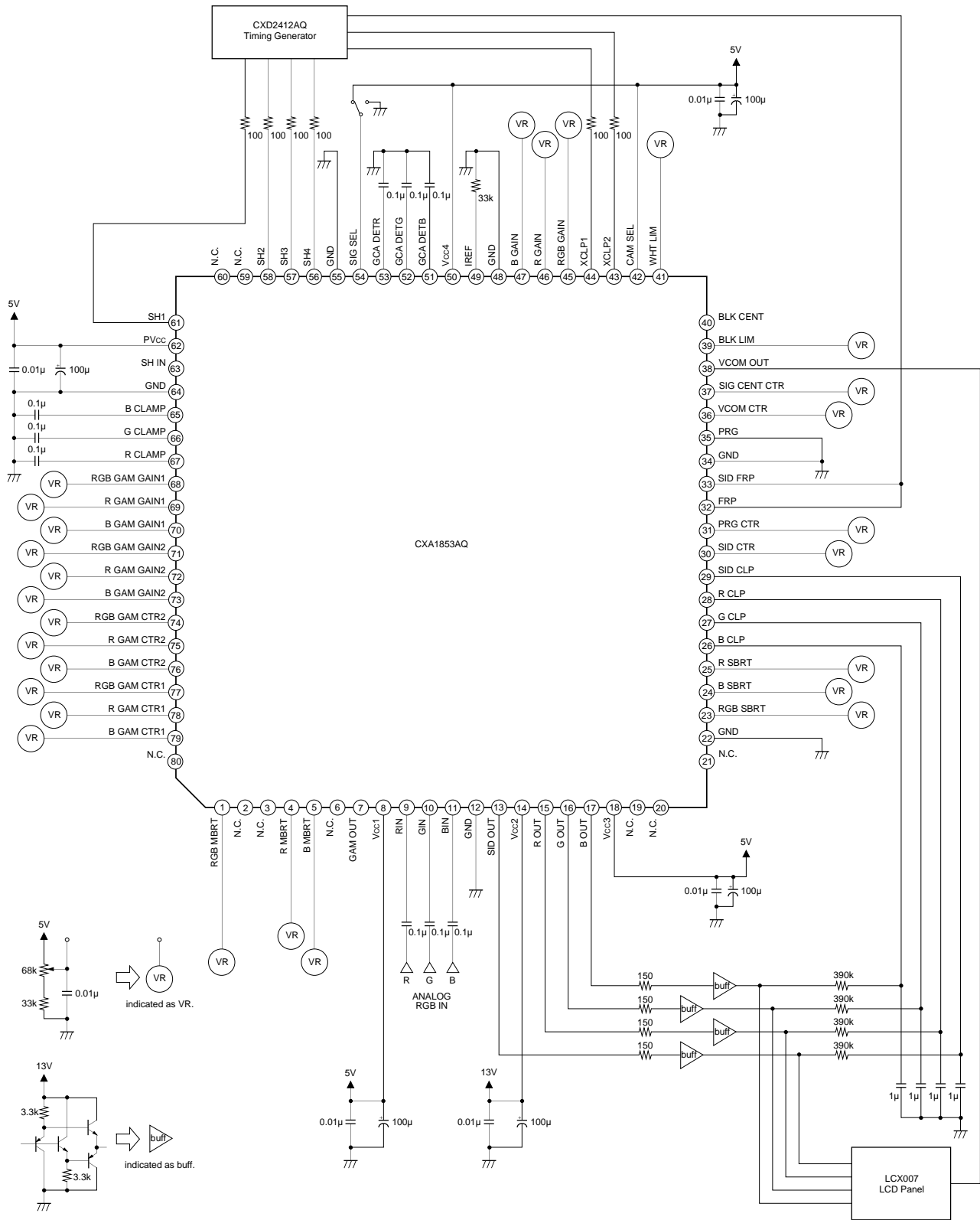

Application circuits shown are typical examples illustrating the operation of the devices. Sony cannot assume responsibility for any problems arising out of the use of these circuits or for any infringement of third party patent and other right due to same.

Example of Representative Characteristics

RGB GAIN adjustment range

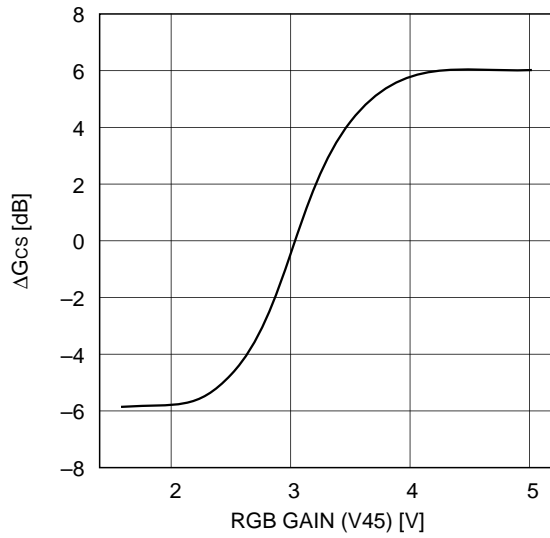

R GAIN, B GAIN adjustment range

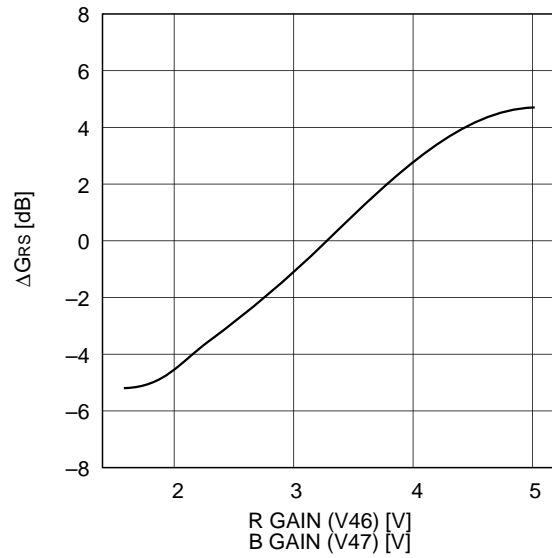

RGB MBRT adjustment range

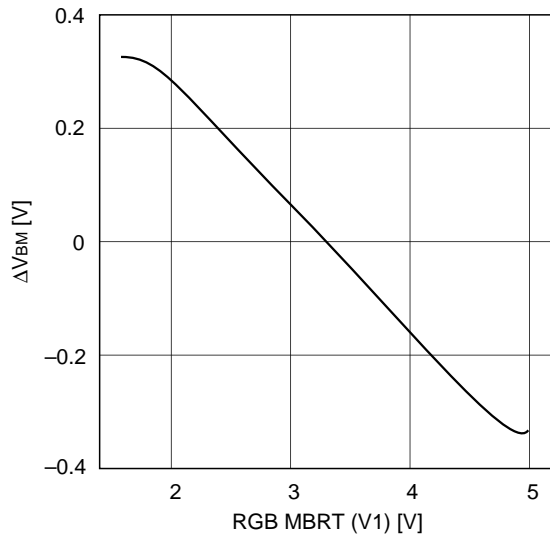

R MBRT, B MBRT adjustment range

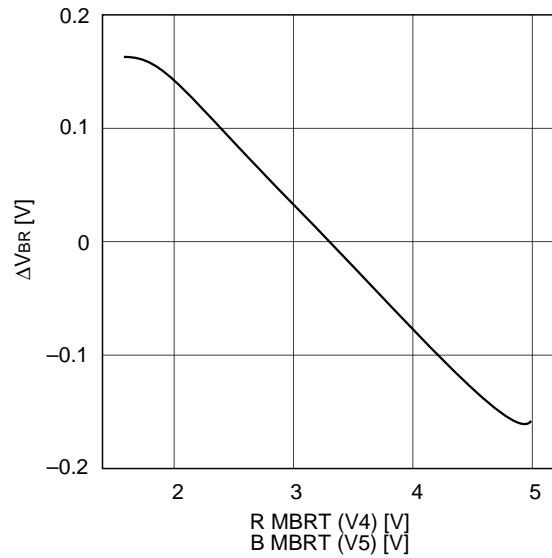

RGB SBRT adjustment range

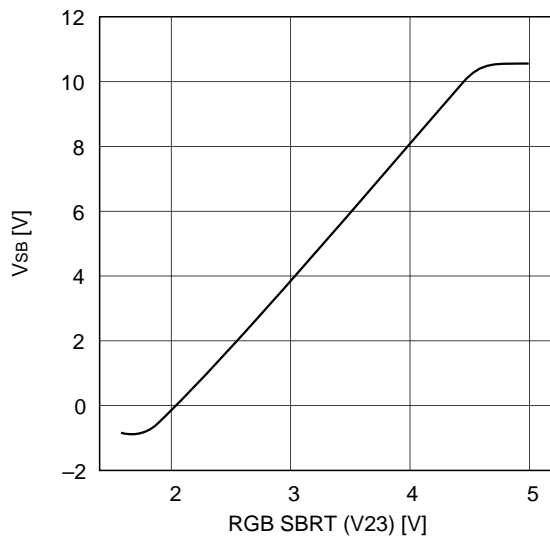

R SBRT, B SBRT adjustment range

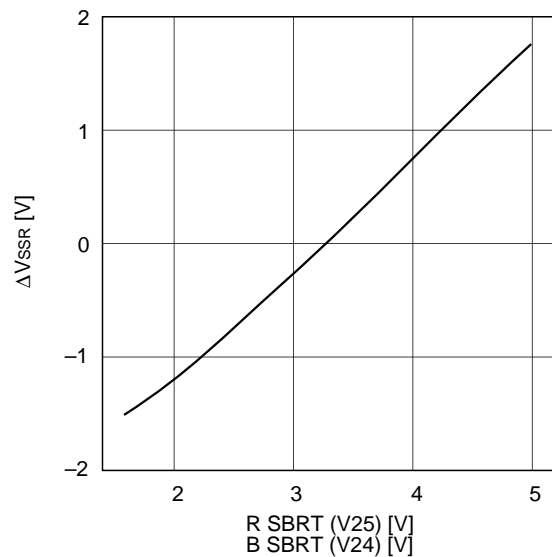

**RGB gamma black side gain adjustment range**

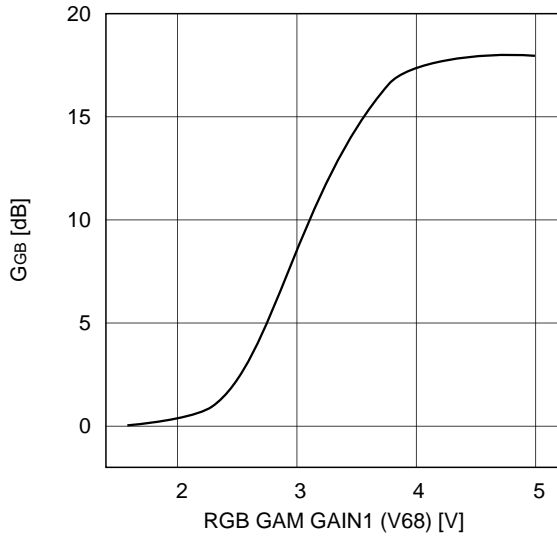

**R, B gamma black side gain adjustment range**

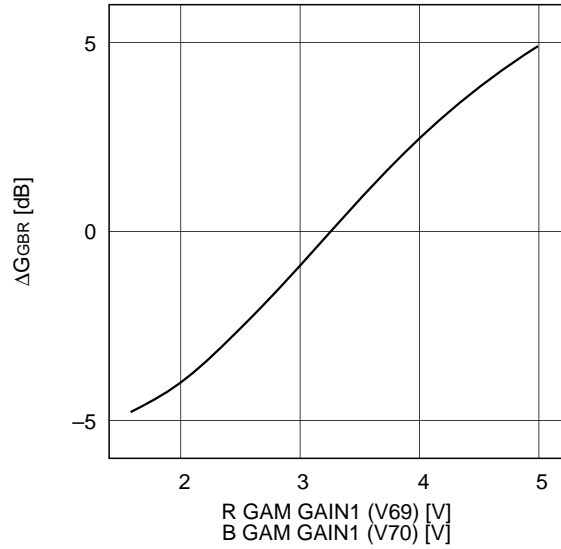

**RGB gamma white side gain adjustment range**

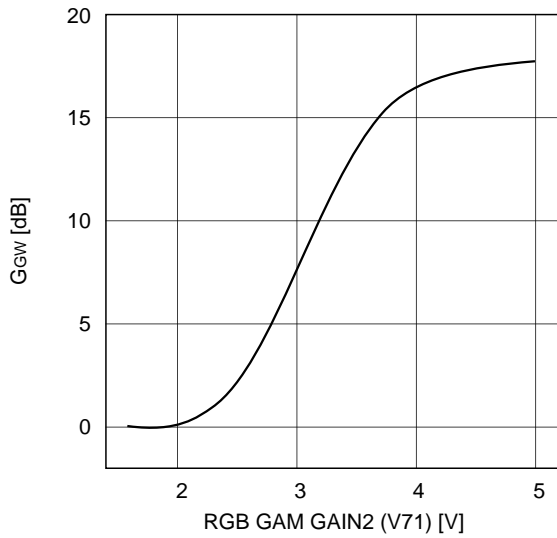

**R, B gamma white side gain adjustment range**

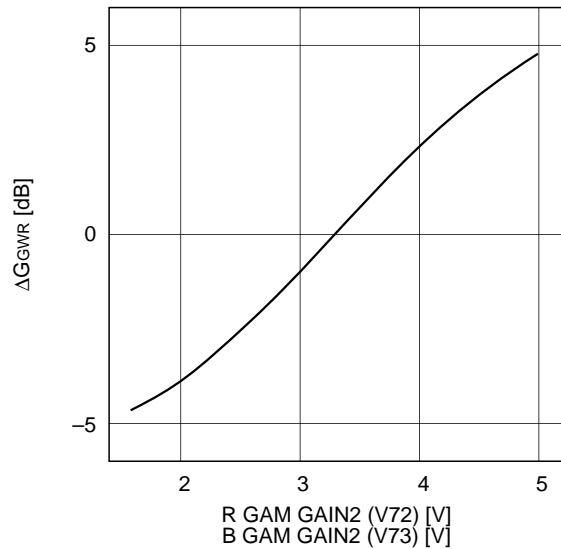

**RGB gamma black side breakpoint adjustment range**

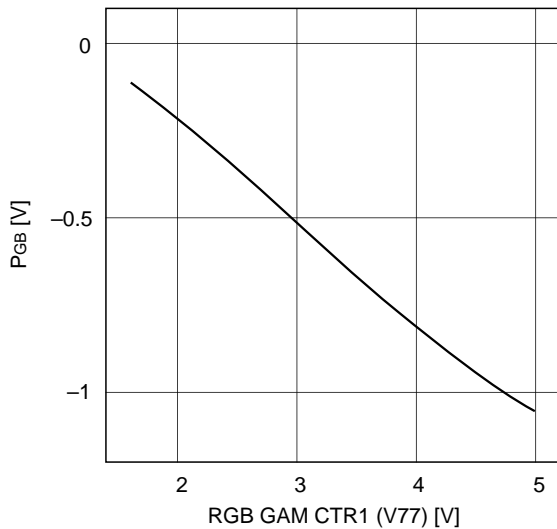

**R, B gamma black side breakpoint sub adjustment range**

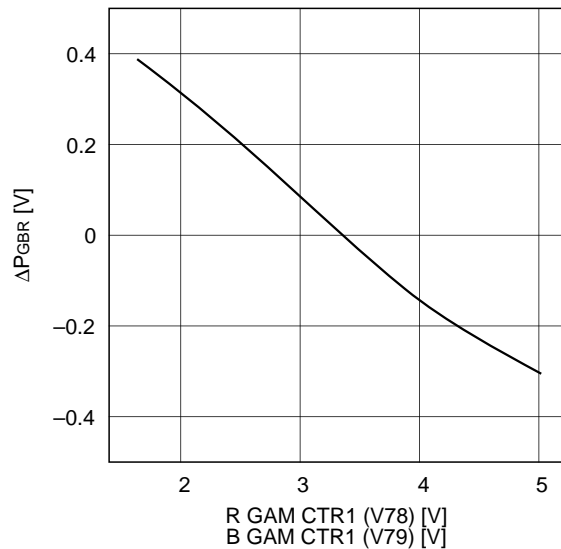

**RGB gamma white side breakpoint adjustment range**

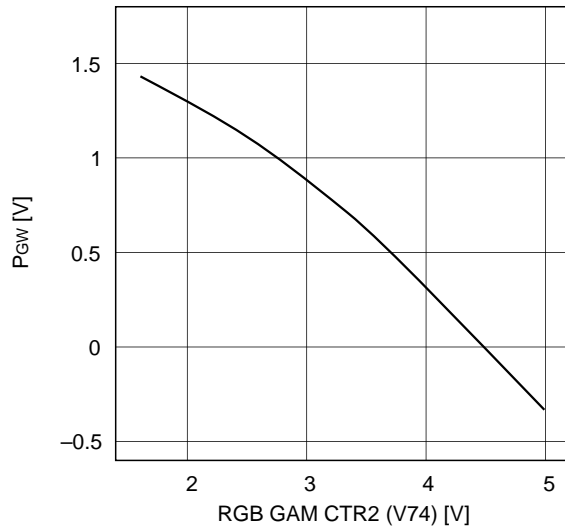

**R gamma white side breakpoint sub adjustment range**

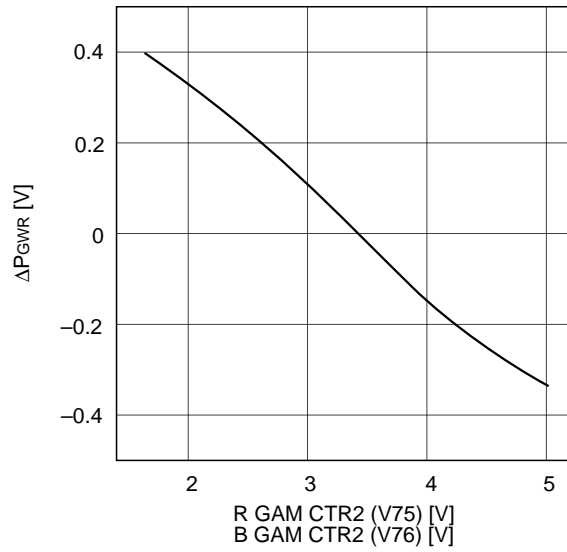

**WHT LIM adjustment range**

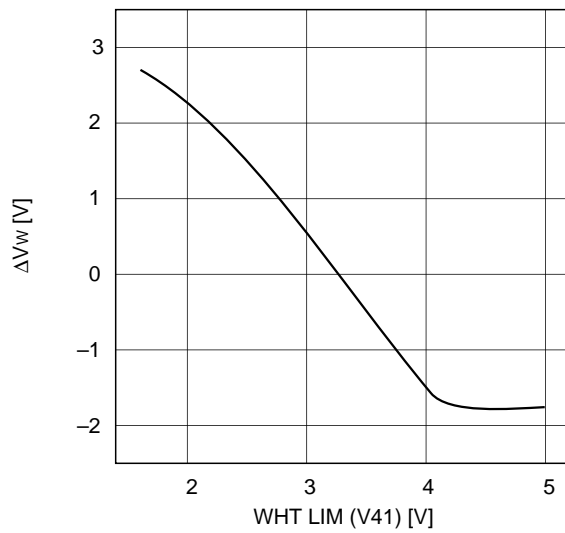

**BLK LIM adjustment range**

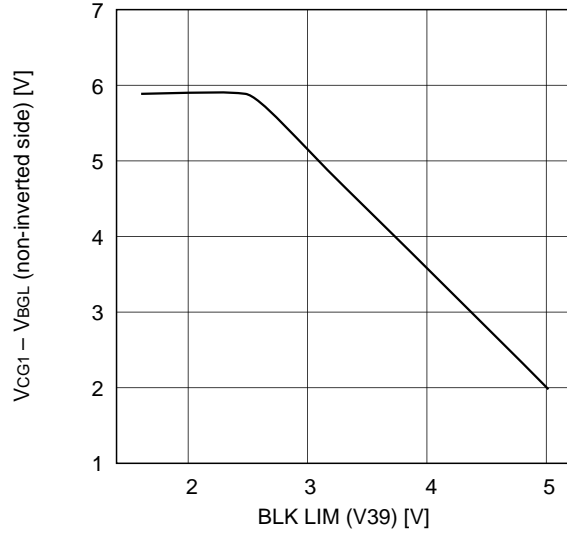

**BLK LIM adjustment range**

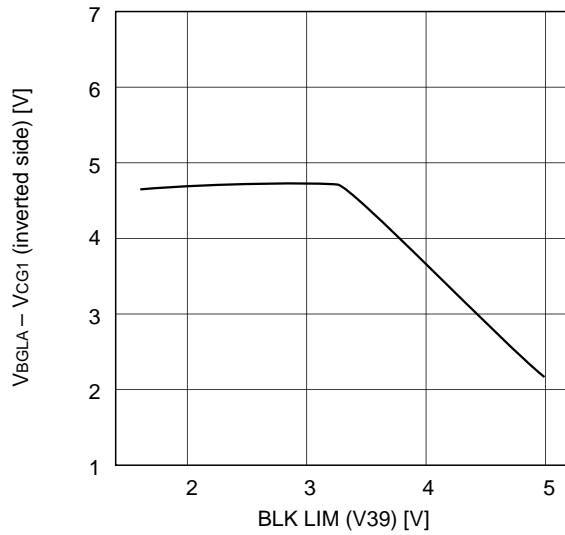

**Signal center adjustment range**

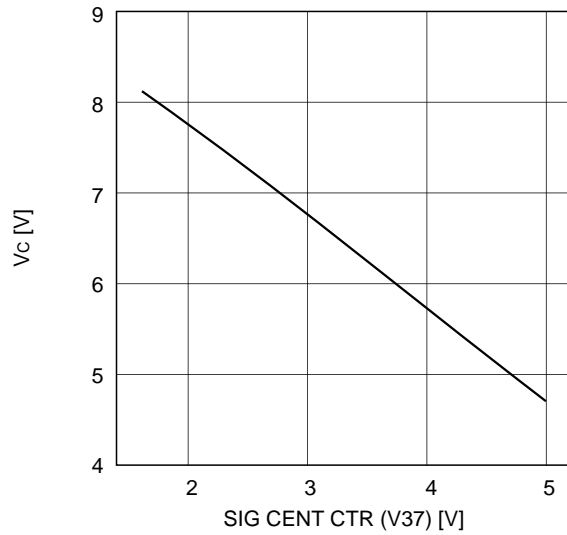

**VCOM control range**

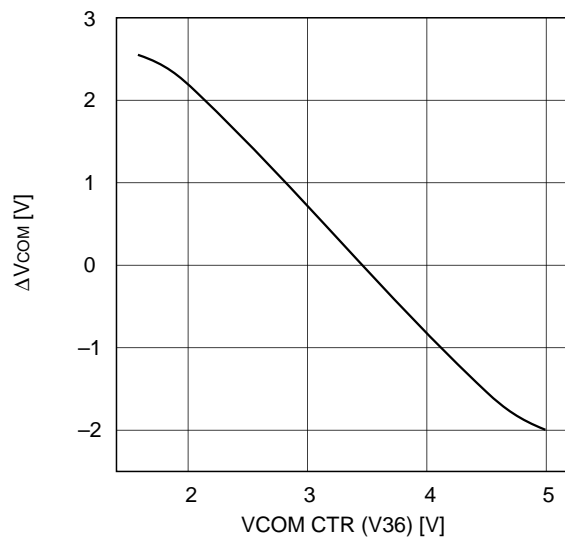

**SID amplitude control range**

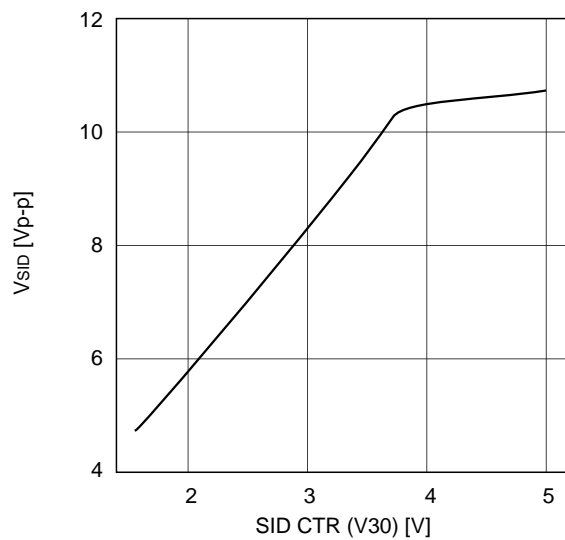

**PRG level control range**

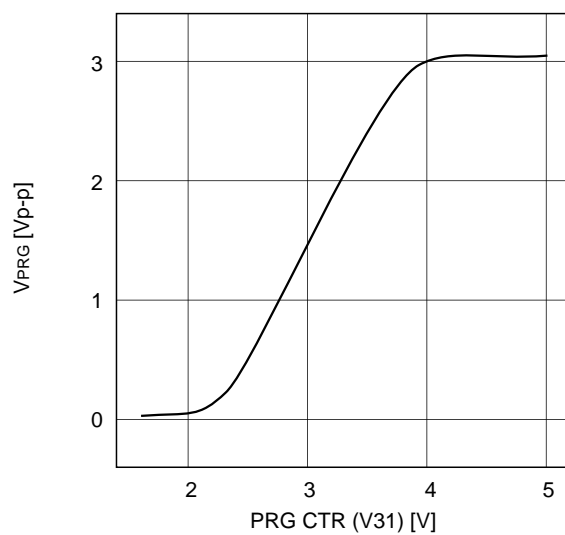

Package Outline Unit: mm

80PIN QFP (PLASTIC)

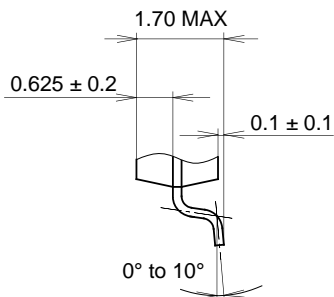
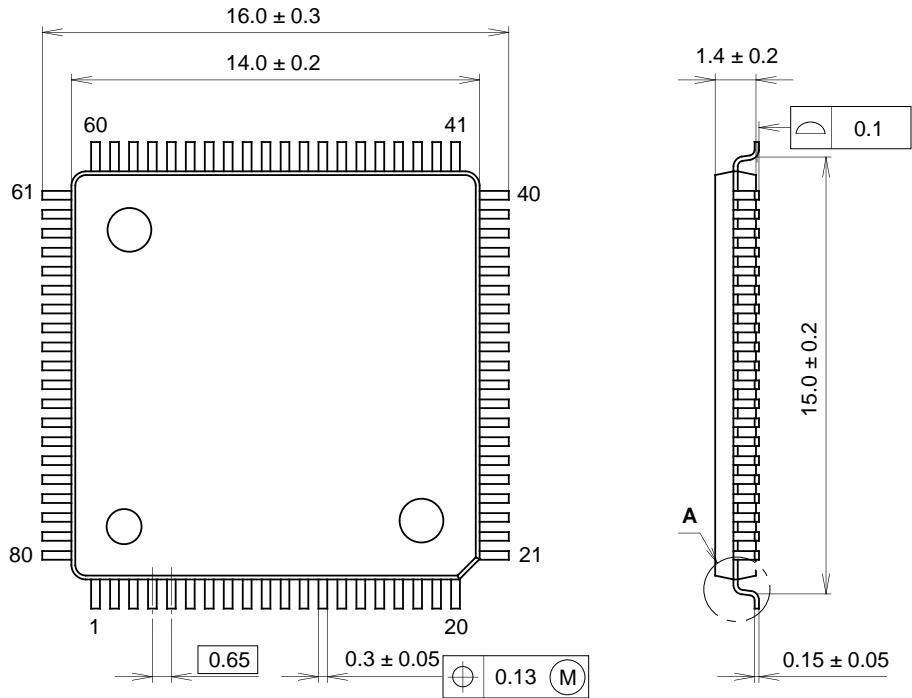

DETAIL A

SONY CODE	QFP-80P-L111
EIAJ CODE	QFP080-P-1414
JEDEC CODE	_____

PACKAGE STRUCTURE

PACKAGE MATERIAL	EPOXY RESIN
LEAD TREATMENT	SOLDER PLATING
LEAD MATERIAL	COPPER ALLOY
PACKAGE WEIGHT	0.6g



LittleDiode supplies new, hard to find or obsolete electronic components and semiconductors all over the world.

With over two million different components listed you are sure to find the part you need.

Feel free to visit us today at our online store:

[LittleDiode.com](http://LittleDiode.com)

Looking forward to providing you with the best possible service.