

# SHINDENGEN

## Schottky Rectifiers (SBD)

Dual

# D10SC6MR

## 60V 10A

### FEATURES

- Tj150°C
- P<sub>RRSM</sub> avalanche guaranteed
- Fully Isolated Molding

### APPLICATION

- Switching power supply
- DC/DC converter
- Home Appliances, Office Equipment
- Telecommunication

### OUTLINE DIMENSIONS

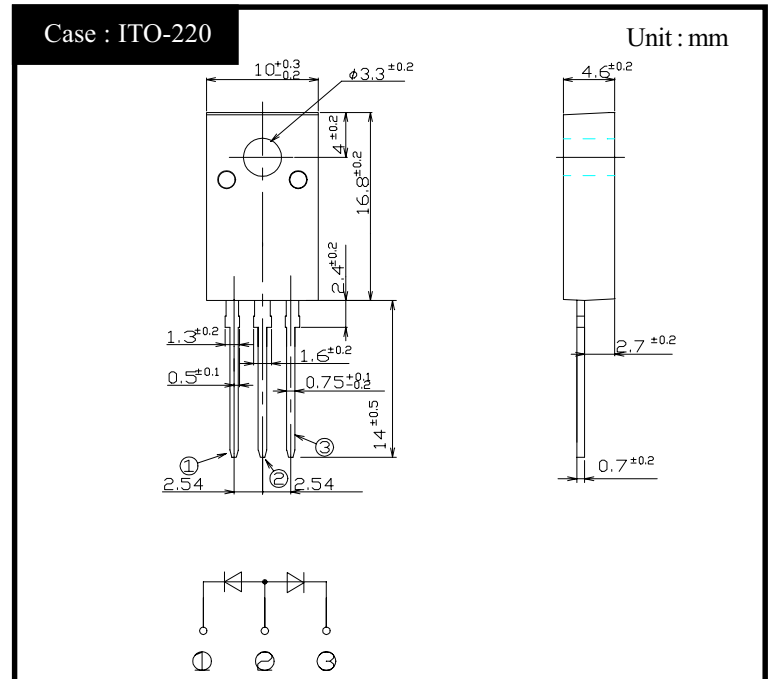

### RATINGS

#### ● Absolute Maximum Ratings (If not specified T<sub>c</sub>=25°C)

Item	Symbol	Conditions	Ratings	Unit
Storage Temperature	T <sub>stg</sub>		-40~150	°C
Operating Junction Temperature	T <sub>j</sub>		150	°C
Maximum Reverse Voltage	V <sub>RM</sub>		60	V
Repetitive Peak Surge Reverse Voltage	V <sub>RRSM</sub>	Pulse width 0.5ms, duty 1/40	65	V
Average Rectified Forward Current	I <sub>O</sub>	50Hz sine wave, R-load, Rating for each diode I <sub>O</sub> /2, T <sub>c</sub> =120°C	10	A
Peak Surge Forward Current	I <sub>FSM</sub>	50Hz sine wave, Non-repetitive 1 cycle peak value, T <sub>j</sub> =125°C	100	A
Repetitive Peak Surge Reverse Power	P <sub>RRSM</sub>	Pulse width 10 μs, Rating of per diode, T <sub>j</sub> =25°C	330	W
Dielectric Strength	V <sub>dis</sub>	Terminals to case, AC 1 minute	1.5	kV
Mounting Torque	TOR	(Recommended torque:0.3N·m)	0.5	N·m

#### ● Electrical Characteristics T<sub>c</sub>=25°C

Item	Symbol	Conditions	Ratings	Unit
Forward Voltage	V <sub>F</sub>	I <sub>F</sub> =5A, Pulse measurement, Rating of per diode	Max.0.58	V
Reverse Current	I <sub>R</sub>	V <sub>R</sub> =V <sub>RM</sub> , Pulse measurement, Rating of per diode	Max.4.5	mA
Junction Capacitance	C <sub>j</sub>	f=1MHz, V <sub>R</sub> =10V, Rating of per diode	Typ.200	pF
Thermal Resistance	θ <sub>jc</sub>	junction to case	Max.3.3	°C/W
	θ <sub>cf</sub>	case to heatsink, Mounting torque=0.5N·m	Max.1.5	

# D10SC6MR Forward Voltage

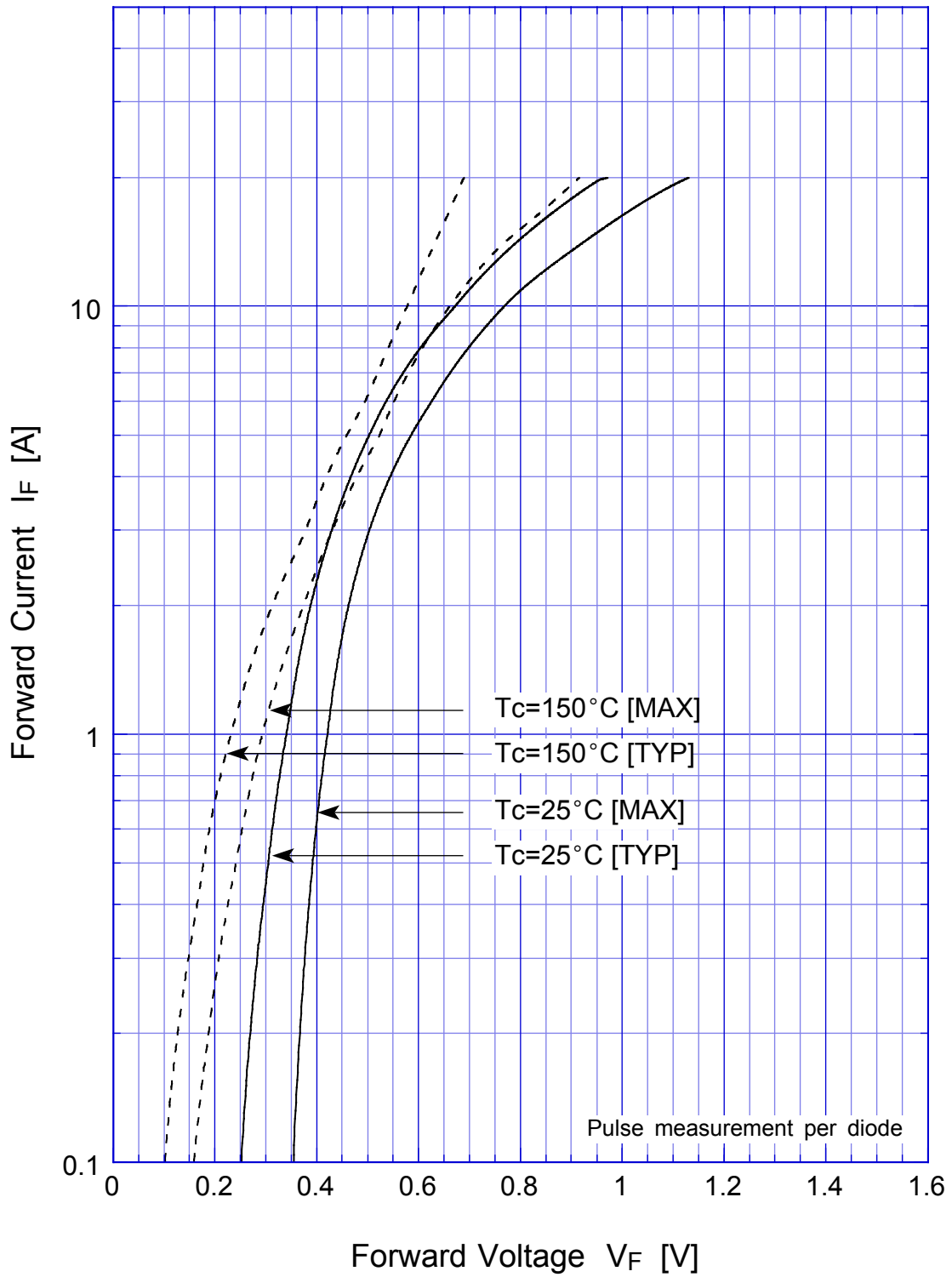

# D10SC6MR Junction Capacitance

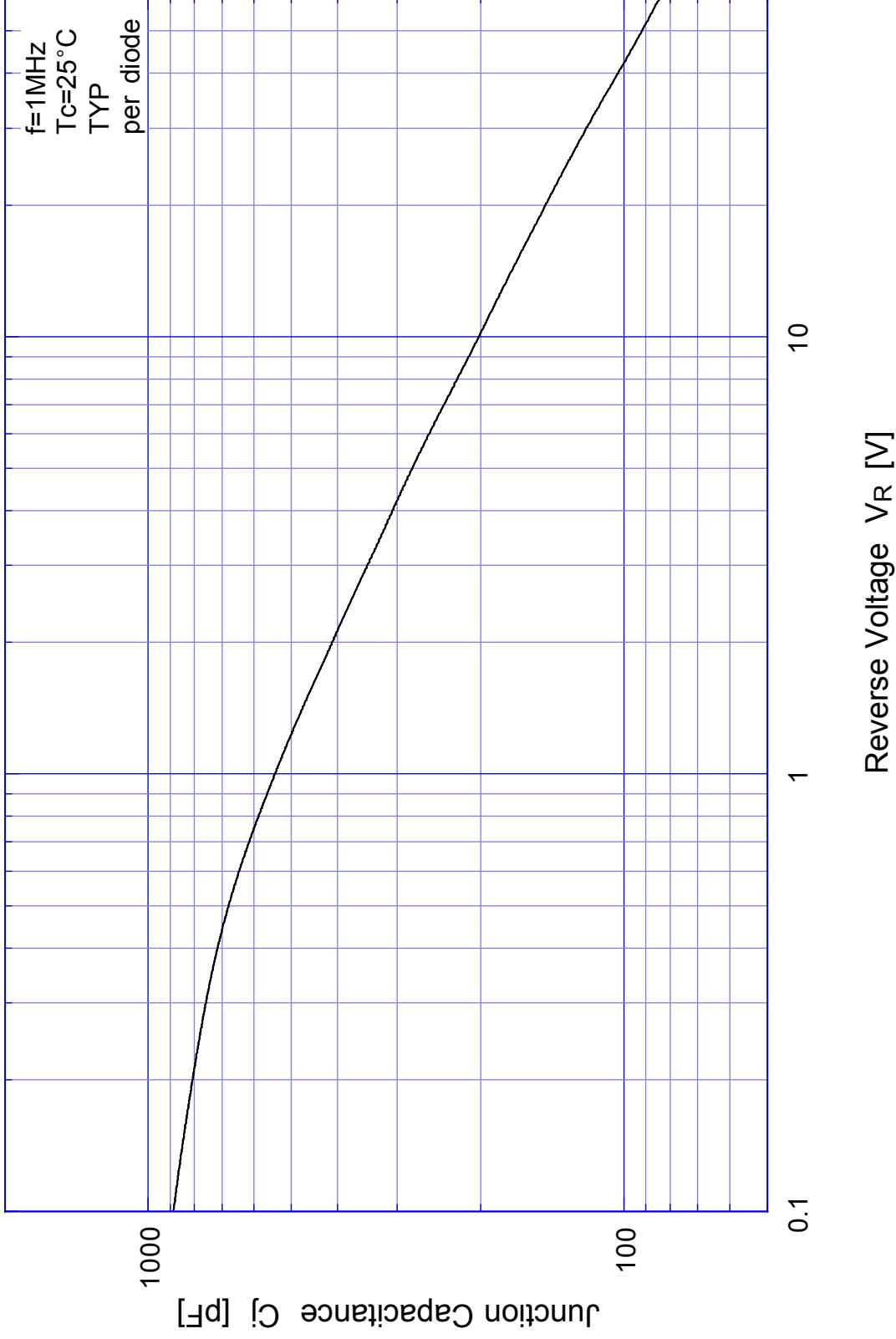

# D10SC6MR Reverse Current

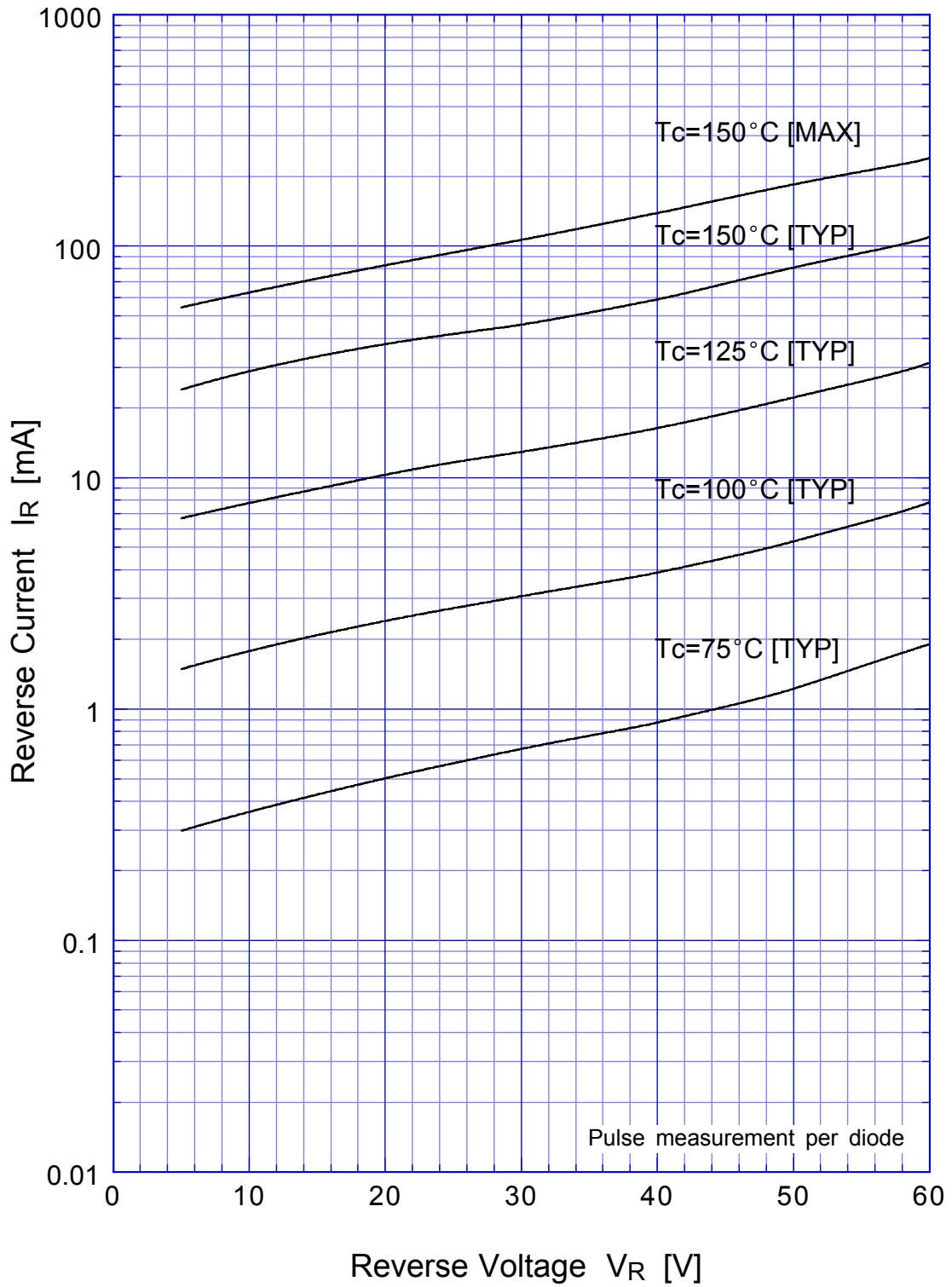

# D10SC6MR Reverse Power Dissipation

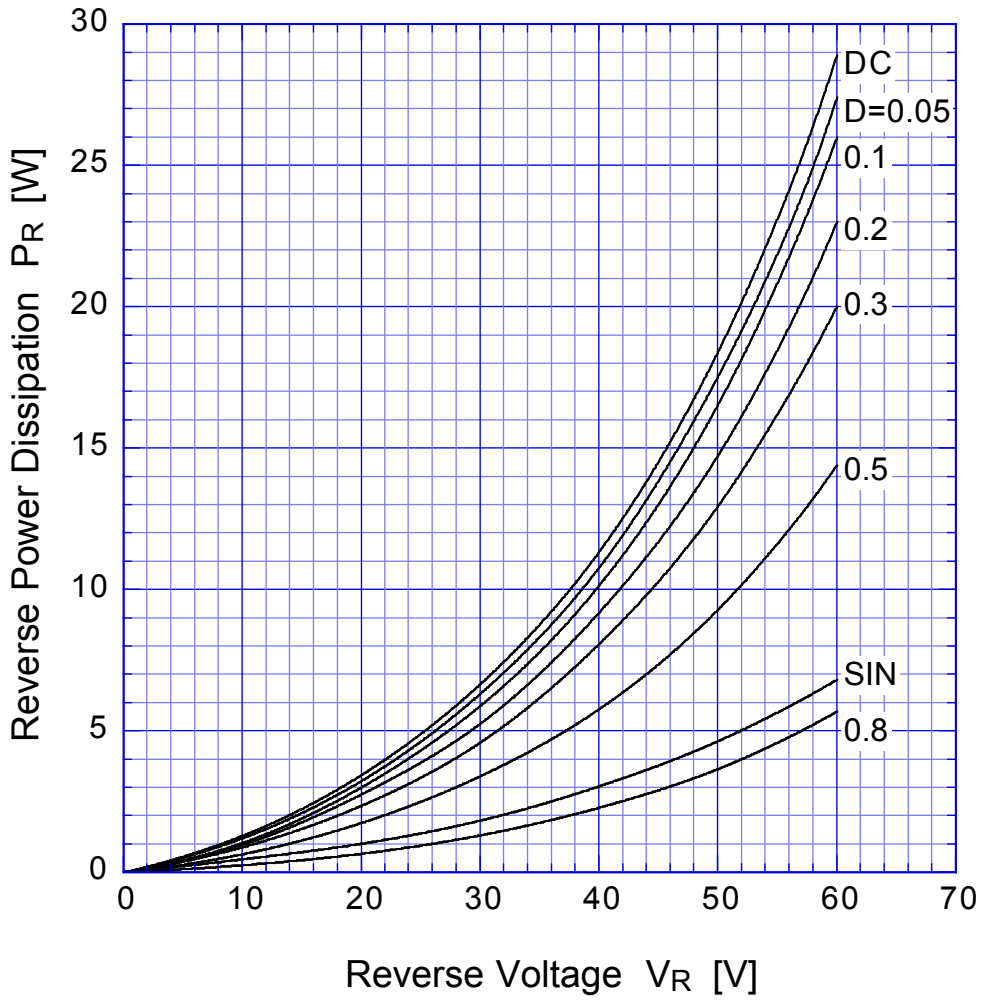

$T_j = 150^\circ\text{C}$

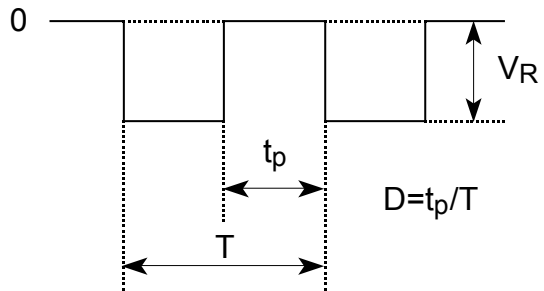

# D10SC6MR Forward Power Dissipation

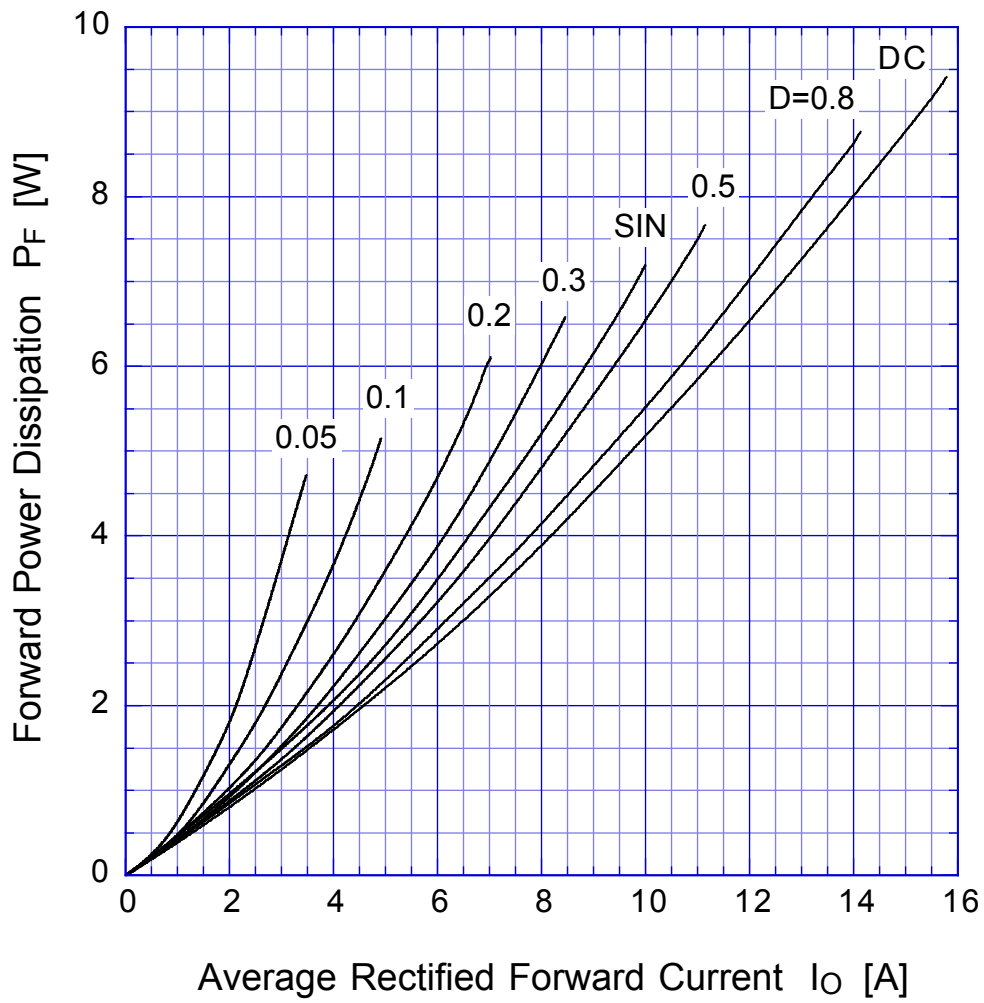

$T_j = 150^\circ\text{C}$

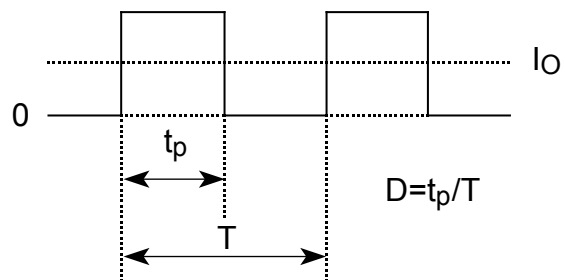

# D10SC6MR

## Derating Curve

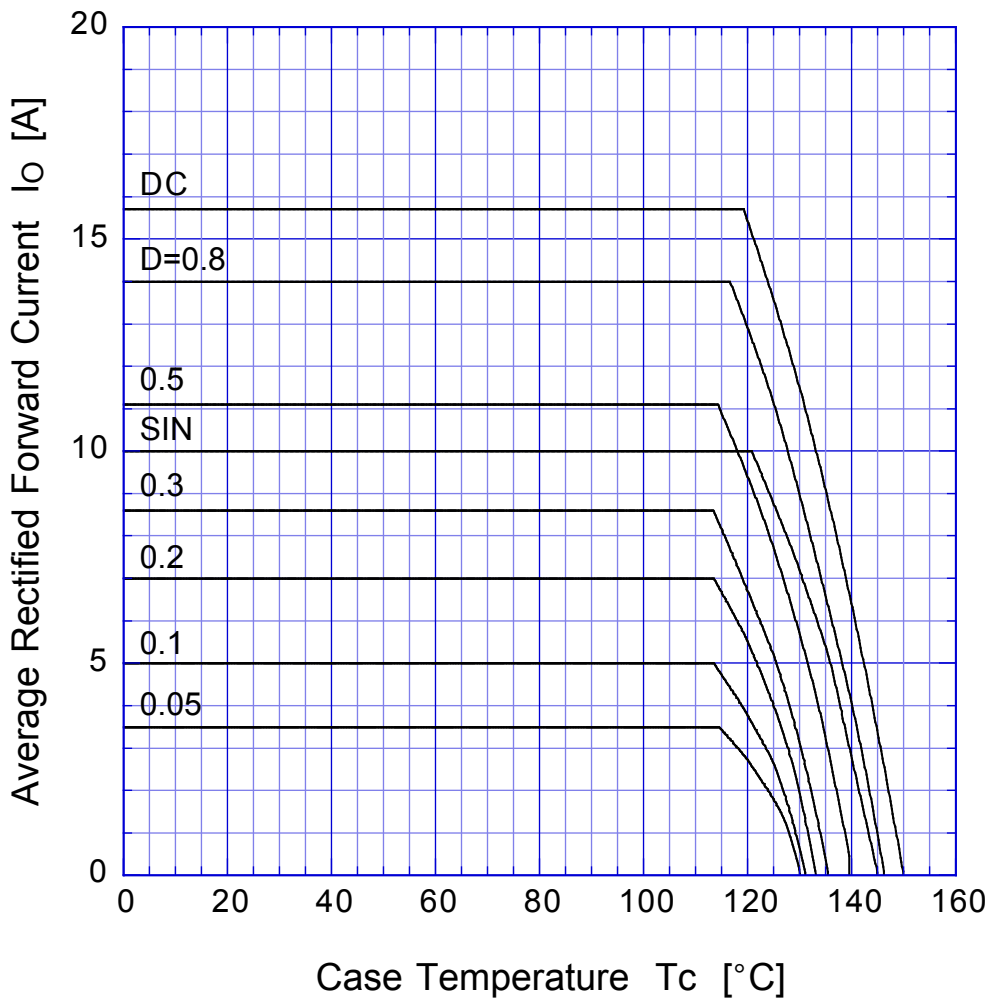

$V_R = 30V$



# D10SC6MR

## Derating Curve

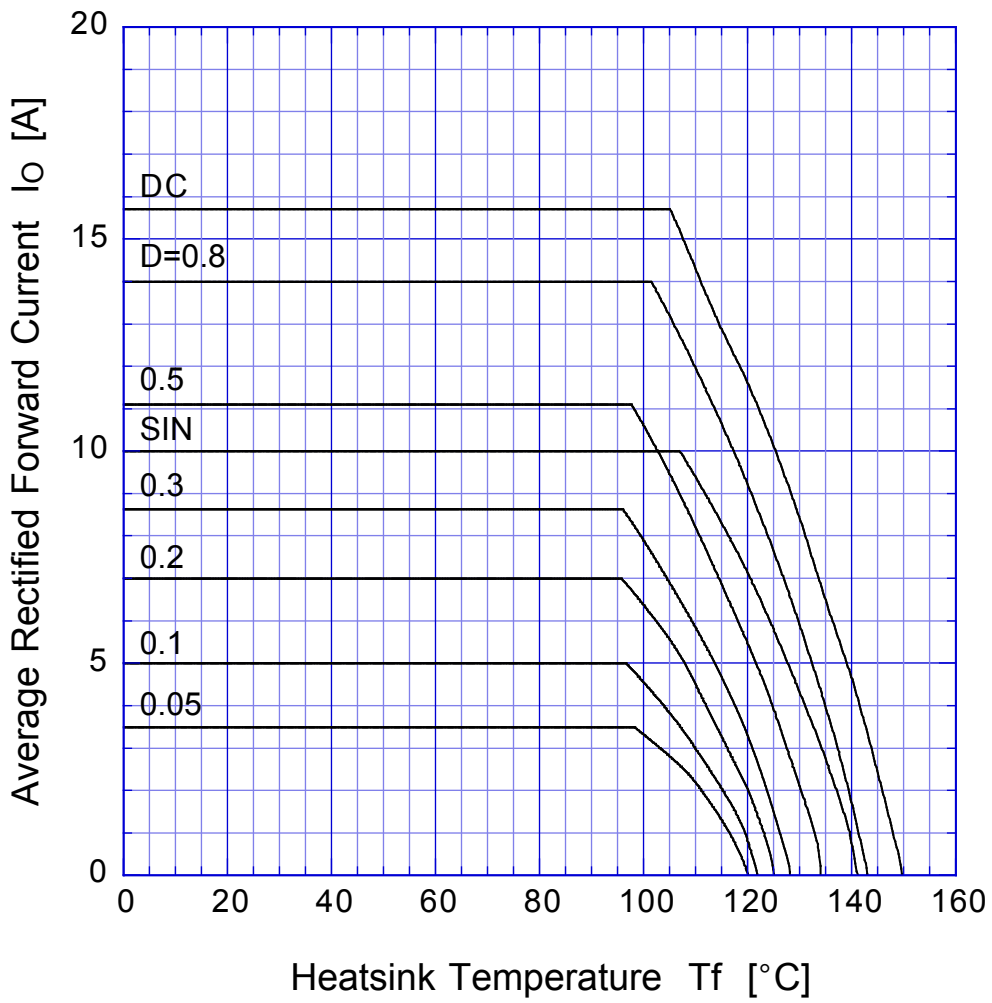

$V_R = 30V$



# D10SC6MR Peak Surge Forward Capability

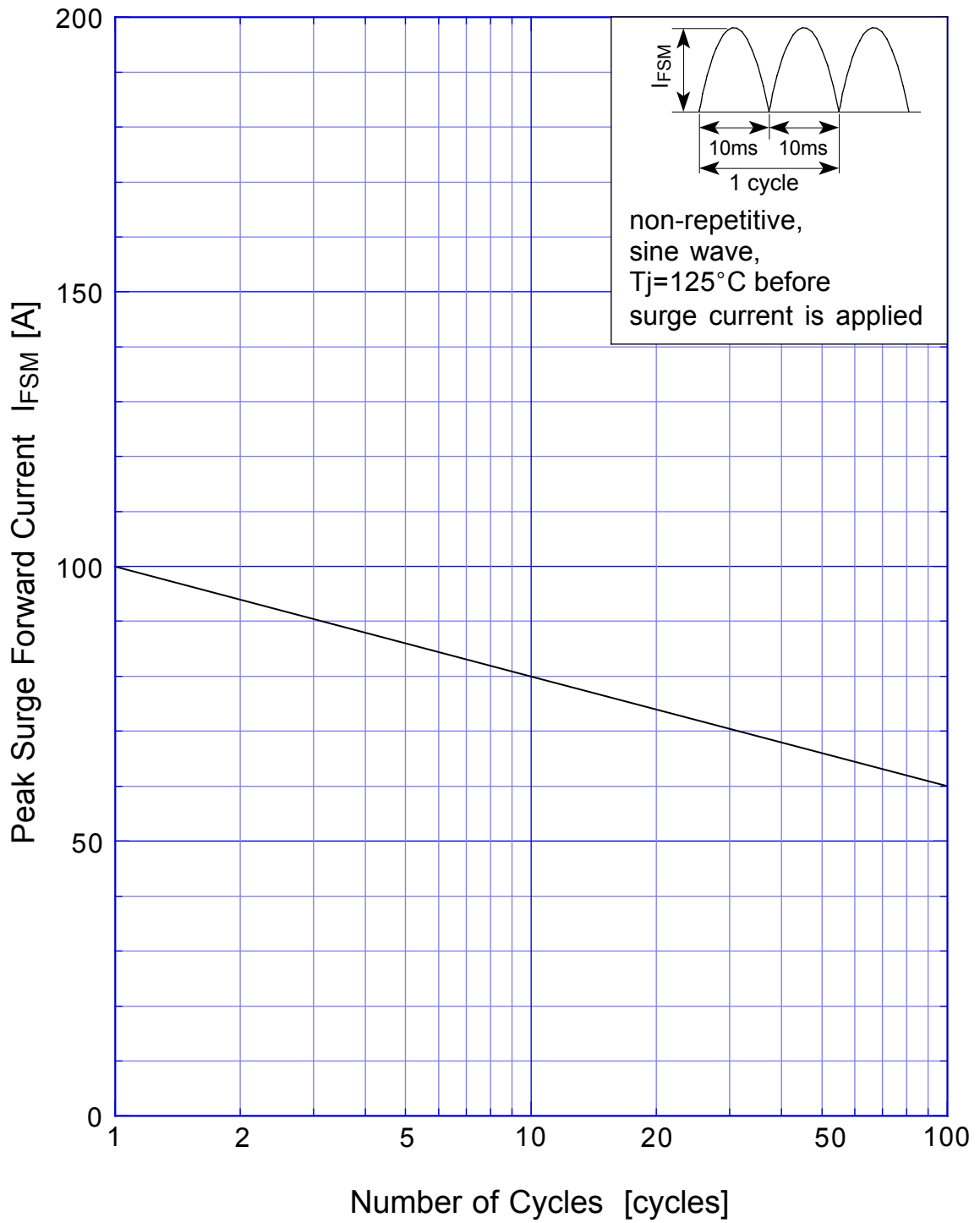

# SBD Repetitive Surge Reverse Power Derating Curve

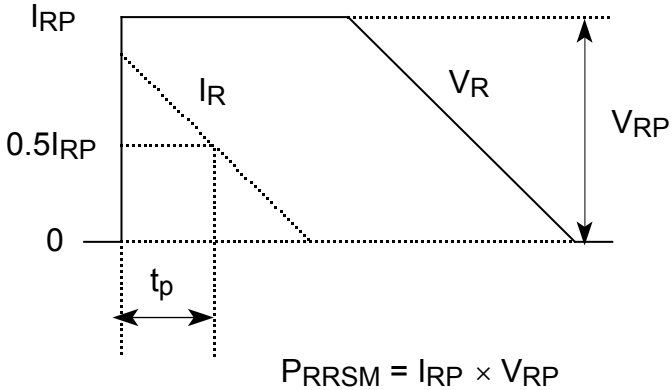

# SBD

## Repetitive Surge Reverse Power Capability

