

## D374-Type Digital Uncooled 2.5 Gbits/s Laser Module

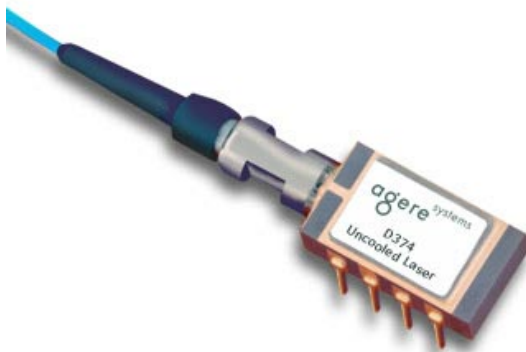

The low-profile D374-Type Laser Module is ideally suited for short- and long-reach SONET and other high-speed digital applications.

### Features

- 2.5 Gbits/s operation
- Eight-pin package suitable for SONET/SDH applications
- MQW F-P 1.3  $\mu\text{m}$  laser with single-mode fiber pigtail
- Wide operating temperature range:  $-40\text{ }^{\circ}\text{C}$  to  $+85\text{ }^{\circ}\text{C}$
- No TEC required
- 25  $\Omega$  input impedance
- High output power: typically 1.0 mW peak power coupled into single-mode fiber; 0.2 mW versions available
- Hermetically sealed active components
- Internal back-facet monitor
- Qualification program: *Telcordia Technologies*\* TA-983

\* *Telcordia Technologies* is a registered trademark of Telcordia Technologies, Inc.

### Applications

- Short-reach SONET OC-48 systems
- SDH STM-16 systems
- Telecommunications
- Secure digital data systems

### Benefits

- Easily board mounted
- Gull wing leads
- No additional heat sinks required

### Description

The D374-Type Uncooled Laser Module consists of a laser diode coupled to a single-mode fiber pigtail. The device is available in a standard, 8-pin configuration (see Figure 1 and/or Table 1) and is ideal for short-reach and other high-speed digital applications. It is developed specifically for 2.5 Gbits/s applications.

The module includes a multiquantum-well Fabry-Perot (MQW F-P) laser and an InGaAs PIN photodiode back-facet monitor in an epoxy-free, hermetically sealed package.

**Description** (continued)

The device characteristics listed in this document are met at 1.0 mW output power. Higher- or lower-power operation is possible. Under conditions of a fixed photodiode current, the change in optical output is typically  $\pm 0.5$  dB over an operating temperature range of  $-40$  °C to  $+85$  °C.

This device incorporates the new Laser 2000 manufacturing process developed by the Optoelectronic unit of Agere Systems Inc. Laser 2000 is a low-cost platform that targets high-volume manufacturing and tight product distributions on all optical subassemblies. This platform incorporates an advanced optical design that is produced on a highly automated production line. The Laser 2000 platform is qualified for the central office

and uncontrolled environments, and can be used for applications requiring high performance and low cost.

**Table 1. Pin Descriptions**

Pin Number	Connection
1	NC/reserved
2	Case ground
3	NC/reserved
4	PD cathode
5	PD anode
6	Laser diode anode (+)
7	Laser RF input cathode (-), 25 $\Omega$
8	Laser diode anode (+)

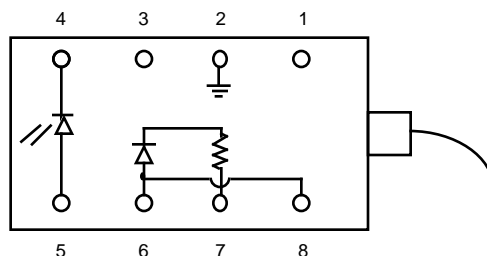

1-900

**Figure 1. D374-Type Digital Uncooled 2.5 Gbits/s Laser Module Schematic, Top View**

**Absolute Maximum Ratings**

Stresses in excess of the absolute maximum ratings can cause permanent damage to the device. These are absolute stress ratings only. Functional operation of the device is not implied at these or any other conditions in excess of those given in the operations sections of the data sheet. Exposure to absolute maximum ratings for extended periods can adversely affect device reliability.

Parameter	Symbol	Min	Max	Unit
Maximum Peak Laser Drive Current or Maximum Fiber Power*	$I_{OP}$ $P_{MAX}$	—	150 10	mA mW
Peak Reverse Laser Voltage:				
Laser	$V_{RL}$	—	2	V
Monitor	$V_{RD}$	—	20	V
Monitor Forward Current	$I_{FD}$	—	2	mA
Operating Case Temperature Range	$T_C$	-40	85	°C
Storage Case Temperature Range	$T_{stg}$	-40	85	°C
Lead Soldering Temperature/Time	—	—	260/10	°C/s
Relative Humidity (noncondensing)	RH	—	85	%

\* Rating varies with temperature.

## Handling Precautions

**Caution:** This device is susceptible to damage as a result of electrostatic discharge (ESD). Take proper precautions during both handling and testing. Follow guidelines such as JEDEC Publication No. 108-A (Dec. 1988).

Although protection circuitry is designed into the device, take proper precautions to avoid exposure to ESD.

## Electrical/Optical Characteristics

**Table 2. Electrical/Optical Characteristics** (over operating temperature range unless otherwise noted)

Parameter	Symbol	Test Conditions	Min	Typ	Max	Unit
Operating Temperature Range	T	—	-40	—	85	°C
Optical Output Power*	P <sub>F</sub>	CW, nominal	—	1	—	mW
Threshold Current	I <sub>TH</sub>	T = 25 °C	4.5	9	15	mA
		T = full range	1	—	45	mA
Modulation Current	I <sub>MOD</sub>	CW, P <sub>F</sub> = 1.0 mW, T = 25 °C	10	15	20	mA
		CW, I <sub>MON</sub> = constant, T = full range	8	—	35	mA
Slope Efficiency <sup>†</sup>	SE	CW, P <sub>F</sub> = 1.0 mW, T = 25 °C	50	75	100	μW/mA
Center Wavelength	λ <sub>c</sub>	P <sub>F</sub> = 1.0 mW, CW	1270	—	1350	nm
RMS Spectral Width	Δλ	P <sub>F</sub> = 1.0 mW, 155 Mbits/s	—	2	3	nm
Tracking Error	TE	I <sub>MON</sub> = constant, CW	—	0.5	±1	dB
Spontaneous Emission	P <sub>TH</sub>	I = (0.9) I <sub>TH</sub>	—	—	50	μW
Rise/Fall Times	t <sub>R</sub> , t <sub>F</sub>	10%—90% pulse T = 25 °C	—	0.125	0.150	ns
Forward Voltage	V <sub>F</sub>	At bias coil	—	1.1	1.6	V
Input Impedance	R	—	—	25	—	Ω
Monitor Current	I <sub>MON</sub>	V <sub>R</sub> <sup>‡</sup> = 5 V	150	—	750	μA
Monitor Dark Current	I <sub>D</sub>	V <sub>R</sub> <sup>‡</sup> = 5 V	—	10	200	nA
Wavelength Temperature Coefficient	—	—	—	0.4	0.5	nm/°C

\* Higher and lower powers available. See Table 4 for more information.

† The slope efficiency is used to calculate the modulation current for a desired output power. This modulation current plus the threshold current comprise the total operating current for the device.

‡ V<sub>R</sub> = reverse voltage.

Characteristic Curve

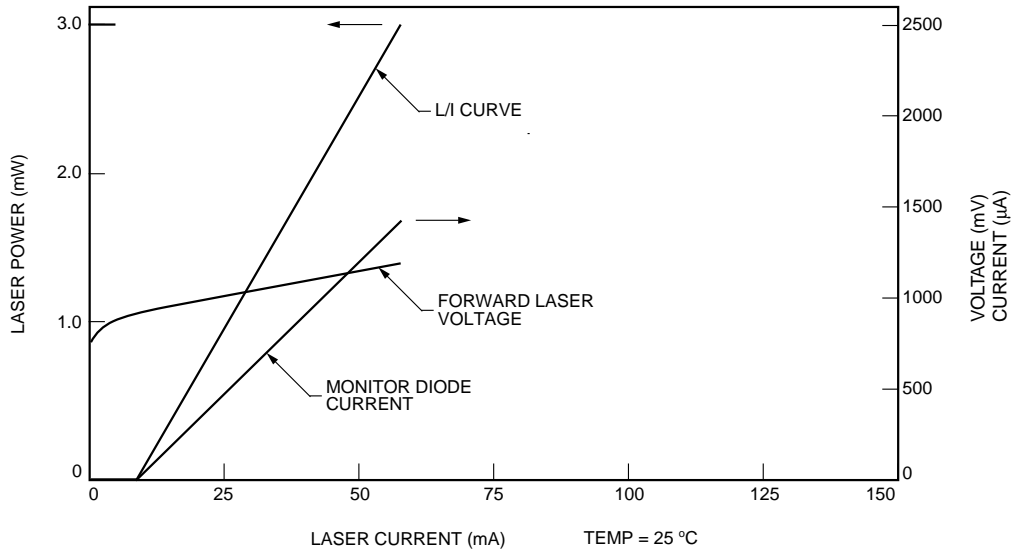

Figure 2. Typical D374-Type Laser Module L/I Curve

1-884 (C)

Qualification Information

The D374-Type Laser Module has completed and passed the following qualification tests and meets the intent of *Telcordia Technologies* TR-NWT-000468 for interoffice environments and TA-TSY-000983 for outside plant environments.

Table 3. D374-Type Laser Module Qualification Test Plan

Qualification Test	Conditions	Sample Size	Reference
Mechanical Shock	500 G	11	MIL-STD-883, Method 2002
Vibration	20 g, 20 Hz—2,000 Hz	11	MIL-STD-883, Method 2007
Solderability	—	11	MIL-STD-883, Method 2007
Thermal Shock	Delta T = 100 °C	11	MIL-STD-883, Method 2003
Fiber Pull	1 kg; 3 times	11	Bellcore 983
Accelerated (biased) Aging	85 °C, 5,000 hrs.	25	<i>Telcordia Technologies</i> 983, Section 5.18
High-temperature Storage	85 °C, 2,000 hrs.	11	<i>Telcordia Technologies</i> 983
Temperature Cycling	500 cycles	11	<i>Telcordia Technologies</i> 983, Section 5.20
Cyclic Moisture Resistance	10 cycles	11	<i>Telcordia Technologies</i> 983, Section 5.23
Damp Heat	40 °C, 95% RH, 1344 hrs.	11	MIL-STD-202, Method 103
Internal Moisture	<5,000 ppm water vapor	11	MIL-STD-883, Method 1018
Flammability	—	—	TR357, Section 4.4.2.5
ESD Threshold	—	6	<i>Telcordia Technologies</i> 983, Section 5.22

### Outline Diagram

Dimensions are in inches and (millimeters).

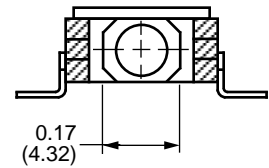
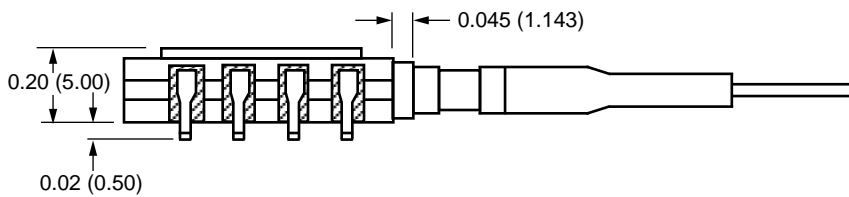
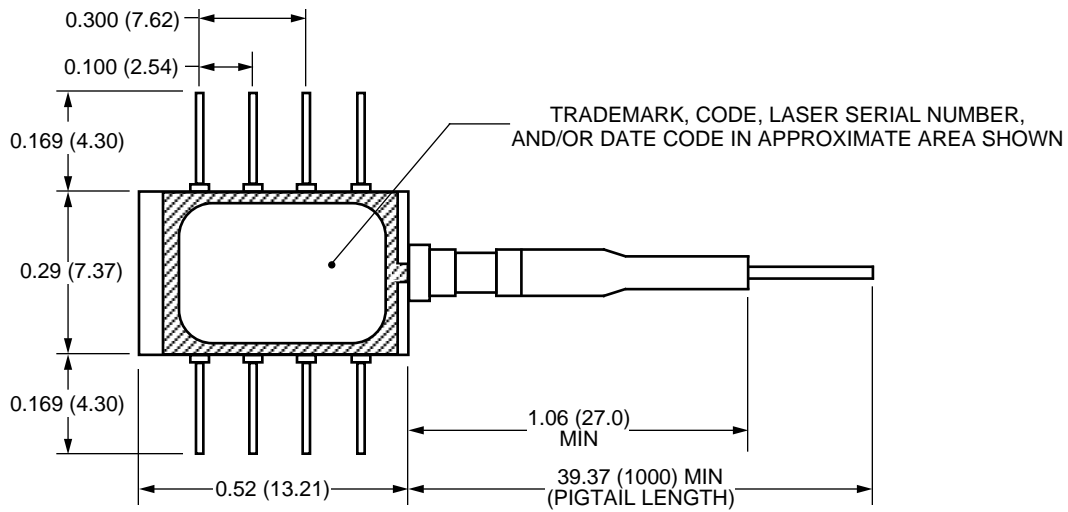

1.925.e

## Laser Safety Information

### Class IIIb Laser Product

FDA/CDRH Class IIIb laser product. All versions are Class IIIb laser products per CDRH, 21 CFR 1040 Laser Safety requirements. All versions are Class 3B laser products per *IEC*\* 60825-1:1993. The device has been classified with the FDA under accession number 8720010.

This product complies with 21 CFR 1040.10 and 1040.11.

8.3  $\mu\text{m}$  single-mode pigtail with optional connector.

Wavelength = 1.3  $\mu\text{m}$ .

Maximum power = 10 mW.

Because of size constraints, laser safety labeling is not affixed to the module but attached to the outside of the shipping carton.

Product is not shipped with power supply.

**Caution: Use of controls, adjustments, and procedures other than those specified herein may result in hazardous laser radiation exposure.**

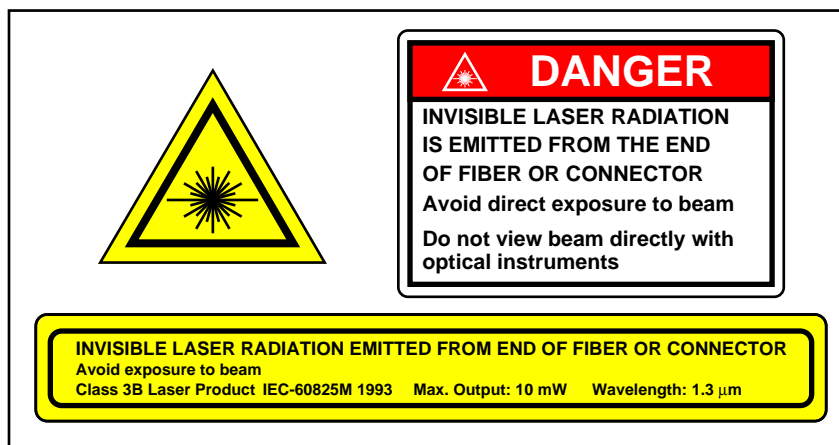

\* *IEC* is a registered trademark of The International Electrotechnical Commission.

## Ordering Information

Table 4. Ordering Information

<b>Code</b>	<b>Comcode</b>	<b>Pfiber</b>	<b>Connector</b>
D374-10A	108200601	1.0 mW	SC-PC
D374-10F	108226911	1.0 mW	FC-PC
D374-02A	108321456	0.2 mW	SC-PC
D374-02F	108321464	0.2 mW	FC-PC
D374-02N	108320144	0.2 mW	None

---

For additional information, contact your Agere Systems Account Manager or the following:

INTERNET: <http://www.agere.com>

E-MAIL: [docmaster@micro.lucent.com](mailto:docmaster@micro.lucent.com)

N. AMERICA: Agere Systems Inc., 555 Union Boulevard, Room 30L-15P-BA, Allentown, PA 18109-3286  
**1-800-372-2447**, FAX 610-712-4106 (In CANADA: **1-800-553-2448**, FAX 610-712-4106)

ASIA PACIFIC: Agere Systems Singapore Pte. Ltd., 77 Science Park Drive, #03-18 Cintech III, Singapore 118256  
**Tel. (65) 778 8833**, FAX (65) 777 7495

CHINA: Agere Systems (Shanghai) Co., Ltd., 33/F Jin Mao Tower, 88 Century Boulevard Pudong, Shanghai 200121 PRC  
**Tel. (86) 21 50471212**, FAX (86) 21 50472266

JAPAN: Agere Systems Japan Ltd., 7-18, Higashi-Gotanda 2-chome, Shinagawa-ku, Tokyo 141, Japan  
**Tel. (81) 3 5421 1600**, FAX (81) 3 5421 1700

EUROPE: Data Requests: DATALINE: **Tel. (44) 7000 582 368**, FAX (44) 1189 328 148  
Technical Inquiries: OPTOELECTRONICS MARKETING: **(44) 1344 865 900** (Ascot UK)

---

Agere Systems Inc. reserves the right to make changes to the product(s) or information contained herein without notice. No liability is assumed as a result of their use or application.



LittleDiode supplies new, hard to find or obsolete electronic components and semiconductors all over the world.

With over two million different components listed you are sure to find the part you need.

Feel free to visit us today at our online store:

[LittleDiode.com](http://LittleDiode.com)

Looking forward to providing you with the best possible service.