

DFA20 SERIES SINGLE OUTPUT

DESCRIPTION

The compact DFA20 Series provides power densities up to 11 watts per cubic inch (0.67 watts per cm³). Ideal for battery operated industrial, medical control and remote data collection systems, this converter has fully filtered inputs and outputs. Complete overload protection with independent pulse-by-pulse current limiting and an overtemperature shutdown ensures reliable system operation. The output of the converter is electrically isolated, thereby allowing the output to be configured as a positive or negative output voltage.

FEATURES

- Remote ON/OFF and TRIM
- Overcurrent Protection and Thermal Shutdown
- Efficiencies to 83%
- 700V Isolation, Up to 1544V on 48V Converters
- Power Density up to 11 Watts per Cubic Inch
- Five-Side Shielded Case
- Extended Range Input (2:1)

Selection Chart				
Model	Input Range VDC (4)		Output VDC	Output mA
	Min	Max		
DFA20E12S3.3	9	18	3.3	4000
DFA20E12S5	9	18	5	4000
DFA20E12S12	9	18	12	1700
DFA20E12S15	9	18	15	1400
DFA20E24S3.3	18	36	3.3	4000
DFA20E24S5	18	36	5	4000
DFA20E24S12	18	36	12	1700
DFA20E24S15	18	36	15	1400
DFA20E48S3.3	36	72	3.3	4000
DFA20E48S5	36	72	5	4000
DFA20E48S12	36	72	12	1700
DFA20E48S15	36	72	15	1400

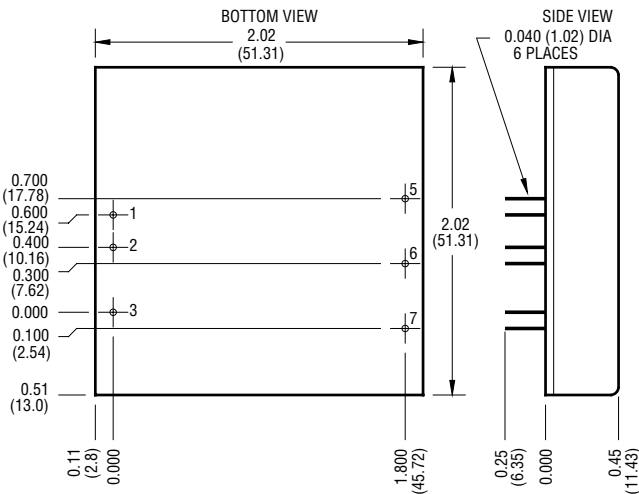

Mechanical tolerances unless otherwise noted:
 X.XX dimensions: ±0.020 inches
 X.XXX dimensions: ±0.005 inches

NOTES

- (1) All parameters measured at T_c = 25°C, nominal input voltage and full rated load unless otherwise noted. Refer to the Technical Reference Section for the definition of terms, measurement circuits and other information.
- (2) The Case is tied to the -Input, Pin 2.
- (3) The functional temperature range is intended to give an additional data point for use in evaluating this power supply. At the low functional temperature the power supply will function with no side effects, however, sustained operation at the high functional temperature will reduce expected operational life. The data sheet specifications are not guaranteed beyond the case operating range.
- (4) The case thermal impedance is specified as the case temperature rise over ambient per package watt dissipated.

General Specifications (1)			
All Models			Units
ON/OFF Function			
ON Logic Level or Pin Open	MIN	>1.6	VDC
OFF Logic Level or Tie Pin to -Input	MAX	<0.7	VDC
Open Circuit Voltage	TYP	2.5	VDC
Input Resistance	TYP	20	Kohms
Converter Idle Current ON/OFF Pin Low			
12V Models	TYP	3	mA
24V and 48V Models	TYP	5	mA
Isolation (2)			
Isolation Voltage			
Input to Output 12V, 24V	MIN	700	VDC
Input to Output 48V	MIN	1544	VDC
10µA Leakage			
Input to Output Capacitance	TYP	290	pF
Output Trim Function			
Trim Range	MIN	±5	%
Input Resistance	MIN	10	Kohms
Open Circuit Voltage	TYP	2.5	VDC
Environmental			
Case Operating Range, T _c No Derating	MIN	-40	°C
	MAX	85	°C
Case Functional Range (3)	MIN	-50	°C
	MAX	100	°C
Storage Range	MIN	-55	°C
	MAX	105	°C
Thermal Shutdown Case Temperature	TYP	105	°C
Thermal Impedance (4)	TYP	9.5	°C/Watt
General			
MTBF (Calculated)	TYP	800,000	HRS
Unit Weight	TYP	2.3 / 65	oz / gm
Chassis Mounting Kit 12V, 24V			CM2B1
48V			CM2A1

Pin	Function
1	+INPUT
2	-INPUT
3	ON/OFF
4	NO PIN
5	+OUT
6	-OUT
7	TRIM

DFA20 SERIES – SINGLE OUTPUT

Input Parameters (1)								
Model		DFA20E12S3.3	DFA20E12S5	DFA20E12S12	DFA20E12S15	DFA20E24S3.3	DFA20E24S5	Units
Voltage Range	MIN	9				18		VDC
	MAX	18				36		
Reflected Ripple (2)	TYP	350				140		mA _{pp}
	TYP	100				40		mA _{rms}
Input Current Full Load	TYP	1.46	2.12	2.15	2.21	0.70	1.01	A
	No Load	16	16	16	16	10	10	mA
Efficiency	TYP	76	79	79	79	80	83	%
Switching Frequency	TYP	220						kHz
Maximum Input Overvoltage, 100ms Maximum	MAX	24				45		VDC
Turn-on Time, 1% Output Error	TYP	10						ms
Model		DFA20E24S12	DFA20E24S15	DFA20E48S3.3	DFA20E48S5	DFA20E48S12	DFA20E48S15	Units
Voltage Range	MIN	18			36			VDC
	MAX	36			72			
Reflected Ripple (2)	TYP	140			90			mA _{pp}
	TYP	40			25			mA _{rms}
Input Current No Load	TYP	10	10	8	8	8	8	mA
	Full Load	1.00	1.02	0.35	0.50	0.51	0.51	A
Efficiency	TYP	85	86	80	83	84	85	%
Switching Frequency	TYP	220						kHz
Maximum Input Overvoltage, 100ms Maximum	MAX	45			85			VDC
Turn-on Time, 1% Output Error	TYP	10						ms

Output Parameters (1)						
Model		DFA20E12S3.3 DFA20E24S3.3 DFA20E48S3.3	DFA20E12S5 DFA20E24S5 DFA20E48S5	DFA20E12S12 DFA20E24S12 DFA20E48S12	DFA20E12S15 DFA20E24S15 DFA20E48S15	Units
Output Voltage		3.33	5	12	15	VDC
Output Voltage Accuracy	MIN	3.30	4.95	11.90	14.90	VDC
	TYP	3.33	5.00	12.00	15.00	
	MAX	3.36	5.05	12.10	15.10	
Rated Load Range	MIN	0.0	0.0	0.0	0.0	A
	MAX	4.0	4.0	1.7	1.4	
Load Regulation 25% Max-Max Load	TYP	1				%
	MAX	1				
Line Regulation Vin = Min-Max VDC	TYP	0.5	0.01			%
	MAX	1.0	0.1			
Short Term Stability (3)	TYP	< 0.05				%/24Hrs
Input Ripple Rejection (4)	TYP	> 40				dB
Noise, 0-20MHz bw (2)	TYP	75				mV _{pp}
RMS Noise, 0.01-1MHz	TYP	15				mV _{rms}
Temperature Coefficient	TYP	50				ppm/°C
	MAX	150				
Short Circuit Protection to Common for all Outputs		Continuous, with Thermal Protection				

NOTES

- (1) All parameters measured at Tc=25°C, nominal input voltage and full rated load unless otherwise noted. Refer to the Technical Reference Section for the definition of terms, measurement circuits and other information.
- (2) Noise is measured per Technical Reference Section. Measurement bandwidth is 0-20 MHz for peak-peak measurements, 10 kHz to 1 MHz for RMS measurements. Output noise is measured with a 0.01µF ceramic in parallel with a 1µF/35V Tantalum capacitor located 1" away from the converter to simulate your PCB's standard decoupling. Input reflected ripple is measured into a 10µH source impedance.
- (3) Short term stability is specified after a 30 minute warmup at full load, constant line and recording the drift over a 24 hour period.
- (4) The input ripple rejection is specified for DC to 120 Hz ripple with a modulation amplitude of 1% of Vin.

DFA20 SERIES — SINGLE OUTPUT

DFA20 SERIES APPLICATION NOTES:

External Capacitance Requirements

No external capacitance is required for operation of the DFA20 Series. The use of input capacitors with less than 0.5Ω ESR may cause peaking in the input filter and degrade filter performance. External output capacitance is not required for operation, however it is recommended that 1μF to 10μF of tantalum and 0.001 to 0.1μF ceramic capacitance be selected for reduced system noise. Additional output capacitance may be added for increased filtering, but should not exceed 400μF.

Negative Outputs

A negative output voltage may be obtained by connecting the +OUT to circuit ground and connecting -OUT as the negative output.

Remote ON/OFF Operation

The remote ON/OFF pin may be left floating if this function is not used. It is recommended to drive this pin with an open collector arrangement or a relay contact. When the ON/OFF pin is pulled low with respect to the -INPUT, the converter is placed in a low power drain state.

Output TRIM

The TRIM pin may be used to adjust the output ±5% from the nominal setting. This function allows adjustment for voltage drops in the system wiring, as well as 5.2 volt outputs for ECL applications. Figure 1 shows the proper connections to use this function. A trimpot value of 10KΩ should be used for 3.3 and 5 volt outputs. A trimpot value of 20KΩ should be used for 12 and 15 volt outputs. If the TRIM function is not required the pin may be left floating.

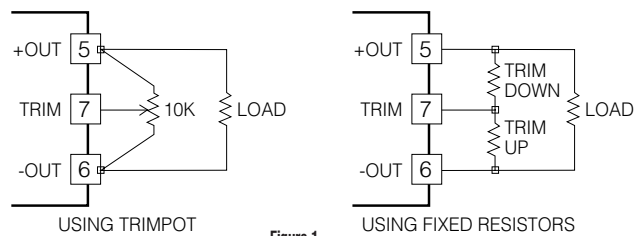
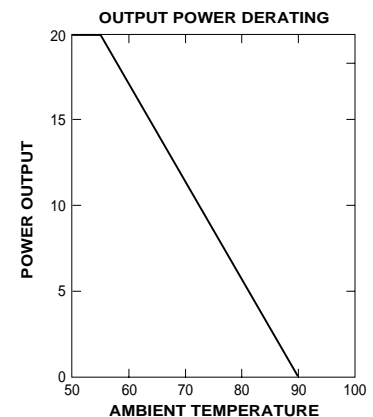
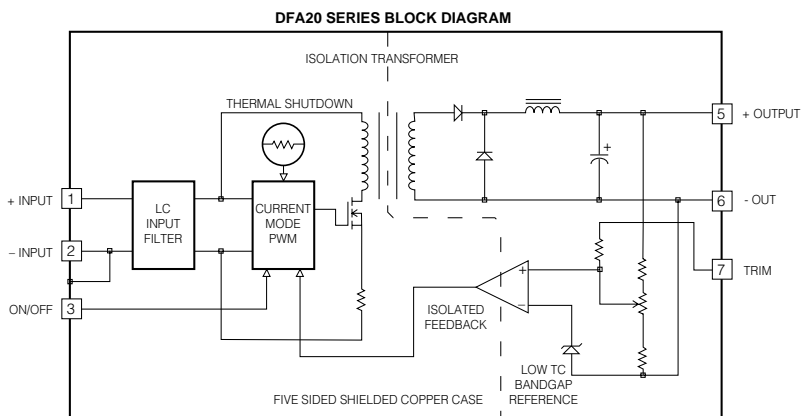

Figure 1.



NUCLEAR AND MEDICAL APPLICATIONS Power-One products are not authorized for use as critical components in life support systems, equipment used in hazardous environments, or nuclear control systems without the express written consent of the President of Power-One, Inc.

TECHNICAL REVISIONS The appearance of products, including safety agency certifications pictured on labels, may change depending on the date manufactured. Specifications are subject to change without notice.

DFA20 SERIES — SINGLE OUTPUT

Typical Performance: (Tc=25°C, Vin=Nom VDC, Rated Load)

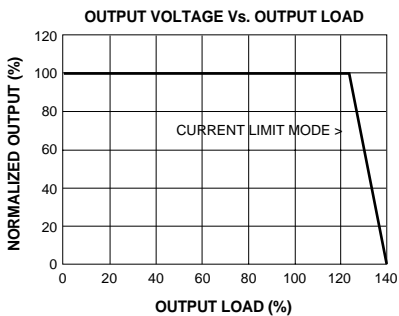
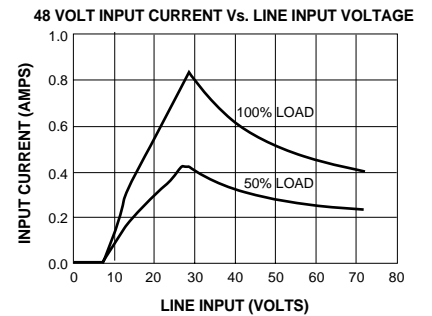
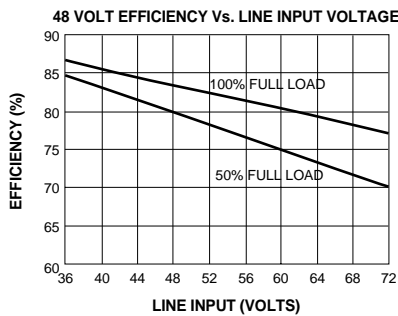
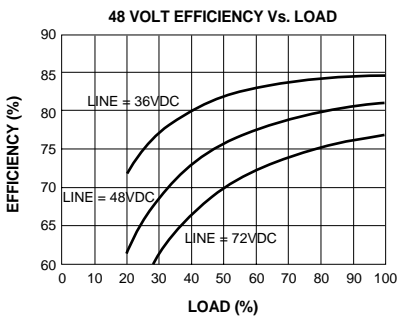
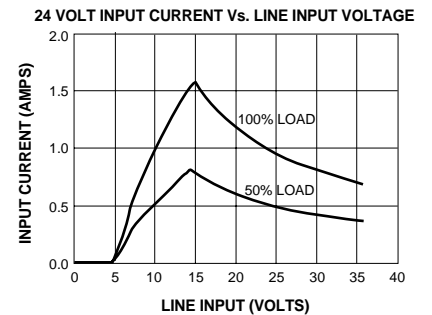
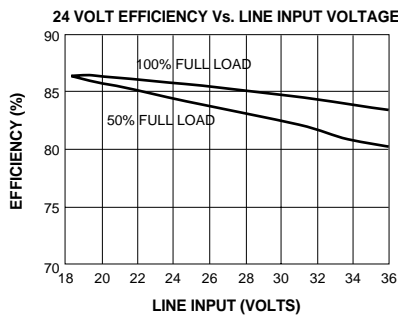
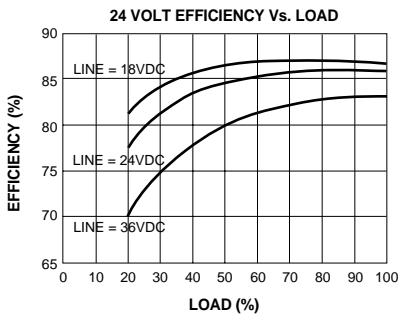
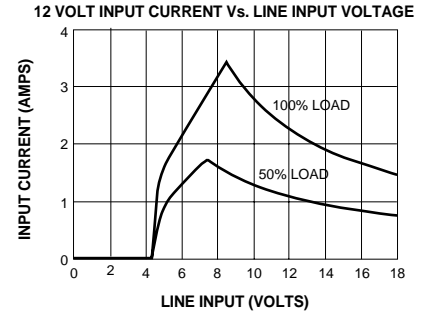
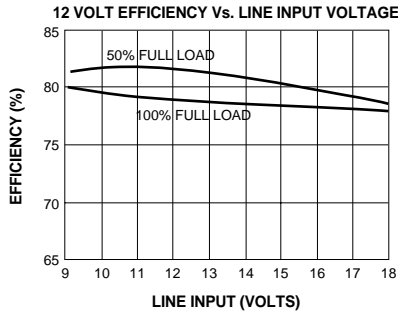
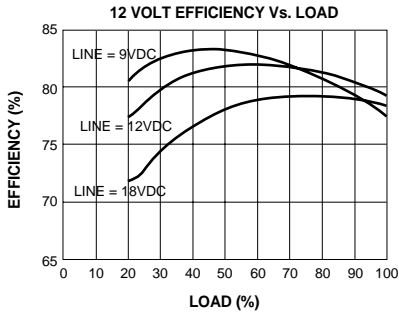

NOTES ON USING THE CURVES

- 1) The input currents are for 20 watts of output power. For ± 5 volt output models the current is approximately 15% less.
- 2) The efficiency curves are for 12 volt output models. To use for other models adjust as follows:
 ± 5 volt models subtract approximately 3%.
 ± 15 volt models add approximately 1%.

For the Most Up-To-Date Information

www.power-one.com

24 Hours/Day—7 Days/Week



LittleDiode supplies new, hard to find or obsolete electronic components and semiconductors all over the world.

With over two million different components listed you are sure to find the part you need.

Feel free to visit us today at our online store:

LittleDiode.com

Looking forward to providing you with the best possible service.