

DM74ALS541

Octal Buffer and Line Driver with 3-STATE Outputs

General Description

This octal buffer and line driver is designed to have the performance of the DM74ALS240A series and, at the same time, offer a pinout with inputs and outputs on opposite sides of the package. This arrangement greatly enhances circuit board layout. The 3-STATE control gate is a 2-input NOR such that if either G1 or G2 is HIGH, all eight outputs are in the high impedance state.

Features

- Advanced oxide-isolated ion-implanted Schottky TTL process
- Switching performance is guaranteed over full temperature and V_{CC} supply range
- Data flow-thru pinout (all inputs on opposite side from outputs)
- P-N-P Inputs reduce DC loading

Ordering Code:

Order Number	Package Number	Package Description
DM74ALS541WM	M20B	20-Lead Small Outline Integrated Circuit (SOIC), JEDEC MS-013, 0.300 Wide
DM74ALS541SJ	M20D	20-Lead Small Outline Package (SOP), EIAJ TYPE II, 5.3mm Wide
DM74ALS541N	N20A	20-Lead Plastic Dual-In-Line Package (PDIP), JEDEC MS-001, 0.300 Wide

Devices also available in Tape and Reel. Specify by appending the suffix letter "X" to the ordering code.

Connection Diagram

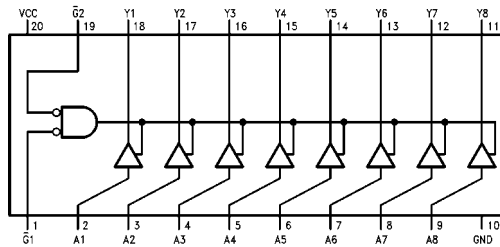

Function Table

Input			Output
$\overline{G1}$	$\overline{G2}$	A	Y
H	X	X	Hi-Z
X	H	X	Hi-Z
L	L	L	L
L	L	H	H

H = HIGH Logic Level
L = LOW Logic Level
X = Don't Care (Either LOW or HIGH Logic Level)
Hi-Z = High Impedance (OFF) State

Absolute Maximum Ratings (Note 1)

Supply Voltage	7V
Input Voltage: Control Inputs	7V
Voltage Applied to a Disabled 3-STATE Output	5.5V
Operating Free-Air Temperature Range	0°C to +70°C
Storage Temperature Range	-65°C to +150°C
Typical θ_{JA}	
N Package	58.5°C/W
M Package	77.5°C/W

Note 1: The "Absolute Maximum Ratings" are those values beyond which the safety of the device cannot be guaranteed. The device should not be operated at these limits. The parametric values defined in the Electrical Characteristics tables are not guaranteed at the absolute maximum ratings. The "Recommended Operating Conditions" table will define the conditions for actual device operation.

Recommended Operating Conditions

Symbol	Parameter	Min	Nom	Max	Units
V_{CC}	Supply Voltage	4.5	5	5.5	V
V_{IH}	HIGH Level Input Voltage	2			V
V_{IL}	LOW Level Input Voltage			0.8	V
I_{OH}	HIGH Level Output Current			-15	mA
I_{OL}	LOW Level Output Current			24	mA
T_A	Free Air Operating Temperature	0		70	°C

Electrical Characteristics

over recommended free air temperature range

Symbol	Parameter	Test Conditions	Min	Typ	Max	Units
V_{IK}	Input Clamp Voltage	$V_{CC} = \text{Min}, I_I = -18 \text{ mA}$			-1.2	V
V_{OH}	HIGH Level Output Voltage	$V_{CC} = 4.5V \text{ to } 5.5V$	$I_{OH} = -0.4 \text{ mA}$	$V_{CC} - 2$		V
		$V_{CC} = \text{Min}$	$I_{OH} = -3 \text{ mA}$	2.4	3.2	
			$I_{OH} = \text{Max}$	2		
V_{OL}	LOW Level Output Voltage	$V_{CC} = \text{Min}$	$I_{OL} = 12 \text{ mA}$	0.25	0.4	mA
			$I_{OL} = 24 \text{ mA}$	0.35	0.5	
I_I	Input Current at Maximum Input Voltage	$V_{CC} = \text{Max}, V_I = 7V$			100	μA
I_{IH}	HIGH Level Input Current	$V_{CC} = \text{Max}, V_I = 2.7V$			20	μA
I_{IL}	LOW Level Input Current	$V_{CC} = \text{Max}, V_I = 0.4V$			-100	μA
I_{OZH}	HIGH Level 3-STATE Output Current	$V_{CC} = \text{Max}, V_O = 2.7V$			20	μA
I_{OZL}	LOW Level 3-STATE Output Current	$V_{CC} = \text{Max}, V_O = 0.4V$			-20	μA
I_O	Output Drive Current	$V_{CC} = \text{Max}, V_O = 2.25V$	-30		-112	mA
I_{CC}	Supply Current	$V_{CC} = \text{Max}$	Outputs HIGH	6	14	mA
			Outputs LOW	15	25	
			Outputs Disabled	13.5	22	

Switching Characteristics

over recommended operating free air temperature range

Symbol	Parameter	Conditions	From (Input) To (Output)	Min	Max	Units
t_{PLH}	Propagation Delay Time LOW-to-HIGH Level Output	$V_{CC} = 4.5V$ to $5.5V$, $R_1 = R_2 = 500\Omega$, $C_L = 50$ pF	A to Y	4	14	ns
t_{PHL}	Propagation Delay Time HIGH-to-LOW Level Output		A to Y	2	10	ns
t_{PZH}	Output Enable Time to HIGH Level Output		\bar{G} to Y	5	15	ns
t_{PZL}	Output Enable Time to LOW Level Output		\bar{G} to Y	8	20	ns
t_{PHZ}	Output Disable Time from HIGH Level Output		\bar{G} to Y	1	10	ns
t_{PLZ}	Output Disable Time from LOW Level Output		\bar{G} to Y	2	12	ns

Physical Dimensions inches (millimeters) unless otherwise noted

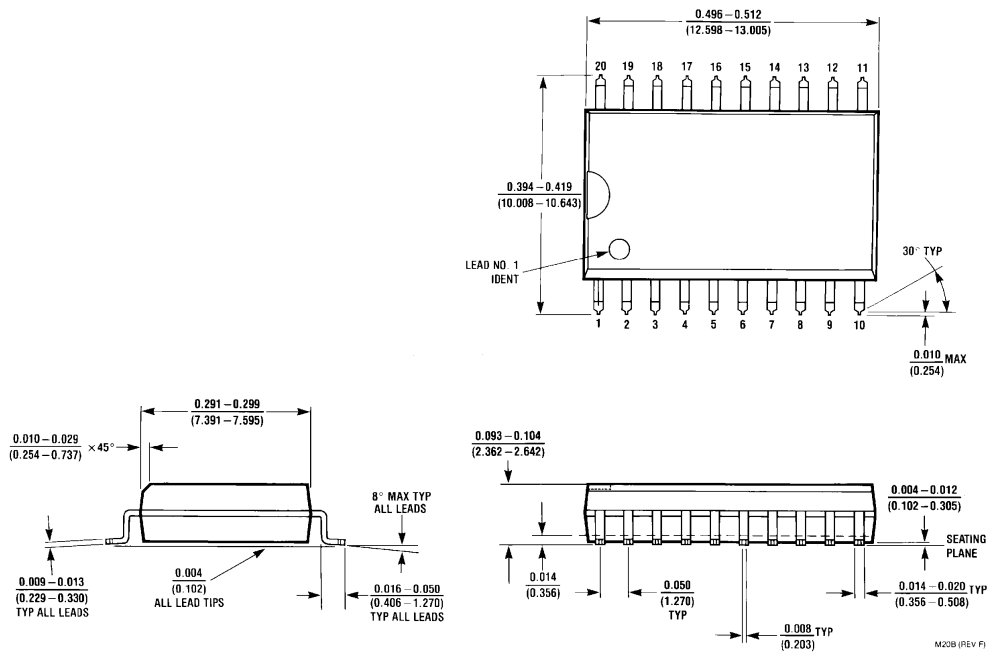

**20-Lead Small Outline Integrated Circuit (SOIC), JEDEC MS-013, 0.300 Wide
Package Number M20B**

Physical Dimensions inches (millimeters) unless otherwise noted (Continued)

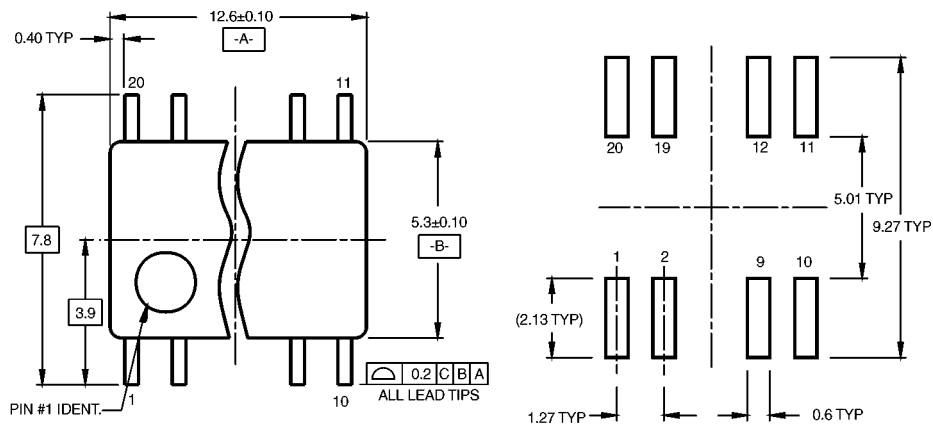

LAND PATTERN RECOMMENDATION

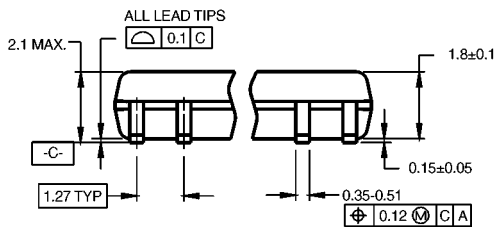

DIMENSIONS ARE IN MILLIMETERS

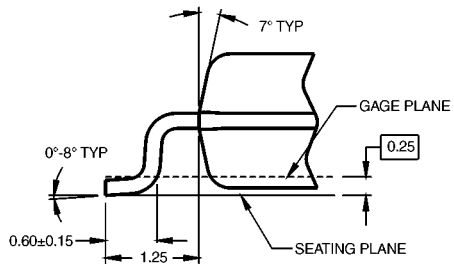
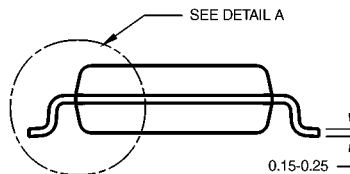

DETAIL A

- NOTES:
- A. CONFORMS TO EIAJ EDR-7320 REGISTRATION, ESTABLISHED IN DECEMBER, 1998.
 - B. DIMENSIONS ARE IN MILLIMETERS.
 - C. DIMENSIONS ARE EXCLUSIVE OF BURRS, MOLD FLASH, AND TIE BAR EXTRUSIONS.

M20DRevB1

**20-Lead Small Outline Package (SOP), EIAJ TYPE II, 5.3mm Wide
Package Number M20D**

Physical Dimensions inches (millimeters) unless otherwise noted (Continued)

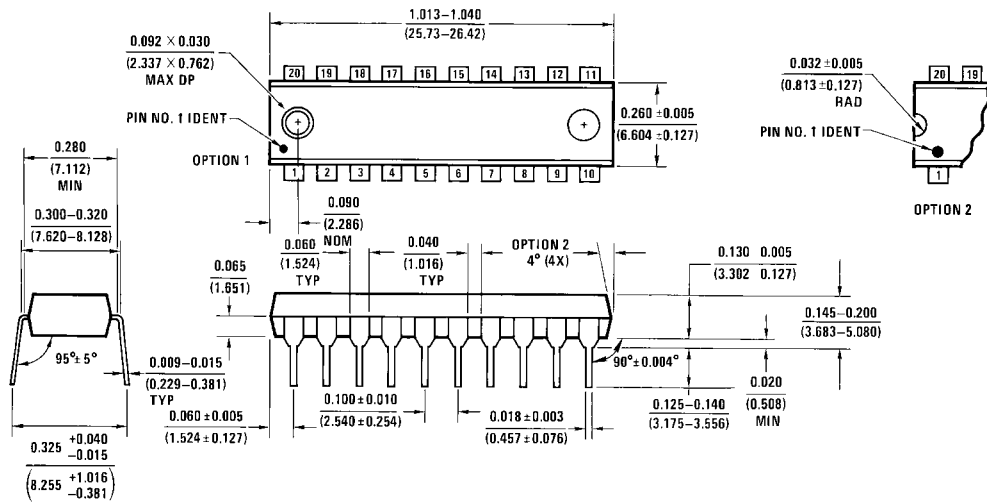

20-Lead Plastic Dual-In-Line Package (PDIP), JEDEC MS-001, 0.300 Wide Package Number N20A

N20A (REV G)

Fairchild does not assume any responsibility for use of any circuitry described, no circuit patent licenses are implied and Fairchild reserves the right at any time without notice to change said circuitry and specifications.

LIFE SUPPORT POLICY

FAIRCHILD'S PRODUCTS ARE NOT AUTHORIZED FOR USE AS CRITICAL COMPONENTS IN LIFE SUPPORT DEVICES OR SYSTEMS WITHOUT THE EXPRESS WRITTEN APPROVAL OF THE PRESIDENT OF FAIRCHILD SEMICONDUCTOR CORPORATION. As used herein:

1. Life support devices or systems are devices or systems which, (a) are intended for surgical implant into the body, or (b) support or sustain life, and (c) whose failure to perform when properly used in accordance with instructions for use provided in the labeling, can be reasonably expected to result in a significant injury to the user.
2. A critical component in any component of a life support device or system whose failure to perform can be reasonably expected to cause the failure of the life support device or system, or to affect its safety or effectiveness.

www.fairchildsemi.com



LittleDiode supplies new, hard to find or obsolete electronic components and semiconductors all over the world.

With over two million different components listed you are sure to find the part you need.

Feel free to visit us today at our online store:

LittleDiode.com

Looking forward to providing you with the best possible service.