

## DS1488 Quad Line Driver

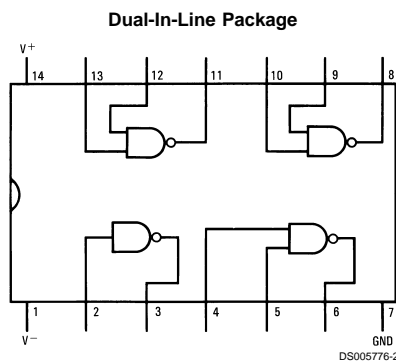
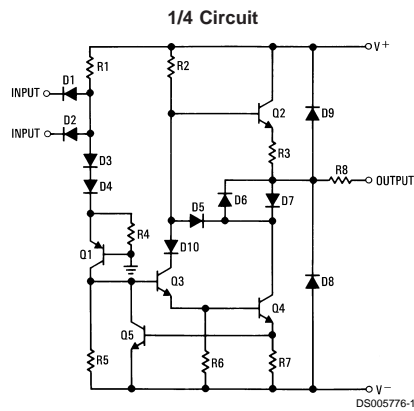
### General Description

The DS1488 is a quad line driver which converts standard TTL input logic levels through one stage of inversion to output levels which meet EIA Standard RS-232D and CCITT Recommendation V.24.

### Features

- Current limited output:  $\pm 10$  mA typ
- Power-off source impedance:  $300\Omega$  min
- Simple slew rate control with external capacitor
- Flexible operating supply range
- Inputs are TTL/LS compatible

### Schematic and Connection Diagrams



**Top View**  
**Order Number DS1488M or DS1488N**  
**See NS Package Number M14A or N14A**

## Absolute Maximum Ratings (Note 2)

If Military/Aerospace specified devices are required, please contact the National Semiconductor Sales Office/Distributors for availability and specifications.

Supply Voltage	
V <sup>+</sup>	+15V
V <sup>-</sup>	-15V
Input Voltage (V <sub>IN</sub> )	-15V ≤ V <sub>IN</sub> ≤ 7.0V
Output Voltage	±15V

Operating Temperature Range	0°C to +75°C
Storage Temperature Range	-65°C to +150°C
Maximum Power Dissipation (Note 1) at 25°C	
Molded DIP Package	1280 mW
SO Package	974 mW
Lead Temperature (Soldering, 4 sec.)	260°C

**Note 1:** Derate molded DIP package 10.2 mW/°C above 25°C; derate SO package 7.8 mW/°C above 25°C.

## Electrical Characteristics (Notes 3, 4)

V<sub>CC+</sub> = 9V, V<sub>CC-</sub> = -9V unless otherwise specified

Symbol	Parameter	Conditions	Min	Typ	Max	Units
I <sub>IL</sub>	Logical "0" Input Current	V <sub>IN</sub> = 0V		-0.8	-1.3	mA
I <sub>IH</sub>	Logical "1" Input Current	V <sub>IN</sub> = +5.0V		0.005	10.0	μA
V <sub>OH</sub>	High Level Output Voltage	R <sub>L</sub> = 3.0 kΩ, V <sup>+</sup> = 9.0V, V <sup>-</sup> = -9.0V	6.0	7.1		V
		V <sub>IN</sub> = 0.8V, V <sup>+</sup> = 13.2V, V <sup>-</sup> = -13.2V	9.0	10.7		V
V <sub>OL</sub>	Low Level Output Voltage	R <sub>L</sub> = 3.0 kΩ, V <sup>+</sup> = 9.0V, V <sup>-</sup> = -9.0V	-6.0	7.0		V
		V <sub>IN</sub> = 1.9V, V <sup>+</sup> = 13.2V, V <sup>-</sup> = -13.2V	-9.0	-10.6		V
I <sub>OS+</sub>	High Level Output Short-Circuit Current	V <sub>OUT</sub> = 0V, V <sub>IN</sub> = 0.8V	-6.0	-10.0	-12.0	mA
I <sub>OS-</sub>	Low Level Output Short-Circuit Current	V <sub>OUT</sub> = 0V, V <sub>IN</sub> = 1.9V	6.0	10.0	12.0	mA
R <sub>OUT</sub>	Output Resistance	V <sup>+</sup> = V <sup>-</sup> = 0V, V <sub>OUT</sub> = ±2V	300			Ω
I <sub>CC+</sub>	Positive Supply Current (Output Open)	V <sub>IN</sub> = 1.9V, V <sup>+</sup> = 9.0V, V <sup>-</sup> = -9.0V		11.6	20.0	mA
		V <sup>+</sup> = 12V, V <sup>-</sup> = -12V		15.7	25.0	mA
		V <sup>+</sup> = 15V, V <sup>-</sup> = -15V		19.4	34.0	mA
		V <sub>IN</sub> = 0.8V, V <sup>+</sup> = 9.0V, V <sup>-</sup> = -9.0V		3.4	6.0	mA
		V <sup>+</sup> = 12V, V <sup>-</sup> = -12V		4.1	7.0	mA
		V <sup>+</sup> = 15V, V <sup>-</sup> = -15V		9.1	12.0	mA
I <sub>CC-</sub>	Negative Supply Current (Output Open)	V <sub>IN</sub> = 1.9V, V <sup>+</sup> = 9.0V, V <sup>-</sup> = -9.0V		-10.8	-17.0	mA
		V <sup>+</sup> = 12V, V <sup>-</sup> = -12V		-14.6	-23.0	mA
		V <sup>+</sup> = 15V, V <sup>-</sup> = -15V		-18.3	-34.0	mA
		V <sub>IN</sub> = 0.8V, V <sup>+</sup> = 9.0V, V <sup>-</sup> = -9.0V		-0.001	-0.100	mA
		V <sup>+</sup> = 12V, V <sup>-</sup> = -12V		-0.001	-0.100	mA
		V <sup>+</sup> = 15V, V <sup>-</sup> = -15V		-0.01	-2.5	mA
P <sub>d</sub>	Power Dissipation	V <sup>+</sup> = 9.0V, V <sup>-</sup> = -9.0V		252	333	mW
		V <sup>+</sup> = 12V, V <sup>-</sup> = -12V		444	576	mW

## Switching Characteristics

(V<sub>CC</sub> = 9V, V<sub>EE</sub> = -9V, T<sub>A</sub> = 25°C)

Symbol	Parameter	Conditions	Min	Typ	Max	Units
t <sub>pd1</sub>	Propagation Delay to a Logical "1"	R <sub>L</sub> = 3.0 kΩ, C <sub>L</sub> = 15 pF, T <sub>A</sub> = 25°C		187	350	ns
t <sub>pd0</sub>	Propagation Delay to a Logical "0"	R <sub>L</sub> = 3.0 kΩ, C <sub>L</sub> = 15 pF, T <sub>A</sub> = 25°C		45	175	ns
t <sub>r</sub>	Rise Time	R <sub>L</sub> = 3.0 kΩ, C <sub>L</sub> = 15 pF, T <sub>A</sub> = 25°C		63	100	ns
t <sub>f</sub>	Fall Time	R <sub>L</sub> = 3.0 kΩ, C <sub>L</sub> = 15 pF, T <sub>A</sub> = 25°C		33	75	ns

**Note 2:** "Absolute Maximum Ratings" are those values beyond which the safety of the device cannot be guaranteed. Except for "Operating Temperature Range" they are not meant to imply that the devices should be operated at these limits. The table of "Electrical Characteristics" provides conditions for actual device operation.

**Note 3:** Unless otherwise specified min/max limits apply across the 0°C to +75°C temperature range for the DS1488.

**Note 4:** All currents into device pins shown as positive, out of device pins as negative, all voltages referenced to ground unless otherwise noted. All values shown as max or min on absolute value basis.

## Applications

By connecting a capacitor to each driver output the slew rate can be controlled utilizing the output current limiting characteristics of the DS1488. For a set slew rate the appropriate capacitor value may be calculated using the following relationship

$$C = I_{SC} (\Delta T / \Delta V)$$

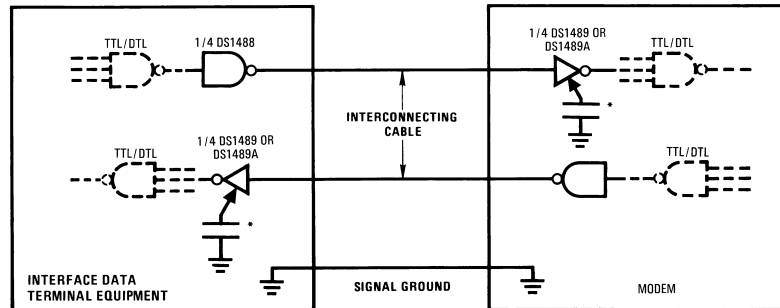
where C is the required capacitor,  $I_{SC}$  is the short circuit current value, and  $\Delta V / \Delta T$  is the slew rate.

RS-232C specifies that the output slew rate must not exceed 30V per microsecond. Using the worst case output short circuit current of 12 mA in the above equation, calculations result in a required capacitor of 400 pF connected to each output.

See Typical Performance Characteristics.

## Typical Applications

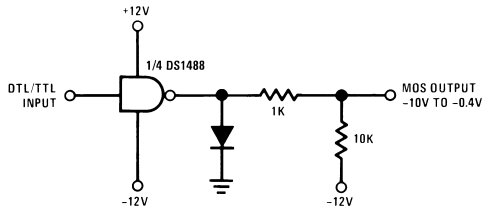
RS-232C Data Transmission



DS005776-3

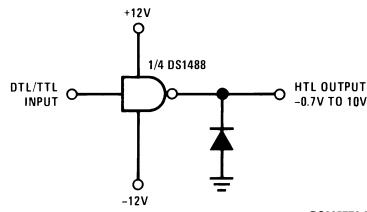
Note 5: Optional for noise filtering

DTL/TTL-to-MOS Translator



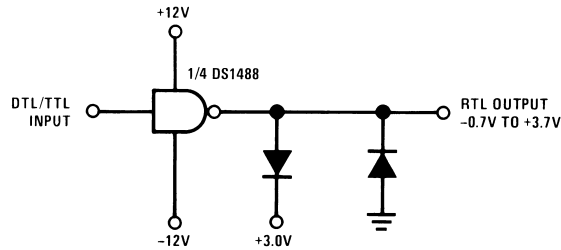
DS005776-4

DTL/TTL-to-HTL Translator



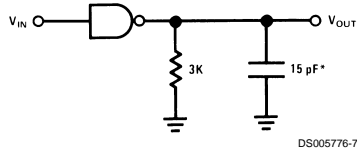
DS005776-5

DTL/TTL-to-RTL Translator

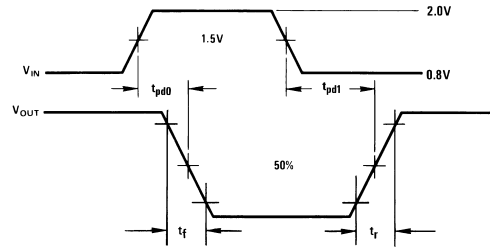


DS005776-6

## AC Load Circuit and Switching Time Waveforms

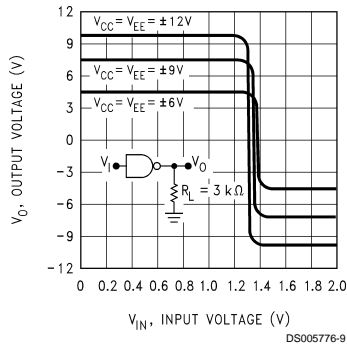


\* $C_L$  includes probe and jig capacitance.

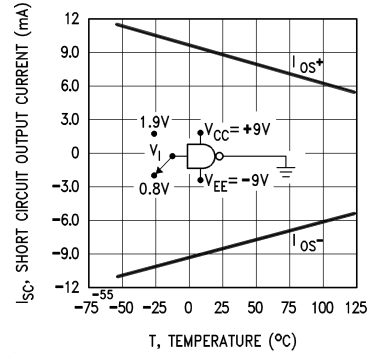


$t_r$  and  $t_f$  are measured between 10% and 90% of the output waveform.

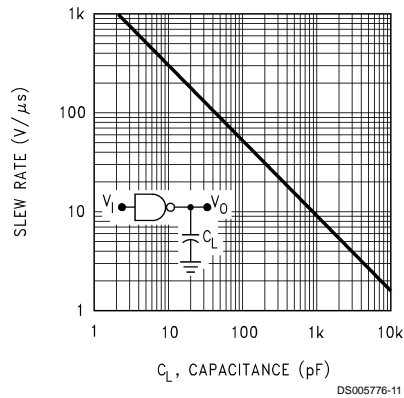
## Typical Performance Characteristics $T_A = +25^\circ\text{C}$ unless otherwise noted



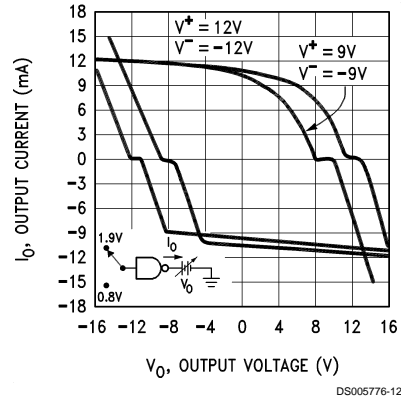
**FIGURE 1. Transfer Characteristics vs Power Supply Voltage**



**FIGURE 2. Short-Circuit Output Current vs Temperature**

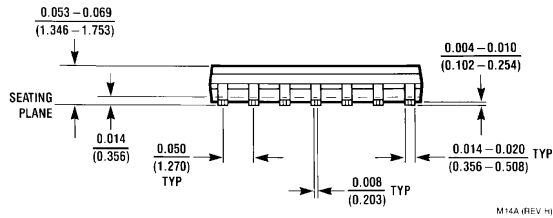
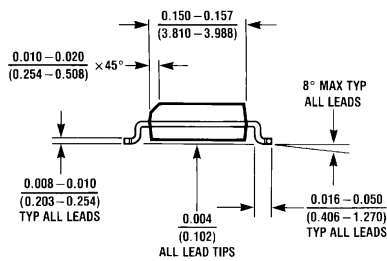
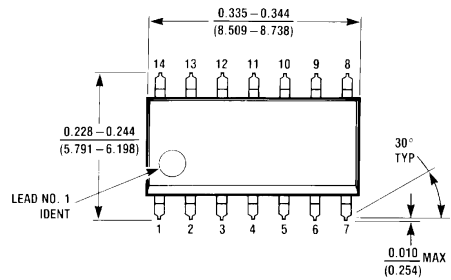


**FIGURE 3. Output Slew Rate vs Load Capacitance**



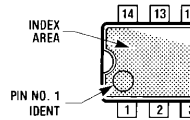
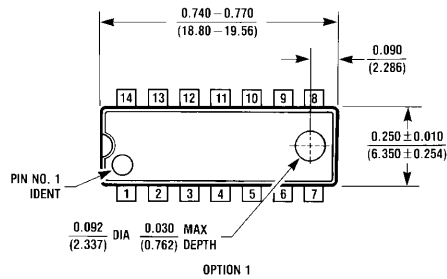
**FIGURE 4. Output Voltage and Current-Limiting Characteristics**

**Physical Dimensions** inches (millimeters) unless otherwise noted

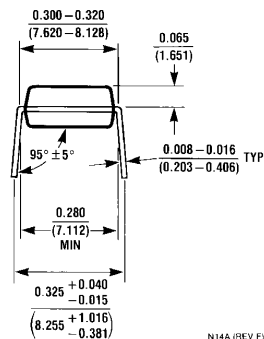
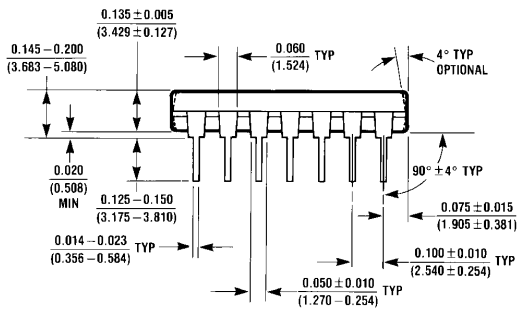


M14A (REV H)

**SO Package (M)**  
**Order Number DS1488M**  
**NS Package Number M14A**



OPTION 02



N14A (REV F)

**Molded Dual-In-Line Package (N)**  
**Order Number DS1488N**  
**NS Package Number N14A**

## Notes

### LIFE SUPPORT POLICY

NATIONAL'S PRODUCTS ARE NOT AUTHORIZED FOR USE AS CRITICAL COMPONENTS IN LIFE SUPPORT DEVICES OR SYSTEMS WITHOUT THE EXPRESS WRITTEN APPROVAL OF THE PRESIDENT AND GENERAL COUNSEL OF NATIONAL SEMICONDUCTOR CORPORATION. As used herein:

1. Life support devices or systems are devices or systems which, (a) are intended for surgical implant into the body, or (b) support or sustain life, and whose failure to perform when properly used in accordance with instructions for use provided in the labeling, can be reasonably expected to result in a significant injury to the user.
2. A critical component is any component of a life support device or system whose failure to perform can be reasonably expected to cause the failure of the life support device or system, or to affect its safety or effectiveness.



**National Semiconductor Corporation**  
Americas  
Tel: 1-800-272-9959  
Fax: 1-800-737-7018  
Email: support@nsc.com

[www.national.com](http://www.national.com)

**National Semiconductor Europe**  
Fax: +49 (0) 1 80-530 85 86  
Email: europe.support@nsc.com  
Deutsch Tel: +49 (0) 1 80-530 85 85  
English Tel: +49 (0) 1 80-532 78 32  
Français Tel: +49 (0) 1 80-532 93 58  
Italiano Tel: +49 (0) 1 80-534 16 80

**National Semiconductor Asia Pacific Customer Response Group**  
Tel: 65-2544466  
Fax: 65-2504466  
Email: sea.support@nsc.com

**National Semiconductor Japan Ltd.**  
Tel: 81-3-5639-7560  
Fax: 81-3-5639-7507

# National Semiconductor was acquired by Texas Instruments.

[http://www.ti.com/corp/docs/investor\\_relations/pr\\_09\\_23\\_2011\\_national\\_semiconductor.html](http://www.ti.com/corp/docs/investor_relations/pr_09_23_2011_national_semiconductor.html)

This file is the datasheet for the following electronic components:

DS1488MX - <http://www.ti.com/product/ds1488mx?HQS=TI-null-null-dscatalog-df-pf-null-wwe>

DS1488N - <http://www.ti.com/product/ds1488n?HQS=TI-null-null-dscatalog-df-pf-null-wwe>

DS1488M - <http://www.ti.com/product/ds1488m?HQS=TI-null-null-dscatalog-df-pf-null-wwe>



LittleDiode supplies new, hard to find or obsolete electronic components and semiconductors all over the world.

With over two million different components listed you are sure to find the part you need.

Feel free to visit us today at our online store:

[LittleDiode.com](http://LittleDiode.com)

Looking forward to providing you with the best possible service.