

DS75365 Quad TTL-to-MOS Driver

General Description

The DS75365 is a quad monolithic integrated TTL-to-MOS driver and interface circuit that accepts standard TTL input signals and provides high-current and high-voltage output levels suitable for driving MOS circuits. It is used to drive address, control, and timing inputs for several types of MOS RAMs including the 1103.

The DS75365 operates from the TTL 5V supply and the MOS V_{SS} and V_{BB} supplies in many applications. This device has been optimized for operation with V_{CC2} supply voltage from 16V to 20V, and with nominal V_{CC3} supply voltage from 3V to 4V higher than V_{CC2} . However, it is designed so as to be usable over a much wider range of V_{CC2} and V_{CC3} . In some applications the V_{CC3} power supply can be eliminated by connecting the V_{CC3} to the V_{CC2} pin.

Features

- Quad positive-logic NAND TTL-to-MOS driver
- Versatile interface circuit for use between TTL and high-current, high-voltage systems

- Capable of driving high-capacitance loads
- Compatible with many popular MOS RAMs
- Interchangeable with Intel 3207
- V_{CC2} supply voltage variable over wide range to 24V maximum
- V_{CC3} supply voltage pin available
- V_{CC3} pin can be connected to V_{CC2} pin in some applications
- TTL compatible diode-clamped inputs
- Operates from standard bipolar and MOS supply voltages
- Two common enable inputs per gate-pair
- High-speed switching
- Transient overdrive minimizes power dissipation
- Low standby power dissipation

Schematic and Connection Diagrams

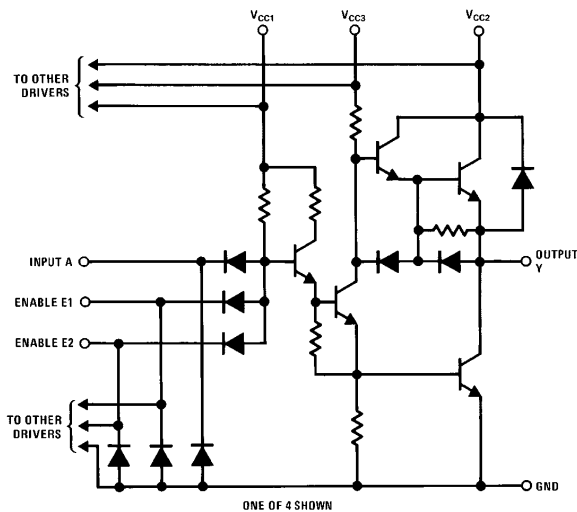

TL/F/7560-1

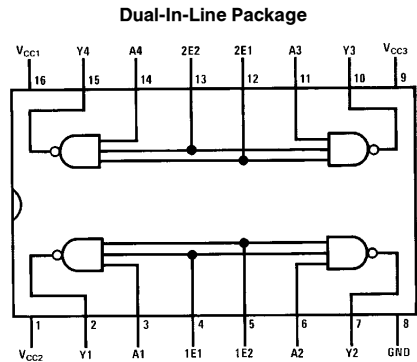

TL/F/7560-2

Top View
Positive Logic: $Y = \bar{A} \cdot E1 \cdot E2$

Order Number DS75365N or DS75365WM
See NS Package Number M16B or N16A

Absolute Maximum Ratings (Note 1)

If Military/Aerospace specified devices are required, please contact the National Semiconductor Sales Office/Distributors for availability and specifications.

Supply Voltage Range of V _{CC1}	-0.5V to 7V
Supply Voltage Range of V _{CC2}	-0.5V to 25V
Supply Voltage Range of V _{CC3}	-0.5V to 30V
Input Voltage	5.5V
Inter-Input Voltage (Note 4)	5.5V
Storage Temperature Range	-65°C to +150°C
Maximum Power Dissipation* at 25°C	
Cavity Package	1509 mW
Molded Package	1476 mW
SO Package	1488 mW
Lead Temperature (Soldering, 10 sec)	300°C

* Derate cavity package 10.1 mW/°C above 25°C; derate molded package 11.8 mW/°C above 25°C, derate SO package 11.9 mW/°C above 25°C.

Operating Conditions

	Min	Max	Units
Supply Voltage (V _{CC1})	4.75	5.25	V
Supply Voltage (V _{CC2})	4.75	24	V
Supply Voltage (V _{CC3})	V _{CC2}	28	V
Voltage Difference Between Supply Voltages: V _{CC3} -V _{CC2}	0	10	V
Operating Ambient Temperature Range (T _A)	0	70	°C

Electrical Characteristics (Notes 2 and 3)

Symbol	Parameter	Conditions	Min	Typ	Max	Units	
V _{IH}	High-Level Input Voltage		2			V	
V _{IL}	Low-Level Input Voltage				0.8	V	
V _I	Input Clamp Voltage	I _I = -12 mA			-1.5	V	
V _{OH}	High-Level Output Voltage	V _{CC3} = V _{CC2} + 3V, V _{IL} = 0.8V, I _{OH} = -100 μA	V _{CC2} - 0.3	V _{CC2} - 0.1		V	
		V _{CC3} = V _{CC2} + 3V, V _{IL} = 0.8V, I _{OH} = -10 mA	V _{CC2} - 1.2	V _{CC2} - 0.9		V	
		V _{CC3} = V _{CC2} , V _{IL} = 0.8V, I _{OH} = -50 μA	V _{CC2} - 1	V _{CC2} - 0.7		V	
		V _{CC3} = V _{CC2} , V _{IL} = 0.8V, I _{OH} = -10 mA	V _{CC2} - 2.3	V _{CC2} - 1.8		V	
V _{OL}	Low-Level Output Voltage	V _{IH} = 2V, I _{OL} = 10 mA		0.15	0.3	V	
		V _{CC3} = 15V to 28V, V _{IH} = 2V, I _{OL} = 40 mA		0.25	0.5	V	
V _O	Output Clamp Voltage	V _I = 0V, I _{OH} = 20 mA			V _{CC2} + 1.5	V	
I _I	Input Current at Maximum Input Voltage	V _I = 5.5V			1	mA	
I _{IH}	High-Level Input Current	V _I = 2.4V	A Inputs		40	μA	
			E1 and E2 Inputs		80	μA	
I _{IL}	Low-Level Input Current	V _I = 0.4V	A Inputs		-1	-1.6	mA
			E1 and E2 Inputs		-2	-3.2	mA
I _{CC1(H)}	Supply Current from V _{CC1} , All Outputs High	V _{CC1} = 5.25V, V _{CC2} = 24V V _{CC3} = 28V, All Inputs at 0V, No Load		4	8	mA	
I _{CC2(H)}	Supply Current from V _{CC2} , All Outputs High			-2.2	+0.25	mA	
				-2.2	-3.2	mA	
I _{CC3(H)}	Supply Current from V _{CC3} , All Outputs High			2.2	3.5	mA	
I _{CC1(L)}	Supply Current from V _{CC1} , All Outputs Low	V _{CC1} = 5.25V, V _{CC2} = 24V V _{CC3} = 28V, All Inputs at 5V, No Load		31	47	mA	
I _{CC2(L)}	Supply Current from V _{CC2} , All Outputs Low				3	mA	
I _{CC3(L)}	Supply Current from V _{CC3} , All Outputs Low		16	25	mA		
I _{CC2(H)}	Supply Current from V _{CC2} , All Outputs High	V _{CC1} = 5.25V, V _{CC2} = 24V V _{CC3} = 24V, All Inputs at 0V, No Load			0.25	mA	
I _{CC3(H)}	Supply Current from V _{CC3} , All Outputs High				0.5	mA	

Electrical Characteristics (Notes 2, 3) (Continued)

Symbol	Parameter	Conditions	Min	Typ	Max	Units
$I_{CC2(S)}$	Supply Current from V_{CC2} , Stand-By Condition	$V_{CC1} = 0V, V_{CC2} = 24V$ $V_{CC3} = 24V$, All Inputs at 5V, No Load			0.25	mA
$I_{CC3(S)}$	Supply Current from V_{CC3} , Stand-By Condition				0.5	mA

Note 1: "Absolute Maximum Ratings" are those values beyond which the safety of the device cannot be guaranteed. Except for "Operating Temperature Range" they are not meant to imply that the devices should be operated at these limits. The table of "Electrical Characteristics" provides conditions for actual device operation.

Note 2: Unless otherwise specified, min/max limits apply across the 0°C to +70°C range for the DS75365. All typical values are for $T_A = 25^\circ\text{C}$ and $V_{CC1} = 5V$ and $V_{CC2} = 20V$ and $V_{CC3} = 24V$.

Note 3: All currents into device pins shown as positive, out of device pins as negative, all voltages referenced to ground unless otherwise noted. All values shown as max or min on absolute value basis.

Note 4: This rating applies between any two inputs of any one of the gates.

Switching Characteristics $V_{CC1} = 5V, V_{CC2} = 20V, V_{CC3} = 24V, T_A = 25^\circ\text{C}$

Symbol	Parameter	Conditions	Min	Typ	Max	Units	
t_{DLH}	Delay Time, Low-to-High Level Output	$C_L = 200\text{ pF}$ $R_D = 24\Omega$ (Figure 1)		11	20	ns	
t_{DHL}	Delay Time, High-to-Low Level Output			10	18	ns	
t_{TLH}	Transition Time, Low-to-High Level Output			20	33	ns	
t_{THL}	Transition Time, High-to-Low Level Output			20	33	ns	
t_{PLH}	Propagation Delay Time, Low-to-High Level Output			10	31	48	ns
t_{PHL}	Propagation Delay Time, High-to-Low Level Output			10	30	46	ns

AC Test Circuit and Switching Time Waveforms

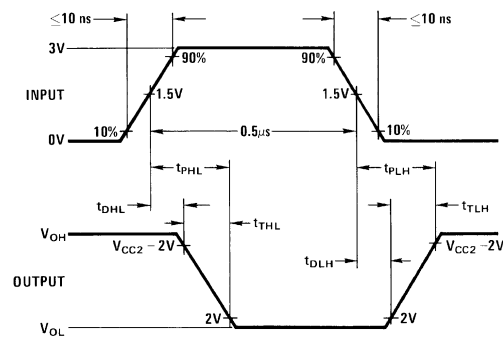
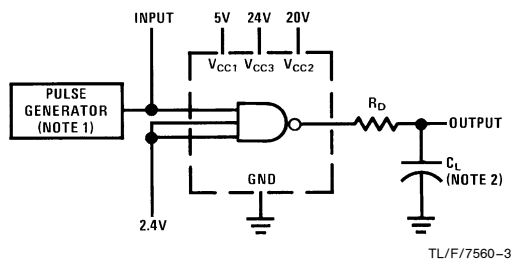

Note 1: The pulse generator has the following characteristics: PRR = 1 MHz, $Z_{OUT} = 58\Omega$.

Note 2: C_L includes probe and jig capacitance.

FIGURE 1. Switching Times, Each Driver

Typical Performance Characteristics

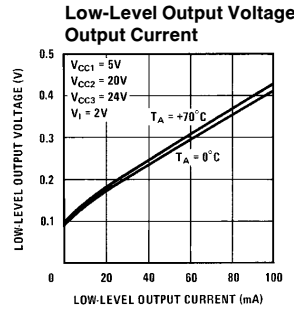
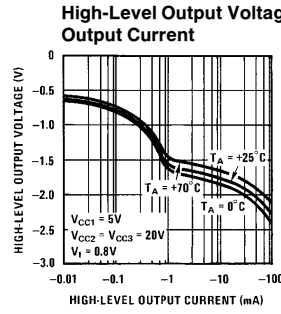
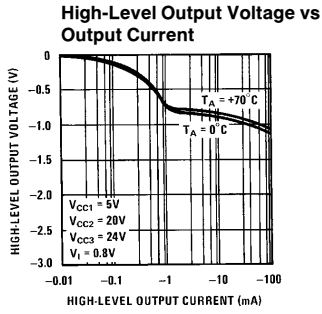

TL/F/7560-5

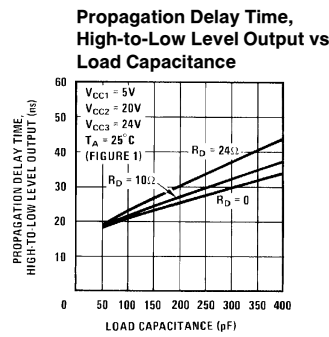
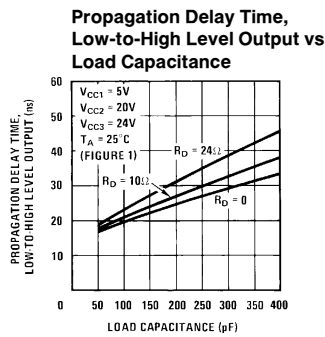
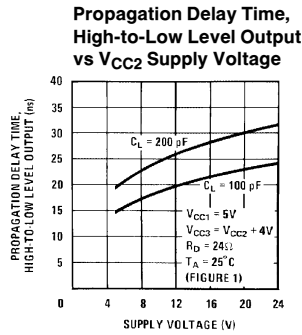
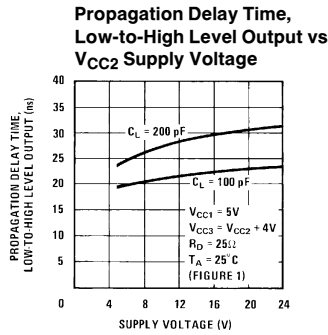
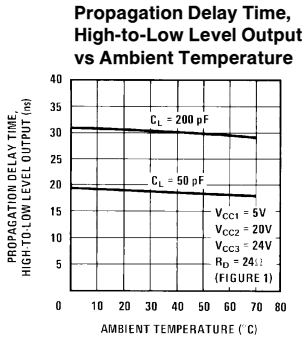
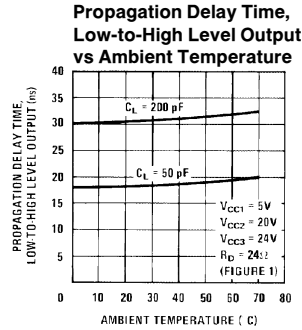
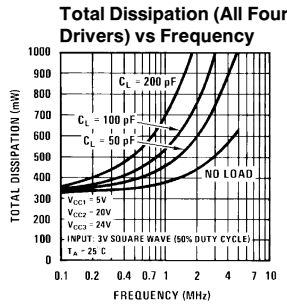
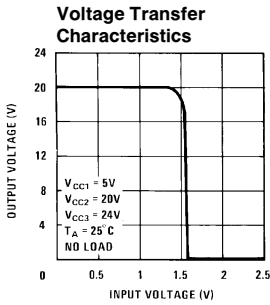

TL/F/7560-6

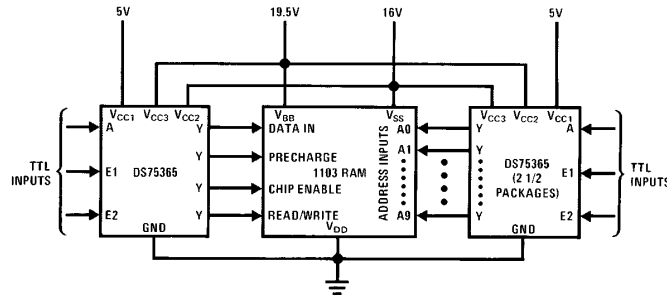
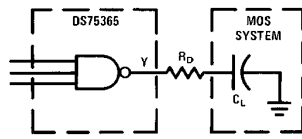

FIGURE 2. Interconnection of DS75365 Devices with 1103-Type Silicon-Gate MOS RAM

TL/F/7560-7

Typical Applications

The fast switching speeds of this device may produce undesirable output transient overshoot because of load or wiring inductance. A small series damping resistor may be used to reduce or eliminate this output transient overshoot. The optimum value of the damping resistor depends on the specific load characteristics and switching speed. A typical value would be between 10Ω and 30Ω (Figure 3).



Note: $R_D \approx 10\Omega$ to 30Ω (Optional)

TL/F/7560-8

FIGURE 3. Use of Damping Resistor to Reduce or Eliminate Output Transient Overshoot in Certain DS75365 Applications

Thermal Information

POWER DISSIPATION PRECAUTIONS

Significant power may be dissipated in the DS75365 driver when charging and discharging high-capacitance loads over a wide voltage range at high frequencies. The total dissipation curve shows the power dissipated in a typical DS75365 as a function of load capacitance and frequency. Average power dissipation by this driver can be broken into three components:

$$P_{T(AV)} = P_{DC(AV)} + P_{C(AV)} + P_{S(AV)}$$

where $P_{DC(AV)}$ is the steady-state power dissipation with the output high or low, $P_{C(AV)}$ is the power level during charging or discharging of the load capacitance, and $P_{S(AV)}$ is the power dissipation during switching between the low and high levels. None of these include energy transferred to the load and all are averaged over a full cycle.

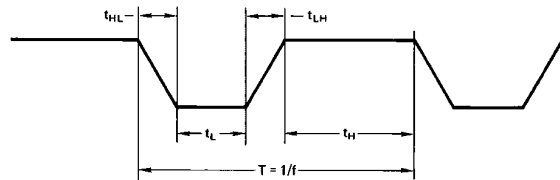

FIGURE 4. Output Voltage Waveform

TL/F/7560-9

The power components per driver channel are:

$$P_{DC(AV)} = \frac{P_{LH}t_L + P_{HL}t_H}{T}$$

$$P_{C(AV)} \approx C V_C^2 f$$

$$P_{S(AV)} = \frac{P_{LH}t_{rH} + P_{HL}t_{rL}}{T}$$

where the times are as defined in Figure 4.

P_L , P_H , P_{LH} , and P_{HL} are the respective instantaneous levels of power dissipation and C is load capacitance.

The DS75365 is so designed that P_S is a negligible portion of P_T in most applications. Except at very high frequencies, $t_L + t_H \gg t_{rH} + t_{rL}$ so that P_S can be neglected. The total dissipation curve for no load demonstrates this point. The power dissipation contributions from all four channels are then added together to obtain total device power.

The following example illustrates this power calculation technique. Assume all four channels are operating identically with $C = 100$ pF, $f = 2$ MHz, $V_{CC1} = 5V$, $V_{CC2} = 20V$, $V_{CC3} = 24V$ and duty cycle = 60% outputs high ($t_H/T = 0.6$). Also, assume $V_{OH} = 20V$, $V_{OL} = 0.1V$, P_S is negligible, and that the current from V_{CC2} is negligible when the output is low.

On a per-channel basis using data sheet values:

$$P_{DC(AV)} = \left[(5V) \left(\frac{4 \text{ mA}}{4} \right) + (20V) \left(\frac{-2.2 \text{ mA}}{4} \right) + (24V) \left(\frac{2.2 \text{ mA}}{4} \right) \right] (0.6) + \left[(5V) \left(\frac{31 \text{ mA}}{4} \right) + (20V) \left(\frac{0 \text{ mA}}{4} \right) + (24V) \left(\frac{16 \text{ mA}}{4} \right) \right] (0.4)$$

$$P_{DC(AV)} = 58 \text{ mW per channel}$$

$$P_{C(AV)} \approx (100 \text{ pF}) (19.9V)^2 (2 \text{ MHz})$$

$$P_{C(AV)} \approx 79 \text{ mW per channel.}$$

For the total device dissipation of the four channels:

$$P_{T(AV)} \approx 4 (58 + 79)$$

$$P_{T(AV)} \approx 548 \text{ mW typical for total package.}$$

Physical Dimensions inches (millimeter)

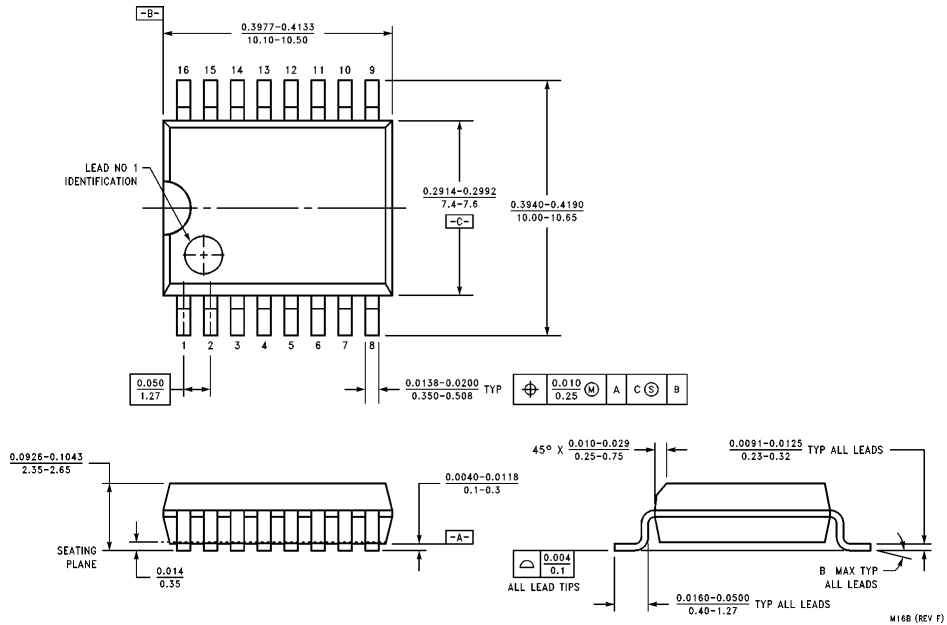

Molded Dual-In-Line Package (M)
Order Number DS75365WM
NS Package Number M16B

M16B (REV F)

Physical Dimensions inches (millimeter) (Continued)

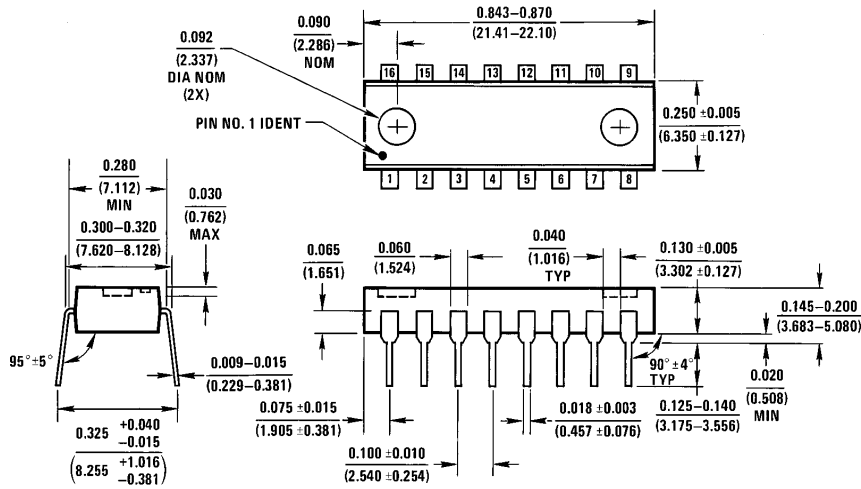

Molded Dual-In-Line Package (N)
Order Number DS75365N
NS Package Number N16A

N16A (REV E)

LIFE SUPPORT POLICY

NATIONAL'S PRODUCTS ARE NOT AUTHORIZED FOR USE AS CRITICAL COMPONENTS IN LIFE SUPPORT DEVICES OR SYSTEMS WITHOUT THE EXPRESS WRITTEN APPROVAL OF THE PRESIDENT OF NATIONAL SEMICONDUCTOR CORPORATION. As used herein:

1. Life support devices or systems are devices or systems which, (a) are intended for surgical implant into the body, or (b) support or sustain life, and whose failure to perform, when properly used in accordance with instructions for use provided in the labeling, can be reasonably expected to result in a significant injury to the user.
2. A critical component is any component of a life support device or system whose failure to perform can be reasonably expected to cause the failure of the life support device or system, or to affect its safety or effectiveness.



National Semiconductor Corporation
 1111 West Bardin Road
 Arlington, TX 76017
 Tel: 1(800) 272-9959
 Fax: 1(800) 737-7018

National Semiconductor Europe
 Fax: (+49) 0-180-530 85 86
 Email: cnjwge@tevm2.nsc.com
 Deutsch Tel: (+49) 0-180-530 85 85
 English Tel: (+49) 0-180-532 78 32
 Français Tel: (+49) 0-180-532 93 58
 Italiano Tel: (+49) 0-180-534 16 80

National Semiconductor Hong Kong Ltd.
 19th Floor, Straight Block,
 Ocean Centre, 5 Canton Rd.
 Tsimshatsui, Kowloon
 Hong Kong
 Tel: (852) 2737-1600
 Fax: (852) 2736-9960

National Semiconductor Japan Ltd.
 Tel: 81-043-299-2309
 Fax: 81-043-299-2408

National does not assume any responsibility for use of any circuitry described, no circuit patent licenses are implied and National reserves the right at any time without notice to change said circuitry and specifications.

This datasheet has been downloaded from:

www.DatasheetCatalog.com

Datasheets for electronic components.

National Semiconductor was acquired by Texas Instruments.

http://www.ti.com/corp/docs/investor_relations/pr_09_23_2011_national_semiconductor.html

This file is the datasheet for the following electronic components:

DS75365WM - <http://www.ti.com/product/ds75365wm?HQS=TI-null-null-dscatalog-df-pf-null-ww>

DS75365N - <http://www.ti.com/product/ds75365n?HQS=TI-null-null-dscatalog-df-pf-null-ww>



LittleDiode supplies new, hard to find or obsolete electronic components and semiconductors all over the world.

With over two million different components listed you are sure to find the part you need.

Feel free to visit us today at our online store:

LittleDiode.com

Looking forward to providing you with the best possible service.