

## DS90C032

# LVDS Quad CMOS Differential Line Receiver

### General Description

The DS90C032 is a quad CMOS differential line receiver designed for applications requiring ultra low power dissipation and high data rates. The device is designed to support data rates in excess of 155.5 Mbps (77.7 MHz) utilizing Low Voltage Differential Signaling (LVDS) technology.

The DS90C032 accepts low voltage (350 mV) differential input signals and translates them to CMOS (TTL compatible) output levels. The receiver supports a TRI-STATE® function that may be used to multiplex outputs. The receiver also supports OPEN, shorted and terminated (100Ω) input Fail-safe with the addition of external failsafe biasing. Receiver output will be HIGH for both Failsafe conditions.

The DS90C032 and companion line driver (DS90C031) provide a new alternative to high power pseudo-ECL devices for high speed point-to-point interface applications.

### Features

- >155.5 Mbps (77.7 MHz) switching rates
- Accepts small swing (350 mV) differential signal levels
- Ultra low power dissipation
- 600 ps maximum differential skew (5V, 25°C)
- 6.0 ns maximum propagation delay
- Industrial operating temperature range
- Military operating temperature range option
- Available in surface mount packaging (SOIC) and (LCC)
- Pin compatible with DS26C32A, MB570 (PECL) and 41LF (PECL)
- Supports OPEN, short and terminated input fail-safe
- Compatible with IEEE 1596.3 SCI LVDS standard
- Conforms to ANSI/TIA/EIA-644 LVDS standard
- Available to Standard Microcircuit Drawing (SMD) 5962-95834

### Connection Diagrams

Dual-In-Line

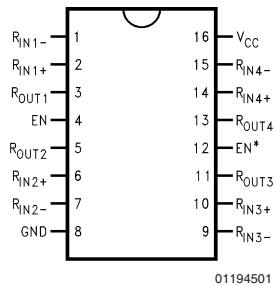

Order Number  
**DS90C032TM**  
 See NS Package Number M16A

LCC Package

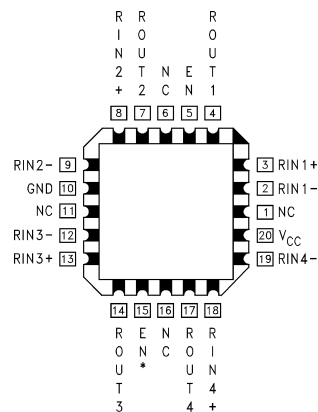

Order Number  
**DS90C032E-QML**  
 See NS Package Number E20A  
 For complete Military Specifications,  
 refer to appropriate SMD or MDS.

## Functional Diagram and Truth Tables

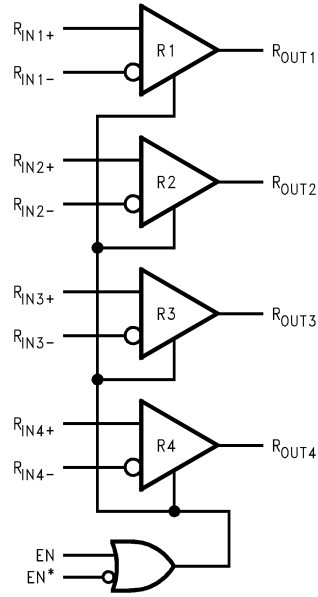

01194502

### Receiver

ENABLES		INPUTS	OUTPUT
EN	EN*	R <sub>IN+</sub> - R <sub>IN-</sub>	R <sub>OUT</sub>
L	H	X	Z
All other combinations of ENABLE inputs		$V_{ID} \geq 0.1V$	H
		$V_{ID} \leq -0.1V$	L
		Full Fail-safe OPEN/SHORT or Terminated	H

**Absolute Maximum Ratings** (Note 1)

If Military/Aerospace specified devices are required, please contact the National Semiconductor Sales Office/Distributors for availability and specifications.

Supply Voltage ( $V_{CC}$ )	-0.3V to +6V
Input Voltage ( $R_{IN+}$ , $R_{IN-}$ )	-0.3V to ( $V_{CC} + 0.3V$ )
Enable Input Voltage (EN, EN*)	-0.3V to ( $V_{CC} + 0.3V$ )
Output Voltage ( $R_{OUT}$ )	-0.3V to ( $V_{CC} + 0.3V$ )
Maximum Package Power Dissipation @ +25°C	
M Package	1025 mW
E Package	1830 mW
Derate M Package	8.2 mW/°C above +25°C
Derate E Package	12.2 mW/°C above +25°C
Storage Temperature Range	-65°C to +150°C
Lead Temperature Range	
Soldering (4 sec.)	+260°C

Maximum Junction Temperature (DS90C032T)	+150°C
Maximum Junction Temperature (DS90C032E)	+175°C
ESD Rating (Note 7)	
(HBM, 1.5 kΩ, 100 pF)	≥ 3,500V
(EIAJ, 0 Ω, 200 pF)	≥ 250V

**Recommended Operating Conditions**

	Min	Typ	Max	Units
Supply Voltage ( $V_{CC}$ )	+4.5	+5.0	+5.5	V
Receiver Input Voltage	GND		2.4	V
Operating Free Air Temperature ( $T_A$ )				
DS90C032T	-40	+25	+85	°C
DS90C032E	-55	+25	+125	°C

**Electrical Characteristics**

Over Supply Voltage and Operating Temperature ranges, unless otherwise specified. (Note 2)

Symbol	Parameter	Conditions	Pin	Min	Typ	Max	Units	
$V_{TH}$	Differential Input High Threshold	$V_{CM} = +1.2V$	$R_{IN+}$			+100	mV	
$V_{TL}$	Differential Input Low Threshold		$R_{IN-}$	-100			mV	
$I_{IN}$	Input Current	$V_{IN} = +2.4V$			±1	+10	μA	
		$V_{IN} = 0V$						$V_{CC} = 5.5V$
$V_{OH}$	Output High Voltage	$I_{OH} = -0.4 mA$ , $V_{ID} = +200 mV$	$R_{OUT}$		4.9		V	
		$I_{OH} = -0.4 mA$ , Input terminated						DS90C032T
$V_{OL}$	Output Low Voltage	$I_{OL} = 2 mA$ , $V_{ID} = -200 mV$			0.07	0.3	V	
$I_{OS}$	Output Short Circuit Current	Enabled, $V_{OUT} = 0V$ (Note 8)		-15	-60	-100	mA	
$I_{OZ}$	Output TRI-STATE Current	Disabled, $V_{OUT} = 0V$ or $V_{CC}$		-10	±1	+10	μA	
$V_{IH}$	Input High Voltage		EN, EN*	2.0		0.8	V	
$V_{IL}$	Input Low Voltage							
$I_I$	Input Current			-10	±1	+10	μA	
$V_{CL}$	Input Clamp Voltage	$I_{CL} = -18 mA$		-1.5	-0.8		V	
$I_{CC}$	No Load Supply Current Receivers Enabled	EN, EN* = $V_{CC}$ or GND,	$V_{CC}$		3.5	10	mA	
		Inputs Open						DS90C032T
		EN, EN* = 2.4 or 0.5, Inputs Open						DS90C032E
$I_{CCZ}$	No Load Supply Current Receivers Disabled	EN = GND, EN* = $V_{CC}$			3.5	10	mA	
		Inputs Open						DS90C032T
					3.5	11	mA	
					3.7	11	mA	
					3.5	10	mA	
					3.5	11	mA	

## Switching Characteristics

$V_{CC} = +5.0V$ ,  $T_A = +25^\circ C$  DS90C032T (Notes 3, 4, 5, 9)

Symbol	Parameter	Conditions	Min	Typ	Max	Units
$t_{PHLD}$	Differential Propagation Delay High to Low	$C_L = 5\text{ pF}$ $V_{ID} = 200\text{ mV}$ (Figure 1 and Figure 2)	1.5	3.40	5.0	ns
$t_{PLHD}$	Differential Propagation Delay Low to High		1.5	3.48	5.0	ns
$t_{SKD}$	Differential Skew $ t_{PHLD} - t_{PLHD} $		0	80	600	ps
$t_{SK1}$	Channel-to-Channel Skew (Note 5)		0	0.6	1.0	ns
$t_{TLH}$	Rise Time			0.5	2.0	ns
$t_{THL}$	Fall Time		0.5	2.0	ns	
$t_{PHZ}$	Disable Time High to Z	$R_L = 2\text{ k}\Omega$		10	15	ns
$t_{PLZ}$	Disable Time Low to Z	$C_L = 10\text{ pF}$		10	15	ns
$t_{PZH}$	Enable Time Z to High	(Figure 3 and Figure 4)		4	10	ns
$t_{PZL}$	Enable Time Z to Low			4	10	ns

## Switching Characteristics

$V_{CC} = +5.0V \pm 10\%$ ,  $T_A = -40^\circ C$  to  $+85^\circ C$  DS90C032T (Notes 3, 4, 5, 6, 9)

Symbol	Parameter	Conditions	Min	Typ	Max	Units
$t_{PHLD}$	Differential Propagation Delay High to Low	$C_L = 5\text{ pF}$ $V_{ID} = 200\text{ mV}$ (Figure 1 and Figure 2)	1.0	3.40	6.0	ns
$t_{PLHD}$	Differential Propagation Delay Low to High		1.0	3.48	6.0	ns
$t_{SKD}$	Differential Skew $ t_{PHLD} - t_{PLHD} $		0	0.08	1.2	ns
$t_{SK1}$	Channel-to-Channel Skew (Note 5)		0	0.6	1.5	ns
$t_{SK2}$	Chip to Chip Skew (Note 6)				5.0	ns
$t_{TLH}$	Rise Time			0.5	2.5	ns
$t_{THL}$	Fall Time			0.5	2.5	ns
$t_{PHZ}$	Disable Time High to Z	$R_L = 2\text{ k}\Omega$		10	20	ns
$t_{PLZ}$	Disable Time Low to Z	$C_L = 10\text{ pF}$		10	20	ns
$t_{PZH}$	Enable Time Z to High	(Figure 3 and Figure 4)		4	15	ns
$t_{PZL}$	Enable Time Z to Low			4	15	ns

## Switching Characteristics

$V_{CC} = +5.0V \pm 10\%$ ,  $T_A = -55^\circ C$  to  $+125^\circ C$  DS90C032E (Notes 3, 4, 5, 6, 9, 10)

Symbol	Parameter	Conditions	Min	Typ	Max	Units
$t_{PHLD}$	Differential Propagation Delay High to Low	$C_L = 20\text{ pF}$ $V_{ID} = 200\text{ mV}$ (Figure 1 and Figure 2)	1.0	3.40	8.0	ns
$t_{PLHD}$	Differential Propagation Delay Low to High		1.0	3.48	8.0	ns
$t_{SKD}$	Differential Skew $ t_{PHLD} - t_{PLHD} $		0	0.08	3.0	ns
$t_{SK1}$	Channel-to-Channel Skew (Note 5)		0	0.6	3.0	ns
$t_{SK2}$	Chip to Chip Skew (Note 6)				7.0	ns
$t_{PHZ}$	Disable Time High to Z	$R_L = 2\text{ k}\Omega$		10	20	ns
$t_{PLZ}$	Disable Time Low to Z	$C_L = 10\text{ pF}$		10	20	ns
$t_{PZH}$	Enable Time Z to High	(Figure 3 and Figure 4)		4	20	ns
$t_{PZL}$	Enable Time Z to Low			4	20	ns

# Parameter Measurement Information

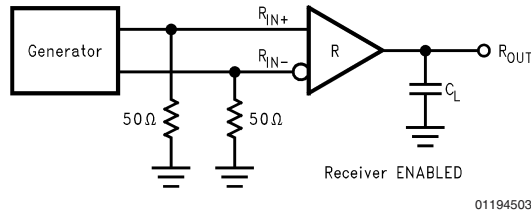

FIGURE 1. Receiver Propagation Delay and Transition Time Test Circuit

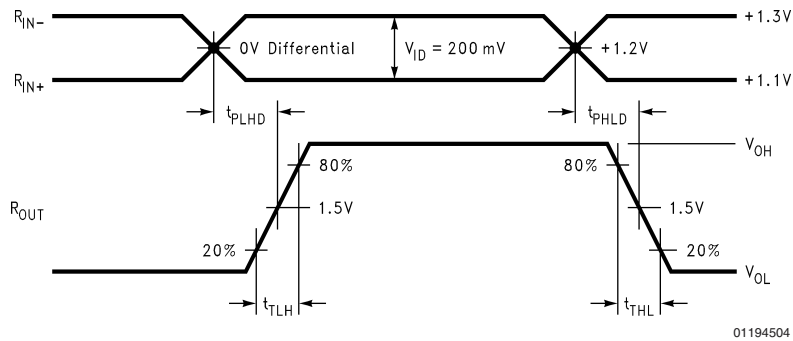
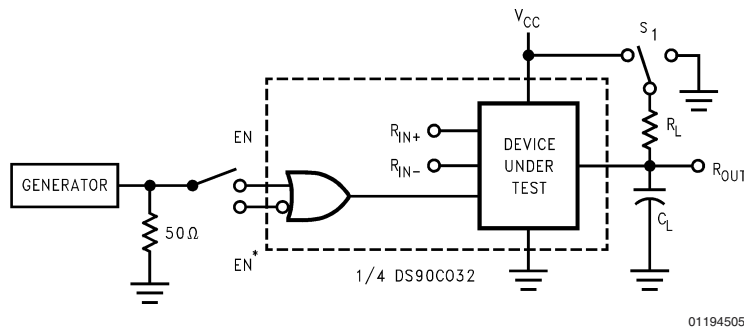

FIGURE 2. Receiver Propagation Delay and Transition Time Waveforms



$C_L$  includes load and test jig capacitance.  
 $S_1 = V_{CC}$  for  $t_{PZL}$  and  $t_{PLZ}$  measurements.  
 $S_1 = GND$  for  $t_{PZH}$  and  $t_{PHZ}$  measurements.

FIGURE 3. Receiver TRI-STATE Delay Test Circuit

## Parameter Measurement Information (Continued)

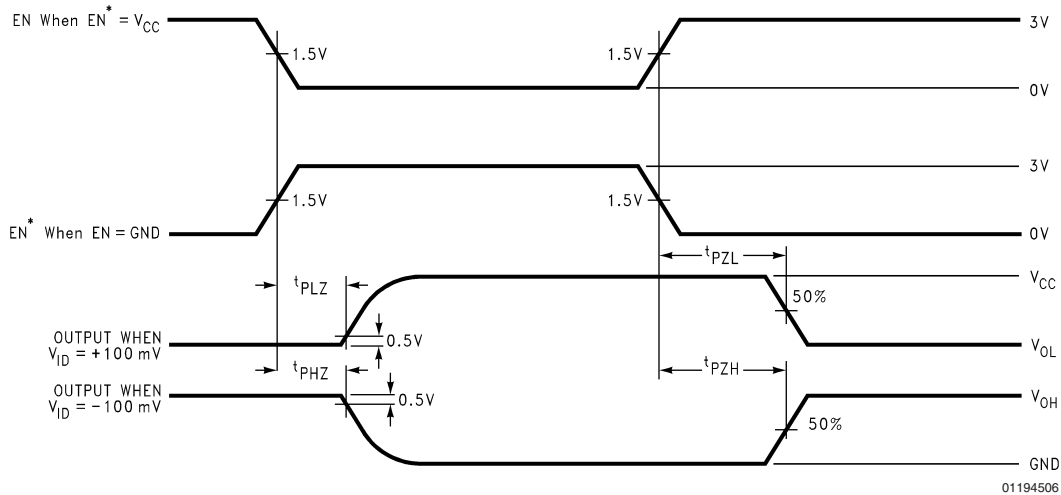

FIGURE 4. Receiver TRI-STATE Delay Waveforms

## Typical Application

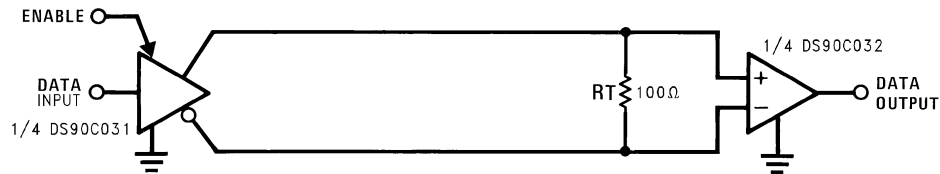

FIGURE 5. Point-to-Point Application

## Applications Information

LVDS drivers and receivers are intended to be primarily used in an uncomplicated point-to-point configuration as is shown in *Figure 5*. This configuration provides a clean signaling environment for the quick edge rates of the drivers. The receiver is connected to the driver through a balanced media which may be a standard twisted pair cable, a parallel pair cable, or simply PCB traces. Typically the characteristic impedance of the media is in the range of 100Ω. A termination resistor of 100Ω should be selected to match the media, and is located as close to the receiver input pins as possible. The termination resistor converts the current sourced by the driver into a voltage that is detected by the receiver. Other configurations are possible such as a multi-receiver configuration, but the effects of a mid-stream connector(s), cable stub(s), and other impedance discontinuities as well as ground shifting, noise margin limits, and total termination loading must be taken into account.

The DS90C032 differential line receiver is capable of detecting signals as low as 100 mV, over a ±1V common-mode range centered around +1.2V. This is related to the driver offset voltage which is typically +1.2V. The driven signal is centered around this voltage and may shift ±1V around this center point. The ±1V shifting may be the result of a ground potential difference between the driver's ground reference and the receiver's ground reference, the common-mode ef-

fects of coupled noise, or a combination of the two. Both receiver input pins should honor their specified operating input voltage range of 0V to +2.4V (measured from each pin to ground), exceeding these limits may turn on the ESD protection circuitry which will clamp the bus voltages.

### Receiver Fail-Safe:

The LVDS receiver is a high gain, high speed device that amplifies a small differential signal (20mV) to CMOS logic levels. Due to the high gain and tight threshold of the receiver, care should be taken to prevent noise from appearing as a valid signal.

The receiver's internal fail-safe circuitry is designed to source/sink a small amount of current, providing fail-safe protection (a stable known state of HIGH output voltage) for floating, terminated or shorted receiver inputs.

1. **Open Input Pins.** The DS90C032 is a quad receiver device, and if an application requires only 1, 2 or 3 receivers, the unused channel(s) inputs should be left OPEN. Do not tie unused receiver inputs to ground or any other voltages. The input is biased by internal high value pull up and pull down resistors to set the output to a HIGH state. This internal circuitry will guarantee a HIGH, stable output state for open inputs.

## Applications Information (Continued)

2. **Terminated Input.** The DS90C032 requires external failsafe biasing for terminated input failsafe. Terminated input failsafe is the case of a receiver that has a  $100\Omega$  termination across its inputs and the driver is in the following situations. Unplugged from the bus, or the driver output is in TRI-STATE or in power-off condition. The use of external biasing resistors provide a small bias to set the differential input voltage while the line is un-driven, and therefore the receiver output will be in HIGH state. If the driver is removed from the bus but the cable is still present and floating, the unplugged cable can become a floating antenna that can pick up noise. The LVDS receiver is designed to detect very small amplitude and width signals and recover them to standard logic levels. Thus, if the cable picks up more than 10mV of differential noise, the receiver may respond. To insure that any noise is seen as common-mode and not differential, a balanced interconnect and twisted pair cables is recommended, as they help to ensure that noise is coupled common to both lines and rejected by the receivers.
3. **Shorted Inputs.** If a fault condition occurs that shorts the receiver inputs together, thus resulting in a 0V differential input voltage, the receiver output will remain in a HIGH state. Shorted input fail-safe is not supported across the common-mode range of the device (1.2V

$\pm 1V$ ). It is only supported with inputs shorted and no external common-mode voltage applied.

4. **Operation in environment with greater than 10mV differential noise.**

National recommends external failsafe biasing on its LVDS receivers for a number of system level and signal quality reasons. First, only an application that requires failsafe biasing needs to employ it. Second, the amount of failsafe biasing is now an application design parameter and can be custom tailored for the specific application. In applications in low noise environments, they may choose to use a very small bias if any. For applications with less balanced interconnects and/or in high noise environments they may choose to boost failsafe further. National's "LVDS Owner's Manual provides detailed calculations for selecting the proper failsafe biasing resistors. Third, the common-mode voltage is biased by the resistors during the un-driven state. This is selected to be close to the nominal driver offset voltage ( $V_{OS}$ ). Thus when switching between driven and un-driven states, the common-mode modulation on the bus is held to a minimum.

For additional Failsafe Biasing information, please refer to Application Note AN-1194 for more detail.

The footprint of the DS90C032 is the same as the industry standard 26LS32 Quad Differential (RS-422) Receiver.

## Pin Descriptions

Pin No. (SOIC)	Name	Description
2, 6, 10, 14	R <sub>IN+</sub>	Non-inverting receiver input pin
1, 7, 9, 15	R <sub>IN-</sub>	Inverting receiver input pin
3, 5, 11, 13	R <sub>OUT</sub>	Receiver output pin
4	EN	Active high enable pin, OR-ed with EN*
12	EN*	Active low enable pin, OR-ed with EN
16	V <sub>CC</sub>	Power supply pin, +5V ± 10%
8	GND	Ground pin

## Ordering Information

Operating Temperature	Package Type/Number	Order Number
-40°C to +85°C	SOP/M16A	DS90C032TM
-55°C to +125°C	LCC/E20A	DS90C032E-QML
DS90C032E-QML (NSID)		
5962-95834 (SMD)		

## Typical Performance Characteristics

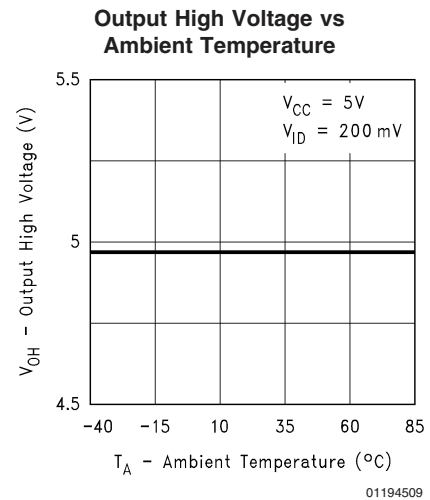
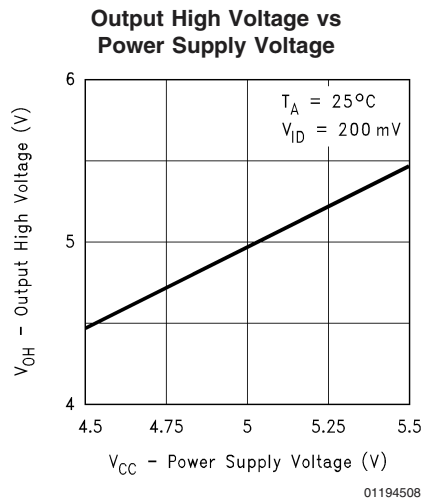

**Note 1:** “Absolute Maximum Ratings” are those values beyond which the safety of the device cannot be guaranteed. They are not meant to imply that the devices should be operated at these limits. The table of “Electrical Characteristics” specifies conditions of device operation.

**Note 2:** Current into device pins is defined as positive. Current out of device pins is defined as negative. All voltages are referenced to ground unless otherwise specified.

**Note 3:** All typicals are given for: V<sub>CC</sub> = +5.0V, T<sub>A</sub> = +25°C.

**Note 4:** Generator waveform for all tests unless otherwise specified: f = 1 MHz, Z<sub>O</sub> = 50Ω, t<sub>r</sub> and t<sub>f</sub> (0%–100%) ≤ 1 ns for R<sub>IN</sub> and t<sub>r</sub> and t<sub>f</sub> ≤ 6 ns for EN or EN\*.

**Note 5:** Channel-to-Channel Skew is defined as the difference between the propagation delay of one channel and that of the others on the same chip with an event on the inputs.

**Note 6:** Chip to Chip Skew is defined as the difference between the minimum and maximum specified differential propagation delays.

**Note 7:** ESD Rating:

HBM (1.5 kΩ, 100 pF) ≥ 3,500V

IEAJ (0Ω, 200 pF) ≥ 250V

**Note 8:** Output short circuit current (I<sub>OS</sub>) is specified as magnitude only, minus sign indicates direction only. Only one output should be shorted at a time, do not exceed maximum junction temperature specification.

**Note 9:** C<sub>L</sub> includes probe and jig capacitance.

**Note 10:** For DS90C032E propagation delay measurements are from 0V on the input waveform to the 50% point on the output (R<sub>OUT</sub>).

Typical Performance Characteristics (Continued)

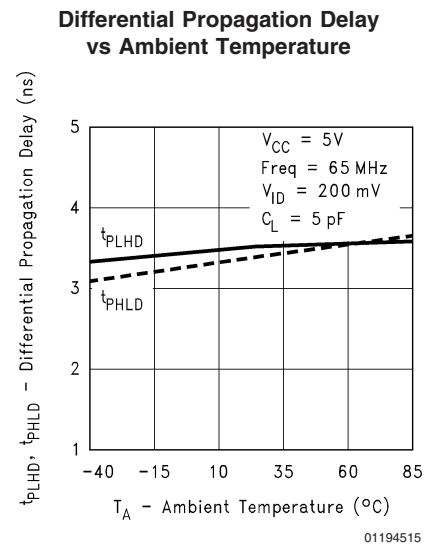
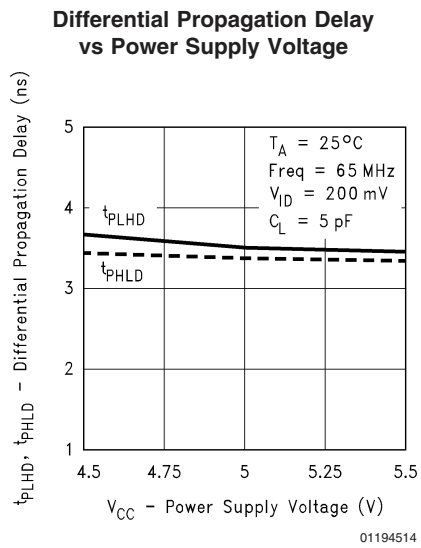
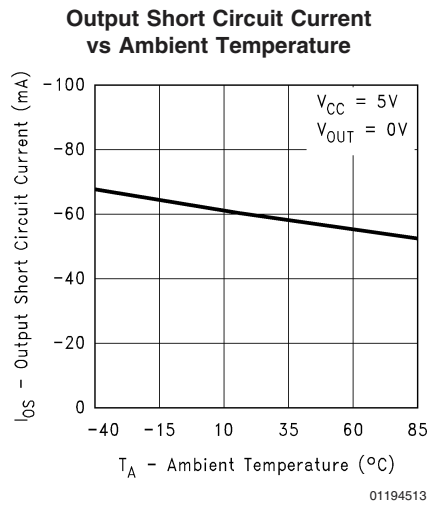
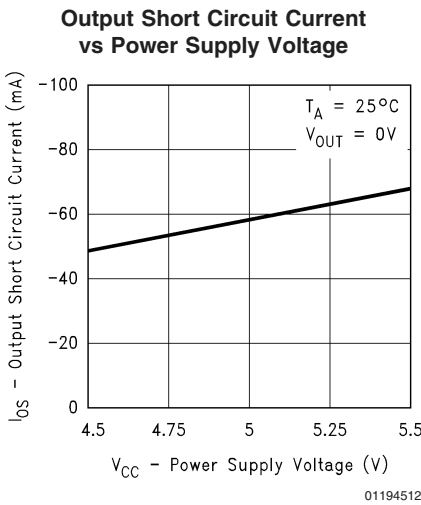
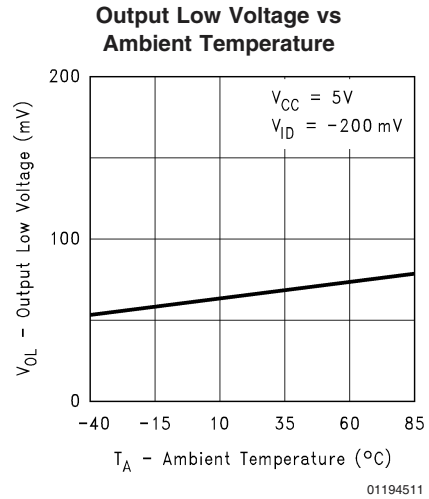
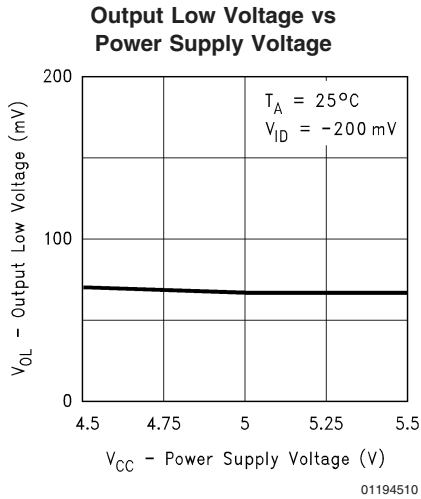

Typical Performance Characteristics (Continued)

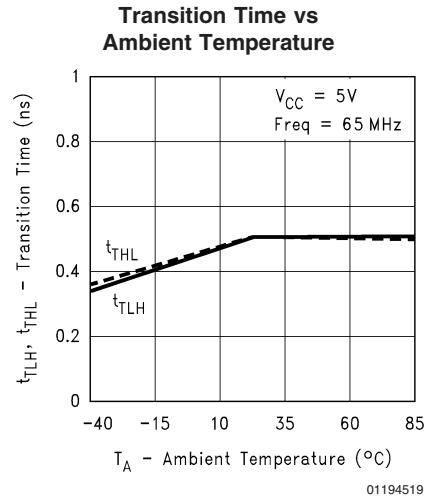
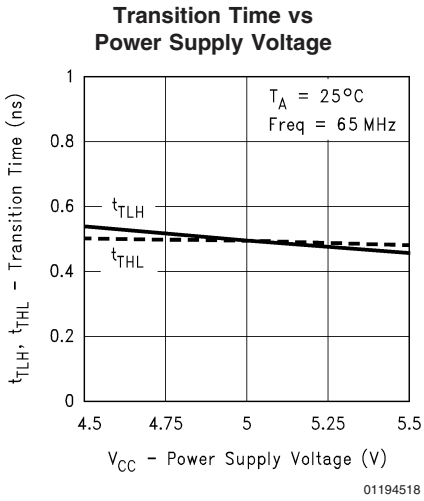
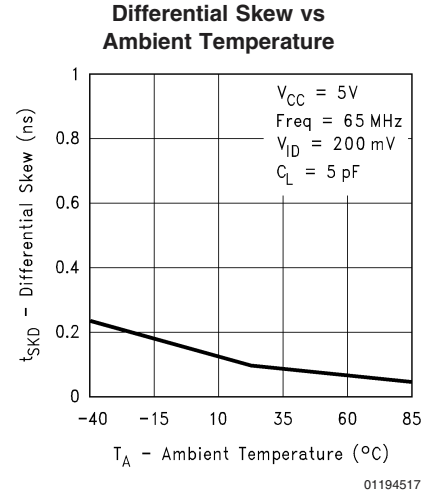
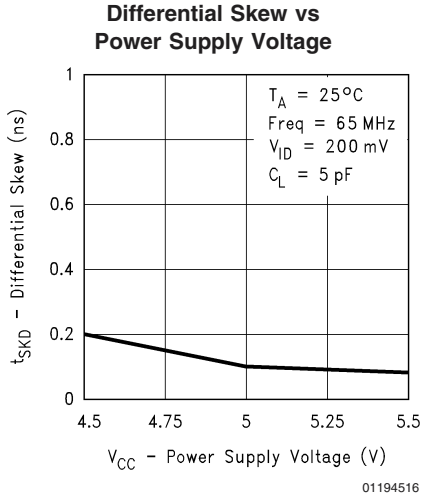

**Physical Dimensions** inches (millimeters)

unless otherwise noted

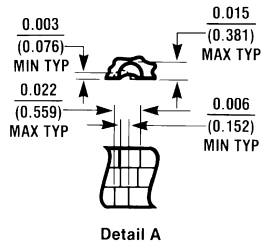
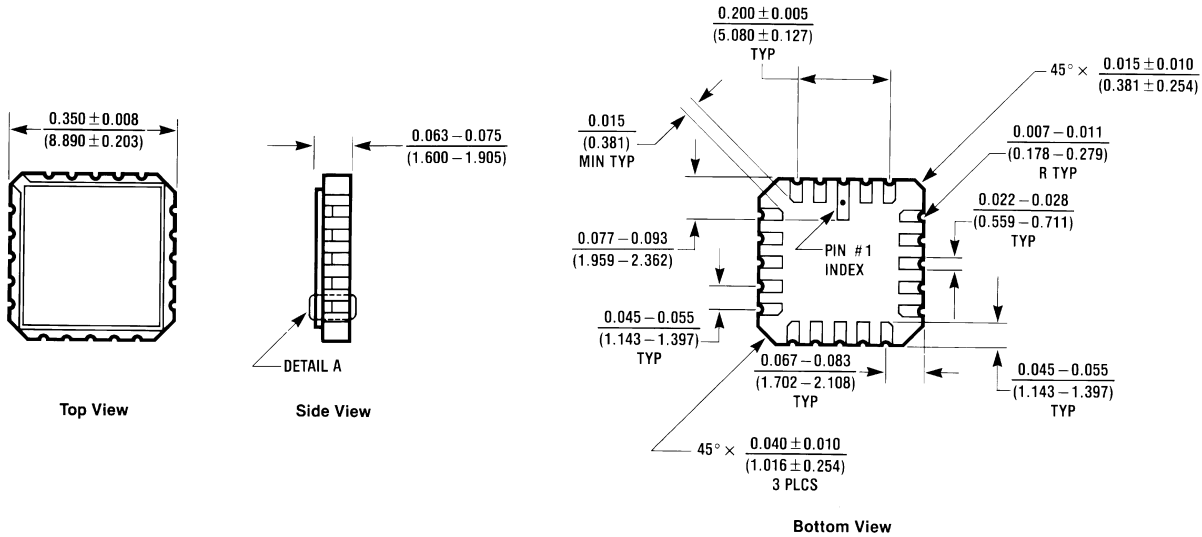

E20A (REV D)

**20-Lead Ceramic Leadless Chip Carrier, Type C**  
**Order Number DS90C032E-QML**  
**NS Package Number E20A**

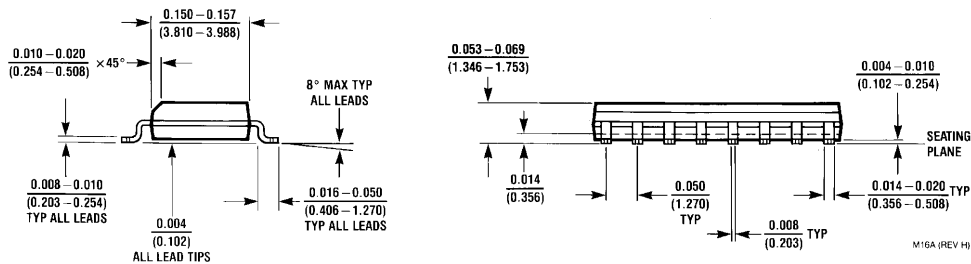
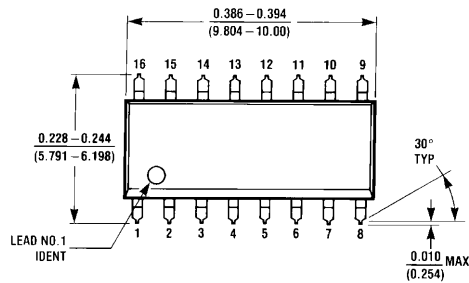

M16A (REV H)

**16-Lead (0.150" Wide) Molded Small Outline Package, JEDEC**  
**Order Number DS90C032TM**  
**NS Package Number M16A**

## Notes

### LIFE SUPPORT POLICY

NATIONAL'S PRODUCTS ARE NOT AUTHORIZED FOR USE AS CRITICAL COMPONENTS IN LIFE SUPPORT DEVICES OR SYSTEMS WITHOUT THE EXPRESS WRITTEN APPROVAL OF THE PRESIDENT AND GENERAL COUNSEL OF NATIONAL SEMICONDUCTOR CORPORATION. As used herein:

1. Life support devices or systems are devices or systems which, (a) are intended for surgical implant into the body, or (b) support or sustain life, and whose failure to perform when properly used in accordance with instructions for use provided in the labeling, can be reasonably expected to result in a significant injury to the user.
2. A critical component is any component of a life support device or system whose failure to perform can be reasonably expected to cause the failure of the life support device or system, or to affect its safety or effectiveness.



**National Semiconductor**  
**Americas Customer**  
**Support Center**  
 Email: new.feedback@nsc.com  
 Tel: 1-800-272-9959

[www.national.com](http://www.national.com)

**National Semiconductor**  
**Europe Customer Support Center**  
 Fax: +49 (0) 180-530 85 86  
 Email: europe.support@nsc.com  
 Deutsch Tel: +49 (0) 69 9508 6208  
 English Tel: +44 (0) 870 24 0 2171  
 Français Tel: +33 (0) 1 41 91 8790

**National Semiconductor**  
**Asia Pacific Customer**  
**Support Center**  
 Email: ap.support@nsc.com

**National Semiconductor**  
**Japan Customer Support Center**  
 Fax: 81-3-5639-7507  
 Email: jpn.feedback@nsc.com  
 Tel: 81-3-5639-7560

# National Semiconductor was acquired by Texas Instruments.

[http://www.ti.com/corp/docs/investor\\_relations/pr\\_09\\_23\\_2011\\_national\\_semiconductor.html](http://www.ti.com/corp/docs/investor_relations/pr_09_23_2011_national_semiconductor.html)

This file is the datasheet for the following electronic components:

5962-9583401VFA - <http://www.ti.com/product/5962-9583401vfa?HQS=TI-null-null-dscatalog-df-pf-null-wwe>

5962-9583401Q2A - <http://www.ti.com/product/5962-9583401q2a?HQS=TI-null-null-dscatalog-df-pf-null-wwe>

DS90C032W-MLS - <http://www.ti.com/product/ds90c032w-mls?HQS=TI-null-null-dscatalog-df-pf-null-wwe>

5962L9583401VFA - <http://www.ti.com/product/5962L9583401vfa?HQS=TI-null-null-dscatalog-df-pf-null-wwe>

DS90C032WGLQMLV - <http://www.ti.com/product/ds90c032wglqmlv?HQS=TI-null-null-dscatalog-df-pf-null-wwe>

DS90C032WG-QMLV - <http://www.ti.com/product/ds90c032wg-qmlv?HQS=TI-null-null-dscatalog-df-pf-null-wwe>

DS90C032TM - <http://www.ti.com/product/ds90c032tm?HQS=TI-null-null-dscatalog-df-pf-null-wwe>

DS90C032 MDC - [http://www.ti.com/product/ds90c032\\_mdc?HQS=TI-null-null-dscatalog-df-pf-null-wwe](http://www.ti.com/product/ds90c032_mdc?HQS=TI-null-null-dscatalog-df-pf-null-wwe)

DS90C032 MD8 - [http://www.ti.com/product/ds90c032\\_md8?HQS=TI-null-null-dscatalog-df-pf-null-wwe](http://www.ti.com/product/ds90c032_md8?HQS=TI-null-null-dscatalog-df-pf-null-wwe)

DS90C032TMX - <http://www.ti.com/product/ds90c032tmx?HQS=TI-null-null-dscatalog-df-pf-null-wwe>



LittleDiode supplies new, hard to find or obsolete electronic components and semiconductors all over the world.

With over two million different components listed you are sure to find the part you need.

Feel free to visit us today at our online store:

[LittleDiode.com](http://LittleDiode.com)

Looking forward to providing you with the best possible service.