

## Features

- Clocking Speeds up to 40MHz
- 15ns tr/tf at 2000pF C<sub>LOAD</sub>
- 0.5ns Rise and Fall Times Mismatch
- 0.5ns T<sub>ON</sub>-T<sub>OFF</sub> Prop Delay Mismatch
- 3.5pF Typical Input Capacitance
- 3.5A Peak Drive
- Low on Resistance of 3.5Ω
- High Capacitive Drive Capability
- Operates from 4.5V up to 18V

## Applications

- ATE/Burn-in Testers
- Level Shifting
- IGBT Drivers
- CCD Drivers

## Ordering Information

Part No.	Package	Tape & Reel	Outline #
EL7155CN	8-Pin DIP	-	MDP0031
EL7155CS	8-Pin SOIC	-	MDP0027
EL7155CS-T7	8-Pin SOIC	7"	MDP0027
EL7155CS-T13	8-Pin SOIC	13"	MDP0027

## General Description

The EL7155C high-performance pin driver with tri-state is suited to many ATE and level-shifting applications. The 3.5A peak drive capability makes this part an excellent choice when driving high capacitance loads.

Output pins OUTH and OUTL are connected to input pins VH and VL respectively, depending on the status of the IN pin. One of the output pins is always in tri-state, except when the OE pin is active low, in which case both outputs are in tri-state mode. The isolation of the output FETs from the power supplies enables VH and VL to be set independently, enabling level-shifting to be implemented.

This pin driver has improved performance over existing pin drivers. It is specifically designed to operate at voltages down to 0V across the switch elements while maintaining good speed and on-resistance characteristics.

Available in the 8-Pin SOIC and 8-Pin PDIP packages, the EL7155C is specified for operation over the -40°C to +85°C temperature range.

## Pin Layout Diagram

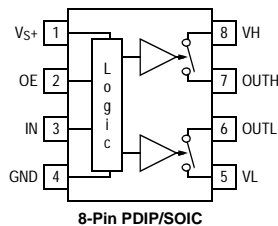

# EL7155C

## High-Performance Pin Driver

### Absolute Maximum Ratings (T<sub>A</sub> = 25°C)

Absolute maximum ratings are those values beyond which the device could be permanently damaged. Absolute maximum ratings are stress ratings only and functional device operation is not implied.

Supply Voltage (V <sub>S+</sub> to VL)	+18V
Input Voltage	VL -0.3V, VL+ +0.3V
Continuous Output Current	200mA

Storage Temperature Range	-65°C to +150°C
Ambient operating Temperature	-40°C to +85°C
Operating Junction Temperature	125°C
Power Dissipation	see curves
Maximum ESD	2kV

#### Important Note:

All parameters having Min/Max specifications are guaranteed. Typ values are for information purposes only. Unless otherwise noted, all tests are at the specified temperature and are pulsed tests, therefore: T<sub>J</sub> = T<sub>C</sub> = T<sub>A</sub>.

### Electrical Characteristics

V<sub>S+</sub> = +15V, V<sub>H</sub> = +15V, V<sub>L</sub> = 0V, T<sub>A</sub> = 25°C, unless otherwise specified.

Parameter	Description	Condition	Min	Typ	Max	Unit
<b>Input</b>						
V <sub>IH</sub>	Logic '1' Input Voltage		2.4			V
I <sub>IH</sub>	Logic '1' Input Current	V <sub>IH</sub> = V <sub>S+</sub>		0.1	10	μA
V <sub>IL</sub>	Logic '0' Input Voltage				0.8	V
I <sub>IL</sub>	Logic '0' Input Current	V <sub>IL</sub> = 0V		0.1	10	μA
C <sub>IN</sub>	Input Capacitance			3.5		pF
R <sub>IN</sub>	Input Resistance			50		MΩ
<b>Output</b>						
R <sub>OVH</sub>	ON Resistance V <sub>H</sub> to OUTH	I <sub>OUT</sub> = -200 mA		2.7	4.5	Ω
R <sub>OVL</sub>	ON Resistance V <sub>L</sub> to OUTL	I <sub>OUT</sub> = +200 mA		3.5	5.5	Ω
I <sub>OUT</sub>	Output Leakage Current	OE = 0V, OUTH = V <sub>L</sub> , OUTL = V <sub>S+</sub>		0.1	10	μA
I <sub>PK</sub>	Peak Output Current (linear resistive operation)	Source		3.5		A
		Sink		3.5		A
I <sub>DC</sub>	Continuous Output Current	Source/Sink	200			mA
<b>Power Supply</b>						
I <sub>S</sub>	Power Supply Current	Inputs = V <sub>S+</sub>		1.3	3	mA
I <sub>VH</sub>	Off Leakage at V <sub>H</sub>	V <sub>H</sub> = 0V		4	10	μA
<b>Switching Characteristics</b>						
t <sub>R</sub>	Rise Time	C <sub>L</sub> = 2000 pF		14.5		ns
t <sub>F</sub>	Fall Time	C <sub>L</sub> = 2000 pF		15		ns
t <sub>Rdelta</sub>	t <sub>R</sub> , t <sub>F</sub> Mismatch	C <sub>L</sub> = 2000 pF		0.5		ns
t <sub>D-1</sub>	Turn-Off Delay Time	C <sub>L</sub> = 2000 pF		9.5		ns
t <sub>D-2</sub>	Turn-On Delay Time	C <sub>L</sub> = 2000 pF		10		ns
t <sub>Ddelta</sub>	t <sub>D-1</sub> -t <sub>D-2</sub> Mismatch	C <sub>L</sub> = 2000 pF		0.5		ns
t <sub>D-3</sub>	Tri-State Delay Enable			10		ns
t <sub>D-4</sub>	Tri-State Delay Disable			10		ns

## Electrical Characteristics

$V_{S+} = +5V$ ,  $V_H = +5V$ ,  $V_L = -5V$ ,  $T_A = 25^\circ C$ , unless otherwise specified.

Parameter	Description	Condition	Min	Typ	Max	Unit
<b>Input</b>						
$V_{IH}$	Logic '1' Input Voltage		2.0			V
$I_{IH}$	Logic '1' Input Current	$V_{IH} = V_{S+}$		0.1	10	$\mu A$
$V_{IL}$	Logic '0' Input Voltage				0.8	V
$I_{IL}$	Logic '0' Input Current	$V_{IL} = 0V$		0.1	10	$\mu A$
$C_{IN}$	Input Capacitance			3.5		pF
$R_{IN}$	Input Resistance			50		$M\Omega$
<b>Output</b>						
$R_{OVH}$	ON Resistance $V_H$ to OUTH	$I_{OUT} = -200 mA$		3.4	5	$\Omega$
$R_{OVL}$	ON Resistance $V_L$ to OUTL	$I_{OUT} = +200 mA$		4	6	$\Omega$
$I_{OUT}$	Output Leakage Current	$OE = 0V$ , OUTH = $V_L$ , OUTL = $V_{S+}$		0.1	10	$\mu A$
$I_{PK}$	Peak Output Current (linear resistive operation)	Source		3.5		A
		Sink		3.5		A
$I_{DC}$	Continuous Output Current	Source/Sink	200			mA
<b>Power Supply</b>						
$I_S$	Power Supply Current	Inputs = $V_{S+}$		1	2.5	mA
$I_{VH}$	Off Leakage at $V_H$	$V_H = 0V$		4	10	$\mu A$
<b>Switching Characteristics</b>						
$t_R$	Rise Time	$C_L = 2000 pF$		17		ns
$t_F$	Fall Time	$C_L = 2000 pF$		17		ns
$t_{RF\Delta}$	$t_R$ , $t_F$ Mismatch	$C_L = 2000 pF$		0		ns
$t_{D-1}$	Turn-Off Delay Time	$C_L = 2000 pF$		11.5		ns
$t_{D-2}$	Turn-On Delay Time	$C_L = 2000 pF$		12		ns
$t_{D\Delta}$	$t_{D-1}$ - $t_{D-2}$ Mismatch	$C_L = 2000 pF$		0.5		ns
$t_{D-3}$	Tri-State Delay Enable			11		ns
$t_{D-4}$	Tri-State Delay Disable			11		ns

# EL7155C

## High-Performance Pin Driver

### Typical Performance Curves

Max Power/Derating Curves

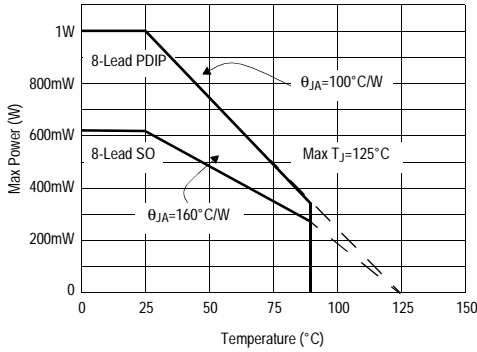

Input Threshold vs Supply Voltage  
 $T = 25^\circ\text{C}$

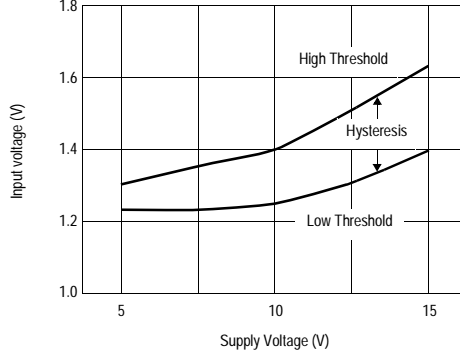

Quiescent Supply Current vs Supply Voltage  
 $T = 25^\circ\text{C}$

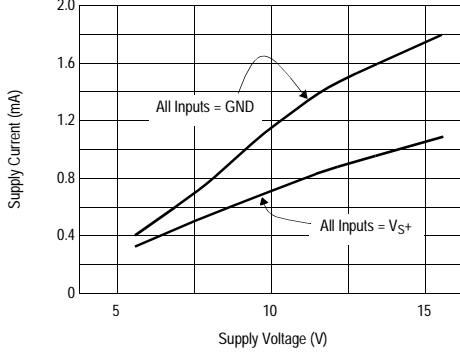

"On" Resistance vs Supply Voltage  
 $I_{\text{OUT}} = 200\text{mA}, T = 25^\circ\text{C}, V_{S+} = V_{\text{H}}, V_{\text{L}} = 0\text{V}$

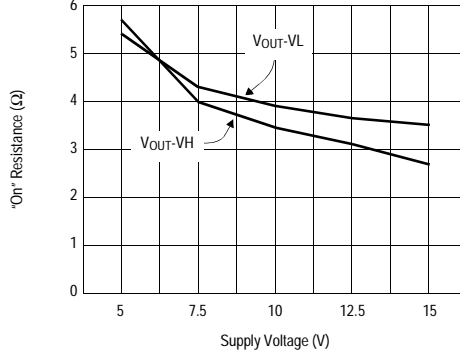

Rise/Fall Time vs Supply Voltage  
 $C_{\text{L}} = 2000\text{pF}, T = 25^\circ\text{C}$

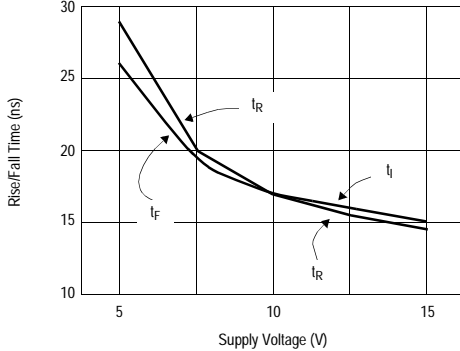

Rise/Fall Time vs Temperature  
 $C_{\text{L}} = 2000\text{pF}, V_{\text{S+}} = 15\text{V}$

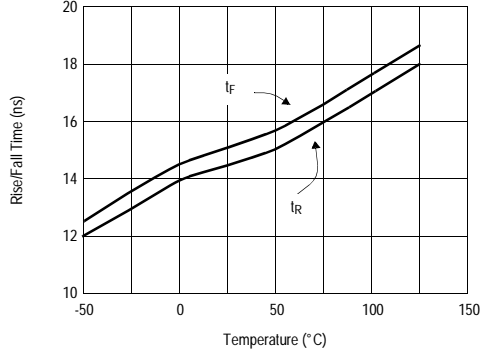

### Typical Performance Curves (cont.)

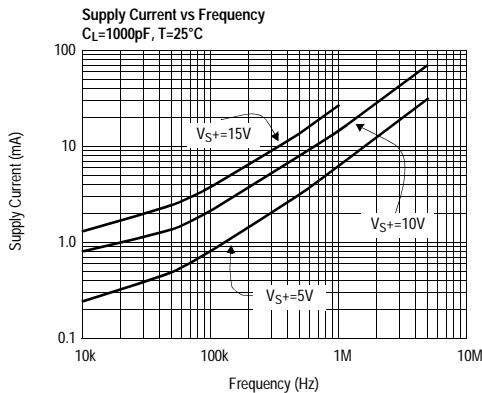
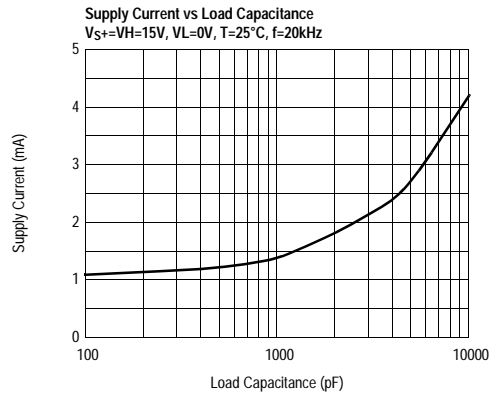
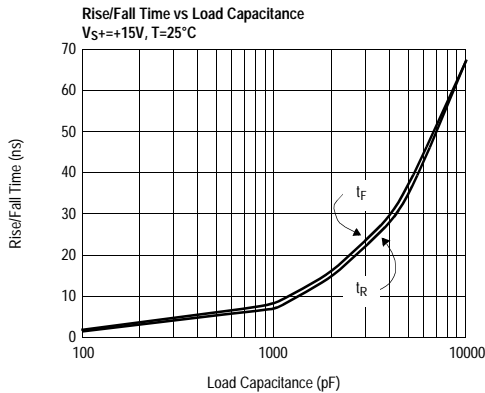
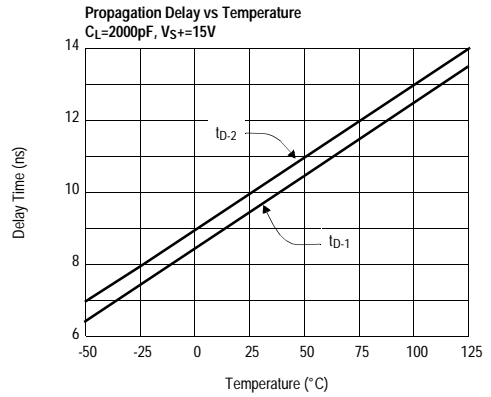
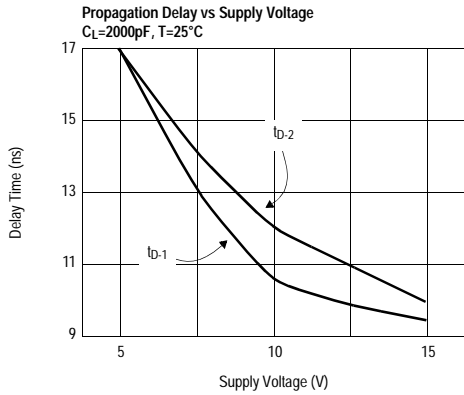

# EL7155C

## High-Performance Pin Driver

### Truth Table

OE	IN	VH to OUTH	OUTL to VS-
0	0	Open	Open
0	1	Open	Open
1	0	Closed	Open
1	1	Open	Closed

### Operating Voltage Range

PIN	MIN	MAX
GND - VL	-5	0
VS+ - VL	5	18
VH - VL	0	18
VS+ - VH	0	18
VS+ - GND	5	18

### Timing Diagrams

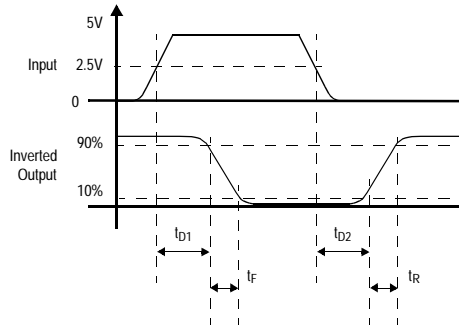

### Standard Test Configuration

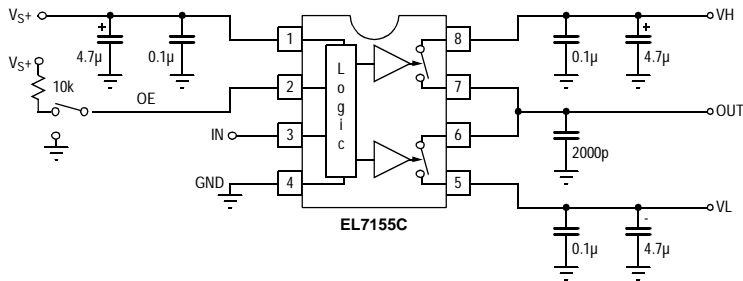

## Pin Descriptions

Pin	Name	Function	Equivalent Circuit
1	V <sub>S+</sub>	Positive Supply Voltage	
2	OE	Output Enable	<p style="text-align: center;"><b>Circuit 1</b></p>
3	IN	Input	Same as Circuit 1
4	GND	Ground	
5	V <sub>L</sub>	Negative Supply Voltage	
6	OUTL	Lower Switch Output	<p style="text-align: center;"><b>Circuit 2</b></p>
7	OUTH	Upper Switch Output	<p style="text-align: center;"><b>Circuit 3</b></p>
8	V <sub>H</sub>	Upper Output Voltage	

# EL7155C

High-Performance Pin Driver

## Block Diagram

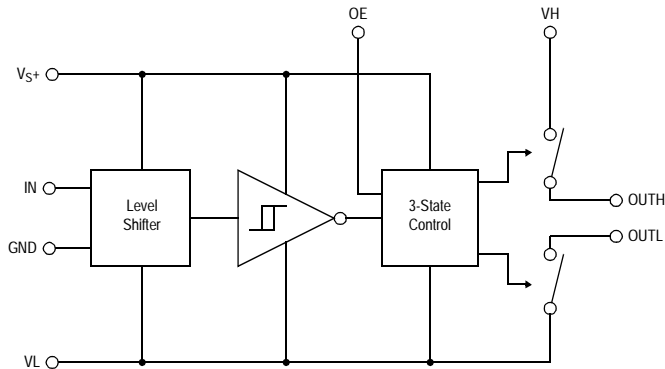

## Application Information

### Product Description

The EL7155C is a high performance 40MHz pin driver. It contains two analog switches connecting VH to OUTH and VL to OUTL. Depending on the value of the IN pin, one of the two switches will be closed and the other switch open. An output enable (OE) is also supplied which opens both switches simultaneously.

Due to the topology of the EL7155C, VL should always be connected to a voltage equal to, or lower than GND. VH can be connected to any voltage between VL and the positive supply,  $V_{S+}$ .

The EL7155C is available in both the 8-pin SOIC and the 8-pin PDIP packages. The relevant package should be chosen depending on the calculated power dissipation.

### Supply Voltage Range and Input Compatibility

The EL7155C is designed for operation on supplies from 5V to 15V (4.5V to 18V maximum). The table on page 6 shows the specifications for the relationship between the  $V_{S+}$ , VH, VL, and GND pins.

All input pins are compatible with both 3V and 5V CMOS signals. With a positive supply ( $V_{S+}$ ) of 5V, the EL7155C is also compatible with TTL inputs.

### Power Supply Bypassing

When using the EL7155C, it is very important to use adequate power supply bypassing. The high switching currents developed by the EL7155C necessitate the use of a bypass capacitor between the  $V_{S+}$  and GND pins. It is recommended that a 2.2 $\mu$ F tantalum capacitor be used in parallel with a 0.1 $\mu$ F low-inductance ceramic MLC capacitor. These should be placed as close to the supply pins as possible. It is also recommended that the VH and VL pins have some level of bypassing, especially if the EL7155C is driving highly capacitive loads.

### Power Dissipation Calculation

When switching at high speeds, or driving heavy loads, the EL7155C drive capability is limited by the rise in die temperature brought about by internal power dissipation. For reliable operation die temperature must be kept below  $T_{jmax}$  (125°C). It is necessary to calculate the power dissipation for a given application prior to selecting the package type.

Power dissipation may be calculated:

$$PD = (V_S \times I_S) + (C_{INT} \times V_S^2 \times f) + (C_L \times V_{OUT}^2 \times f)$$

where:

- $V_S$  is the total power supply to the EL7155C (from  $V_{S+}$  to GND),
- $V_{out}$  is the swing on the output (VH - VL),
- $C_L$  is the load capacitance,
- $C_{INT}$  is the internal load capacitance (50pF max.),

- $I_S$  is the quiescent supply current (3mA max.) and
- $f$  is frequency

Having obtained the application's power dissipation, a maximum package thermal coefficient may be determined, to maintain the internal die temperature below  $T_{jmax}$ :

$$\theta_{ja} = \frac{(T_{jmax} - T_{max})}{PD}$$

where:

- $T_{jmax}$  is the maximum junction temperature (125°C),
- $T_{max}$  is the maximum operating temperature,
- PD is the power dissipation calculated above,
- $\theta_{ja}$  thermal resistance on junction to ambient.

$\theta_{ja}$  is 160°C/W for the SO8 package and 100°C/W for the PDIP8 package when using a standard JEDEC JESD51-3 single-layer test board. If  $T_{jmax}$  is greater than 125°C when calculated using the equation above, then one of the following actions must be taken:

- Reduce  $\theta_{ja}$  the system by designing more heat-sinking into the PCB (as compared to the standard JEDEC JESD51-3)
- Use the PDIP8 instead of the SO8 package
- De-rate the application either by reducing the switching frequency, the capacitive load, or the maximum operating (ambient) temperature ( $T_{max}$ )

# EL7155C

*High-Performance Pin Driver*

## General Disclaimer

Specifications contained in this data sheet are in effect as of the publication date shown. Elantec, Inc. reserves the right to make changes in the circuitry or specifications contained herein at any time without notice. Elantec, Inc. assumes no responsibility for the use of any circuits described herein and makes no representations that they are free from patent infringement.

***élantec***

HIGH PERFORMANCE ANALOG INTEGRATED CIRCUITS

## Elantec Semiconductor, Inc.

675 Trade Zone Blvd.

Milpitas, CA 95035

Telephone: (408) 945-1323

(888) ELANTEC

Fax: (408) 945-9305

European Office: +44-118-977-6080

Japan Technical Center: +81-45-682-5820

## WARNING - Life Support Policy

Elantec, Inc. products are not authorized for and should not be used within Life Support Systems without the specific written consent of Elantec, Inc. Life Support systems are equipment intended to support or sustain life and whose failure to perform when properly used in accordance with instructions provided can be reasonably expected to result in significant personal injury or death. Users contemplating application of Elantec, Inc. Products in Life Support Systems are requested to contact Elantec, Inc. factory headquarters to establish suitable terms & conditions for these applications. Elantec, Inc.'s warranty is limited to replacement of defective components and does not cover injury to persons or property or other consequential damages.



LittleDiode supplies new, hard to find or obsolete electronic components and semiconductors all over the world.

With over two million different components listed you are sure to find the part you need.

Feel free to visit us today at our online store:

[LittleDiode.com](http://LittleDiode.com)

Looking forward to providing you with the best possible service.