

**Features**

- Four independent fast PNP's
- 350 MHz  $f_t$
- Tight  $V_{BE}$  matching—1 mV
- Tight  $H_{fe}$  matching—5%
- One chip construction with dielectric isolation
- Excellent thermal tracking
- High  $H_{fe}$ —150 minimum
- 40V minimum  $BV_{ceo}$
- Each transistor similar to 2N3906
- Pin compatible with TPQ3906 and MPQ3906

**Applications**

- Current sources
- Current mirrors
- Log amplifiers
- Multipliers

**Ordering Information**

Part No.	Temp. Range	Package	Outline#
EP2015CN	0°C to +75°C	P-DIP	MDP0031
EP2015ACN	0°C to +75°C	P-DIP	MDP0031
EP2015CM	0°C to +75°C	20-Lead SOL	MDP0027

**General Description**

The EP2015 family are quad monolithic vertical PNP transistor arrays which offer excellent parametric matching and high speed performance. The 350 MHz  $f_t$  provides A.C. performance similar to 2N3906 class devices. Manufactured on Elantec's Complementary Bipolar process, these transistors are electrically isolated from each other by a layer of oxide. The resulting low collector to substrate capacitance allows very high speed performance with minimal crosstalk. In addition, complete D.C. isolation is achieved. Substrate biasing is not required for normal operation, however for optimum high speed performance the substrate should be grounded. One-chip construction insures excellent parameter matching and tracking over temperature.

The low cost EP2015C is specified at 25°C. The EP2015AC is more tightly specified and guaranteed over the commercial temperature range of 0°C to +75°C. The EP2015C and EP2015AC are available in 14-pin plastic dual-in-line packages.

For information on a complementary NPN transistor array, see Elantec's EN2016 family data sheet.

Elantec facilities comply with MIL-I-45208A and other applicable quality specifications. For information on Elantec's processing, request our brochure, QRA1: *Elantec's Processing—Monolithic Products.*

**Connection Diagrams**

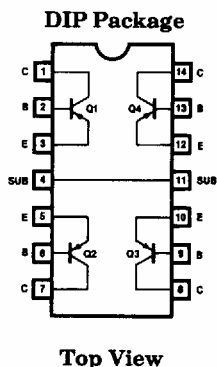

2015-1

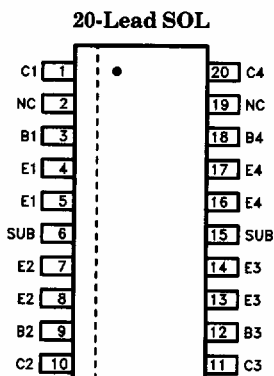

2015-13

**Isolation Characteristics Test Circuit**

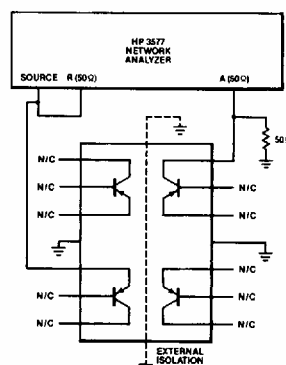

2015-2

# EP2015C/EP2015AC

## Fast Quad PNP Array

### Absolute Maximum Ratings

$P_D$	Power Dissipation		$T_{ST}$	Storage Temperature	-65°C to +150°C
	Each Transistor	500 mW ( $T_A = 25^\circ\text{C}$ )		Lead Temperature	
	Total Package	1.25W ( $T_A = 25^\circ\text{C}$ )		SOL Package	
$T_A$	Operating Temperature Range	-0°C to +75°C		Vapor Phase (60 seconds)	215°C
$T_J$	Maximum Junction Temperature	150°C		Infrared (15 seconds)	220°C
				(Soldering, <10 seconds)	300°C
			$V_{CB}$	Max	40V
			$V_{EB}$	Max	5V
			$V_{CE}$	Max	40V
			$I_C$	Max	50 mA
			$I_B$	Max	10 mA

**Important Note:**

All parameters having Min/Max specifications are guaranteed. The Test Level column indicates the specific device testing actually performed during production and Quality inspection. Elantec performs most electrical tests using modern high-speed automatic test equipment, specifically the LTX77 Series system. Unless otherwise noted, all tests are pulsed tests, therefore  $T_J = T_C = T_A$ .

Test Level	Test Procedure
I	100% production tested and QA sample tested per QA test plan QCX0002.
II	100% production tested at $T_A = 25^\circ\text{C}$ and QA sample tested at $T_A = 25^\circ\text{C}$ , $T_{MAX}$ and $T_{MIN}$ per QA test plan QCX0002.
III	QA sample tested per QA test plan QCX0002.
IV	Parameter is guaranteed (but not tested) by Design and Characterization Data.
V	Parameter is typical value at $T_A = 25^\circ\text{C}$ for information purposes only.

### Electrical Characteristics

Parameter	Description	Test Conditions	EP2015C				Units
			Min	Typ	Max	Test Level	
$\Delta V_{BE}$	(Note 1)	$V_{CE} = 4V, I_C = 1\text{ mA}$ $T_A = 25^\circ\text{C}$			5	I	mV
		$T_{MIN} < T_A < T_{MAX}$					mV
$\Delta H_{fe1}$	(Notes 1, 2)	$V_{CE} = 1V, I_C = 0.1\text{ mA}$ $T_A = 25^\circ\text{C}$			10	I	%
		$T_{MIN} < T_A < T_{MAX}$					%
$\Delta H_{fe2}$	(Notes 1, 2)	$V_{CE} = 1V, I_C = 1\text{ mA}$ $T_A = 25^\circ\text{C}$			10	I	%
		$T_{MIN} < T_A < T_{MAX}$					%
$\Delta H_{fe3}$	(Notes 1, 2)	$V_{CE} = 1V, I_C = 10\text{ mA}$ $T_A = 25^\circ\text{C}$			10	I	%
		$T_{MIN} < T_A < T_{MAX}$					%
$H_{fe1}$	(Note 3)	$V_{CE} = 1V, I_C = 0.1\text{ mA}$ $T_A = 25^\circ\text{C}$	75			I	
		$T_{MIN} < T_A < T_{MAX}$					
$H_{fe2}$	(Note 3)	$V_{CE} = 1V, I_C = 1.0\text{ mA}$ $T_A = 25^\circ\text{C}$	75			I	
		$T_{MIN} < T_A < T_{MAX}$					

# EP2015C/EP2015AC

## Fast Quad PNP Array

EP2015C/EP2015AC

### Electrical Characteristics — Contd.

Parameter	Description	Test Conditions	EP2015				Units
			Min	Typ	Max	Test Level	
$H_{fe3}$	(Note 3)	$V_{CE} = 1V, I_C = 10\text{ mA}$ $T_A = 25^\circ\text{C}$	75			I	
		$T_{MIN} < T_A < T_{MAX}$					
$V_{BEsat}$	(Note 3)	$I_C = 10\text{ mA}, I_B = 1\text{ mA}$ $T_A = 25^\circ\text{C}$			0.90	I	V
		$T_{MIN} < T_A < T_{MAX}$					V
$V_{CEsat}$	(Note 3)	$I_C = 10\text{ mA}, I_B = 1\text{ mA}$ $T_A = 25^\circ\text{C}$			0.20	I	V
		$T_{MIN} < T_A < T_{MAX}$					V
$BV_{ceo}$	(Note 3)	$I_C = 1\text{ mA}, I_B = 0\text{ mA}$ $T_A = 25^\circ\text{C}$	40			I	V
		$T_{MIN} < T_A < T_{MAX}$					V
$BV_{cbo}$	(Note 3)	$I_C = 10\text{ }\mu\text{A}, I_E = 0\text{ mA}$ $T_A = 25^\circ\text{C}$	40			I	V
		$T_{MIN} < T_A < T_{MAX}$					V
$BV_{ebo}$	(Note 3)	$I_B = 10\text{ }\mu\text{A}, I_C = 0\text{ mA}$ $T_A = 25^\circ\text{C}$	5			I	V
		$T_{MIN} < T_A < T_{MAX}$					V
$I_{cbo}$	(Note 3)	$V_{CB} = 30V, I_E = 0\text{ mA}$ $T_A = 25^\circ\text{C}$			50	I	nA
		$T_{MIN} < T_A < T_{MAX}$					nA
$I_{ebo}$	(Note 3)	$V_{CE} = 4V, I_C = 0\text{ mA}$ $T_A = 25^\circ\text{C}$			50	I	nA
		$T_{MIN} < T_A < T_{MAX}$					nA
$f_t$	(Note 3)	$V_{CE} = 20V, I_C = 10\text{ mA}$ $T_A = 25^\circ\text{C}$		350		V	MHz
$r_{BE}$	(Notes 3, 4)	$10\text{ }\mu\text{A}, < I_C < 2\text{ mA}$ $T_A = 25^\circ\text{C}$		1		V	$\Omega$

8

Parameter	Description	Test Conditions	EP2015AC				Units
			Min	Typ	Max	Test Level	
$\Delta V_{BE}$	(Note 1)	$V_{CE} = 4V, I_C = 1\text{ mA}$ $T_A = 25^\circ\text{C}$			1	I	mV
		$T_{MIN} < T_A < T_{MAX}$			2	III	mV
$\Delta H_{fe1}$	(Notes 1, 2)	$V_{CE} = 1V, I_C = 0.1\text{ mA}$ $T_A = 25^\circ\text{C}$			5	I	%
		$T_{MIN} < T_A < T_{MAX}$			10	III	%
$\Delta H_{fe2}$	(Notes 1, 2)	$V_{CE} = 1V, I_C = 1\text{ mA}$ $T_A = 25^\circ\text{C}$			5	I	%
		$T_{MIN} < T_A < T_{MAX}$			10	III	%
$\Delta H_{fe3}$	(Notes 1, 2)	$V_{CE} = 1V, I_C = 10\text{ mA}$ $T_A = 25^\circ\text{C}$			5	I	%
		$T_{MIN} < T_A < T_{MAX}$			10	III	%

# EP2015C/EP2015AC

## Fast Quad PNP Array

### Electrical Characteristics — Contd.

Parameter	Description	Test Conditions	EP2015A				Units
			Min	Typ	Max	Test Level	
$H_{fe1}$	(Note 3)	$V_{CE} = 1V, I_C = 0.1 \text{ mA}$ $T_A = 25^\circ\text{C}$	150			I	
		$T_{MIN} < T_A < T_{MAX}$	60			III	
$H_{fe2}$	(Note 3)	$V_{CE} = 1V, I_C = 1.0 \text{ mA}$ $T_A = 25^\circ\text{C}$	150			I	
		$T_{MIN} < T_A < T_{MAX}$	60			III	
$H_{fe3}$	(Note 3)	$V_{CE} = 1V, I_C = 10 \text{ mA}$ $T_A = 25^\circ\text{C}$	100			I	
		$T_{MIN} < T_A < T_{MAX}$	40			III	
$V_{BEsat}$	(Note 3)	$I_C = 10 \text{ mA}, I_B = 1 \text{ mA}$ $T_A = 25^\circ\text{C}$			0.90	I	V
		$T_{MIN} < T_A < T_{MAX}$			1.10	III	V
$V_{CEsat}$	(Note 3)	$I_C = 10 \text{ mA}, I_B = 1 \text{ mA}$ $T_A = 25^\circ\text{C}$			0.20	I	V
		$T_{MIN} < T_A < T_{MAX}$			0.30	III	V
$BV_{ceo}$	(Note 3)	$I_C = 1 \text{ mA}, I_B = 0 \text{ mA}$ $T_A = 25^\circ\text{C}$	40			I	V
		$T_{MIN} < T_A < T_{MAX}$	40			I	V
$BV_{cbo}$	(Note 3)	$I_C = 10 \mu\text{A}, I_B = 0 \text{ mA}$ $T_A = 25^\circ\text{C}$	40			I	V
		$T_{MIN} < T_A < T_{MAX}$	40			III	V
$BV_{ebo}$	(Note 3)	$I_B = 10 \mu\text{A}, I_C = 0 \text{ mA}$ $T_A = 25^\circ\text{C}$	5			I	V
		$T_{MIN} < T_A < T_{MAX}$	5			III	V
$I_{cbo}$	(Note 3)	$V_{CB} = 30V, I_E = 0 \text{ mA}$ $T_A = 25^\circ\text{C}$			50	II	nA
		$T_{MIN} < T_A < T_{MAX}$			50	III	nA
$I_{ebo}$	(Note 3)	$V_{CE} = 4V, I_C = 0 \text{ mA}$ $T_A = 25^\circ\text{C}$			50	I	nA
		$T_{MIN} < T_A < T_{MAX}$			50	III	nA
$f_t$	(Note 3)	$V_{CE} = 20V, I_C = 10 \text{ mA}$ $T_A = 25^\circ\text{C}$		350		V	MHz
$r_{BE}$	(Notes 3, 4)	$10 \mu\text{A} < I_C < 2 \text{ mA}$ $T_A = 25^\circ\text{C}$		1		V	$\Omega$

Note 1:  $\Delta V_{BE}$  and  $\Delta H_{fe}$  are measured between each of six possible pairs of transistors.

Note 2:  $\Delta H_{fe}$  is calculated based on the difference divided by the larger of the two readings.

Note 3: Applies to all four transistors.

Note 4: Estimated from log conformity.

# EP2015C/EP2015AC

## Fast Quad PNP Array

EP2015C/EP2015AC

### Typical Performance Curves

20-Lead SOL  
Maximum Power Dissipation  
vs Ambient Temperature

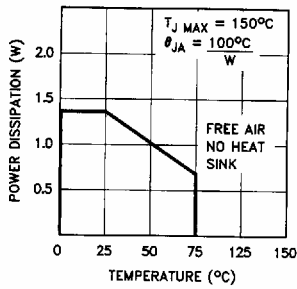

14-Lead Plastic DIP  
Maximum Power Dissipation  
vs Ambient Temperature

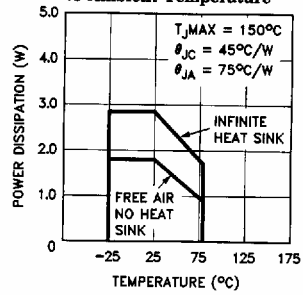

Current Noise

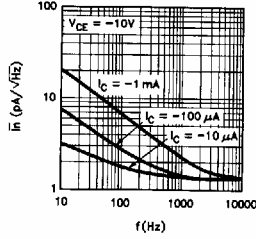

2015-14

Voltage Noise

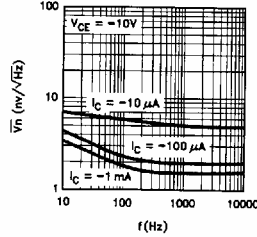

2015-12

C<sub>BE</sub>, C<sub>CSUB</sub>, C<sub>CB</sub> vs Voltage

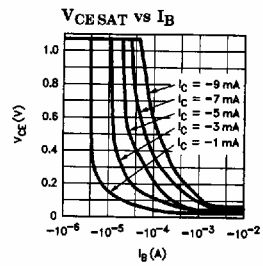
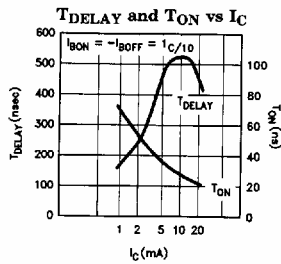
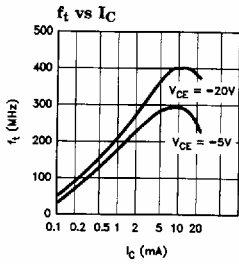
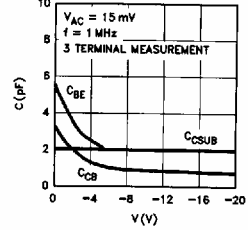

2015-4

# EP2015C/EP2015AC

## Fast Quad PNP Array

### Typical Performance Curves — Contd.

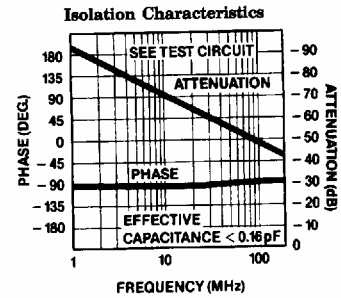
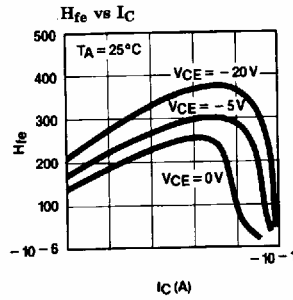
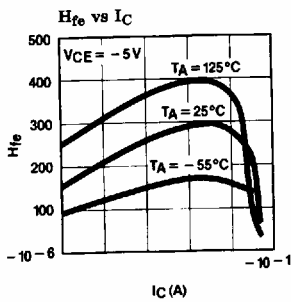
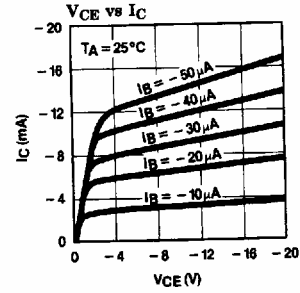
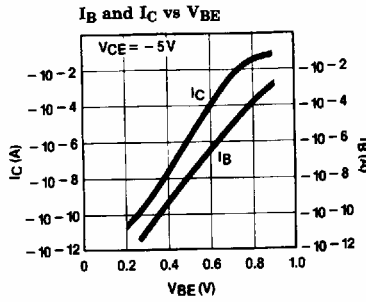
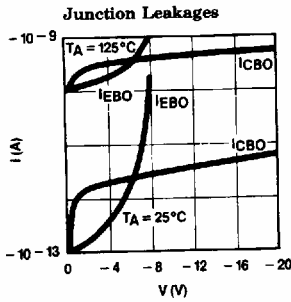

2015-5

#### EP2015 PSPICE® Model

IS =  $8\text{E}-15$  BF = 300 VA = 47 IK = 0.03  
 XTB = 1.3 BR = 4.5 TF = 0.3N TR = 280N  
 RB = 230 RC = 170 ISE =  $1\text{E}-15$  NE = 1.24  
 CCS = 2P MS = 0 CJC = 3.7P PC = 0.5 MC = 0.45  
 CJE = 5.4P PE = 0.6 ME = 0.33 PTF = 15

Note that for the above model the maximum "soft" saturation collector RC is used. For "hard" saturation modeling set  $RC \approx 9$ .  
 PSPICE® is a registered trademark of MicroSim Corporation.

Matched NPN transistors have allowed system designers to make NPN current sinks. Now for the first time Elantec's fast matched PNP transistors are available. These make excellent, fast, matched current sources. The advantages of using current sources as active loads, instead of pullup resistors include:

- Faster, linear pull up (Not exponential)
- High output resistance (This increases voltage gain in many applications)

### Current Sources and Current Mirrors

Current sinks and current mirrors have long been a tool available to the designer of monolithic ICs.

The Norton and Thevenin equivalent circuits of a current source are:

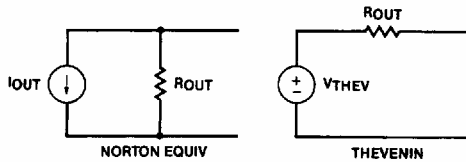

$$\text{And } V_{THEV} = I_{OUT} \times R_{OUT}$$

Four examples of current mirrors are shown, along with some of the advantages and limitations of each topology. For a more thorough discussion see "Analysis and Design of Analog Integrated Circuits" by Grey & Meyer (Wiley 1984), pages 233-247.

All current sources are only as good as the transistors that make them. If the transistors'  $V_{BE}$  match is 5 mV the output current would have a 20% error.

All current sources shown can be improved by putting a resistor in series with the topmost emitters. A 250 mV drop across these resistors reduces a 5 mV  $V_{BE}$  mismatch to a 2% current error. This has the added benefit of increasing output resistance. Elantec can guarantee a 1 mV  $V_{BE}$  match so resistors may not be necessary.

#### Basic Current Source

The Basic Current Mirror is simple and works well at low currents. Its limitations are low output resistance and it is not as fast as the Wilson.

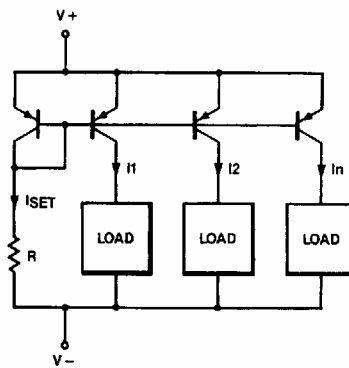

2015-7

$$I_{SET} \approx \frac{((V+) - (V-) - V_{BE})}{R}$$

$$I_1 = I_2 = I_n = \frac{\beta I_1}{\beta + n + 1}$$

$$R_{OUT} = \frac{V_A}{I_{OUT}} = \frac{\text{EARLY VOLTAGE}}{I_{OUT}} = r_o$$

#### PNP Wilson Current Mirror

The Wilson is the best Current Mirror for high frequency applications, and it has plenty of output resistance.

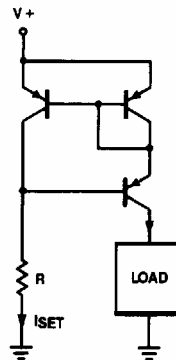

$$I_{OUT} = I_{REF} \left( 1 - \frac{2}{\beta^2 + 2\beta + 2} \right)$$

$$R_{OUT} \approx \frac{\beta r_o}{2}$$

$$V_{THEV} \approx \frac{\beta V_A}{2}$$

2015-9

# EP2015C/EP2015AC

## Fast Quad PNP Array

### Precision Current Source

The Precision Current Source has excellent current match since the error reduction is proportional to  $\beta^2$ . It is slow to turn off since it has no base turn off current. The turn off speed can be increased by using  $R_X$ , at the expense of reduced accuracy.

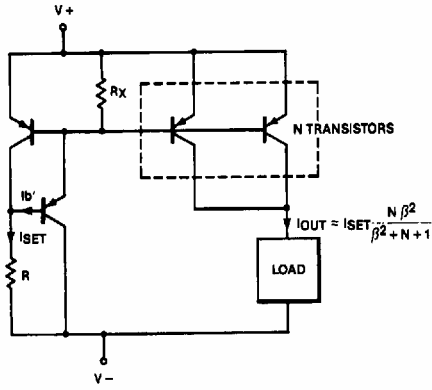

$$I_{SET} \approx \frac{((V+) - (V-)) - 2(V_{BE})}{R}$$

$$I_{OUT} \approx I_{SET} \frac{N \beta^2}{\beta^2 + N + 1}$$

$$R_{OUT} = \frac{V_A}{I_{OUT}}$$

2015-9

### Cascode Current Source

The Cascode Current Source is a basic current mirror with a common base transistor in the collector. This makes  $V_{CE}$  relatively constant for the mirror transistors and greatly increases the output resistance. This has good high frequency characteristics. Note that Q4 and Q5 can be in a package separate from Q1, Q2 and Q3.

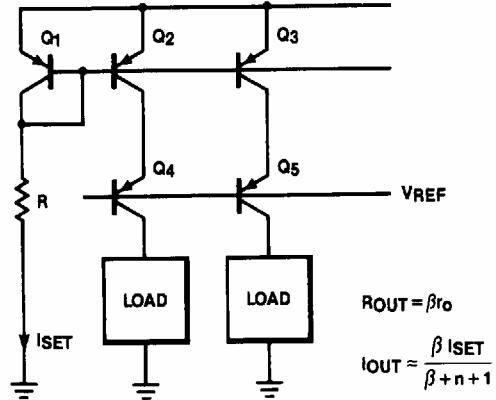

$$R_{OUT} = \beta r_o$$

$$I_{OUT} \approx \frac{\beta I_{SET}}{\beta + n + 1}$$

2015-10





This datasheet has been downloaded from:

[www.DatasheetCatalog.com](http://www.DatasheetCatalog.com)

Datasheets for electronic components.



LittleDiode supplies new, hard to find or obsolete electronic components and semiconductors all over the world.

With over two million different components listed you are sure to find the part you need.

Feel free to visit us today at our online store:

[LittleDiode.com](http://LittleDiode.com)

Looking forward to providing you with the best possible service.