

FDZ204P

P-Channel 2.5V Specified PowerTrench® BGA MOSFET

General Description

Combining Fairchild's advanced 2.5V specified PowerTrench process with state of the art BGA packaging, the FDZ204P minimizes both PCB space and $R_{DS(ON)}$. This BGA MOSFET embodies a breakthrough in packaging technology which enables the device to combine excellent thermal transfer characteristics, high current handling capability, ultra-low profile packaging, low gate charge, and low $R_{DS(ON)}$.

Applications

- Battery management
- Load switch
- Battery protection

Features

- -4.5 A, -20 V. $R_{DS(ON)} = 45 \text{ m}\Omega @ V_{GS} = -4.5 \text{ V}$
 $R_{DS(ON)} = 75 \text{ m}\Omega @ V_{GS} = -2.5 \text{ V}$
- Occupies only 3.7 mm² of PCB area. Less than 40% of the area of a SSOT-6
- Ultra-thin package: less than 0.70 mm height when mounted to PCB
- Ultra-low $Q_g \times R_{DS(ON)}$ figure-of-merit.
- High power and current handling capability.

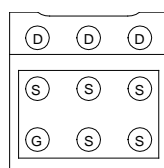

Bottom

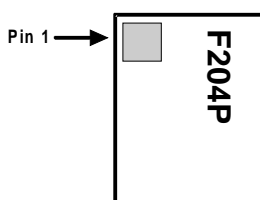

Top

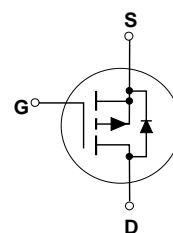

Absolute Maximum Ratings T_A=25°C unless otherwise noted

Symbol	Parameter	Ratings	Units
V _{DSS}	Drain-Source Voltage	-20	V
V _{GSS}	Gate-Source Voltage	±12	V
I _D	Drain Current – Continuous (Note 1a)	-4.5	A
	– Pulsed	-20	
P _D	Power Dissipation (Steady State) (Note 1a)	1.8	W
T _J , T _{STG}	Operating and Storage Junction Temperature Range	-55 to +150	°C

Thermal Characteristics

R _{θJA}	Thermal Resistance, Junction-to-Ambient (Note 1a)	67	°C/W
R _{θJB}	Thermal Resistance, Junction-to-Ball (Note 1)	11	°C/W
R _{θJC}	Thermal Resistance, Junction-to-Case (Note 1)	1	°C/W

Package Marking and Ordering Information

Device Marking	Device	Reel Size	Tape width	Quantity
204P	FDZ204P	7"	8mm	3000 units

Electrical Characteristics

$T_A = 25^\circ\text{C}$ unless otherwise noted

Symbol	Parameter	Test Conditions	Min	Typ	Max	Units
--------	-----------	-----------------	-----	-----	-----	-------

Off Characteristics

BV_{DSS}	Drain–Source Breakdown Voltage	$V_{GS} = 0\text{ V}, I_D = -250\ \mu\text{A}$	-20			V
$\frac{\Delta BV_{DSS}}{\Delta T_J}$	Breakdown Voltage Temperature Coefficient	$I_D = -250\ \mu\text{A}$, Referenced to 25°C		-17		mV/ $^\circ\text{C}$
I_{DSS}	Zero Gate Voltage Drain Current	$V_{DS} = -16\text{ V}, V_{GS} = 0\text{ V}$			-1	μA
I_{GSSF}	Gate–Body Leakage, Forward	$V_{GS} = -12\text{ V}, V_{DS} = 0\text{ V}$			-100	nA
I_{GSSR}	Gate–Body Leakage, Reverse	$V_{GS} = 12\text{ V}, V_{DS} = 0\text{ V}$			100	nA

On Characteristics (Note 2)

$V_{GS(th)}$	Gate Threshold Voltage	$V_{DS} = V_{GS}, I_D = -250\ \mu\text{A}$	-0.6	-0.9	-1.5	V
$\frac{\Delta V_{GS(th)}}{\Delta T_J}$	Gate Threshold Voltage Temperature Coefficient	$I_D = -250\ \mu\text{A}$, Referenced to 25°C		3		mV/ $^\circ\text{C}$
$R_{DS(on)}$	Static Drain–Source On–Resistance	$V_{GS} = -4.5\text{ V}, I_D = -4.5\text{ A}$ $V_{GS} = -2.5\text{ V}, I_D = -3.5\text{ A}$ $V_{GS} = -4.5\text{ V}, I_D = -4.5\text{ A}, T_J = 125^\circ\text{C}$		37 57 50	45 75 65	m Ω
$I_{D(on)}$	On–State Drain Current	$V_{GS} = -4.5\text{ V}, V_{DS} = -5.0\text{ V}$	-20			A
g_{FS}	Forward Transconductance	$V_{DS} = -5\text{ V}, I_D = -4.5\text{ A}$		15		S

Dynamic Characteristics

C_{iss}	Input Capacitance	$V_{DS} = -10\text{ V}, V_{GS} = 0\text{ V}$		884		pF
C_{oss}	Output Capacitance	$f = 1.0\text{ MHz}$		258		pF
C_{riss}	Reverse Transfer Capacitance			103		pF

Switching Characteristics (Note 2)

$t_{d(on)}$	Turn–On Delay Time	$V_{DD} = -6\text{ V}, I_D = -1\text{ A}$		12	22	ns
t_r	Turn–On Rise Time	$V_{GS} = -4.5\text{ V}, R_{GEN} = 6\ \Omega$		9	18	ns
$t_{d(off)}$	Turn–Off Delay Time			36	58	ns
t_f	Turn–Off Fall Time			24	38	ns
Q_g	Total Gate Charge	$V_{DS} = -10\text{ V}, I_D = -4.5\text{ A}$		9	13	nC
Q_{gs}	Gate–Source Charge	$V_{GS} = -4.5\text{ V}$		2		nC
Q_{gd}	Gate–Drain Charge			3		nC

Drain–Source Diode Characteristics and Maximum Ratings

I_S	Maximum Continuous Drain–Source Diode Forward Current				-1.5	A
V_{SD}	Drain–Source Diode Forward Voltage	$V_{GS} = 0\text{ V}, I_S = -1.5\text{ A}$ (Note 2)		-0.76	-1.2	V
t_{rr}	Diode Reverse Recovery Time	$I_F = -5.5\text{ A}$		25		nS
Q_{rr}	Diode Reverse Recovery Charge	$dI_F/dt = 100\text{ A}/\mu\text{s}$		26		nC

Notes:

- $R_{\theta JA}$ is determined with the device mounted on a 1 in² 2 oz. copper pad on a 1.5 x 1.5 in. board of FR-4 material. The thermal resistance from the junction to the circuit board side of the solder ball, $R_{\theta JB}$, is defined for reference. For $R_{\theta JC}$, the thermal reference point for the case is defined as the top surface of the copper chip carrier. $R_{\theta JC}$ and $R_{\theta JB}$ are guaranteed by design while $R_{\theta JA}$ is determined by the user's board design.



- a) 67 $^\circ\text{C}/\text{W}$ when mounted on a 1in² pad of 2 oz copper, 1.5" x 1.5" x 0.062" thick PCB



- b) 155 $^\circ\text{C}/\text{W}$ when mounted on a minimum pad of 2 oz copper

Scale 1 : 1 on letter size paper

2. Pulse Test: Pulse Width < 300 μs , Duty Cycle < 2.0%

Dimensional Outline and Pad Layout

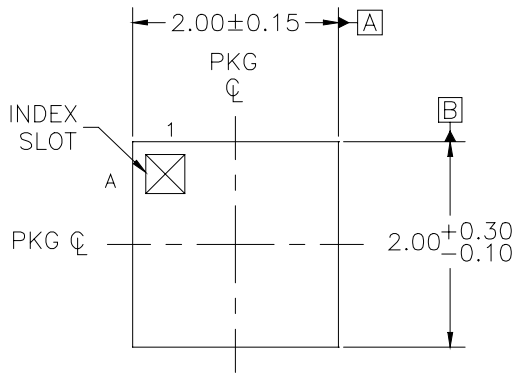

TOP VIEW

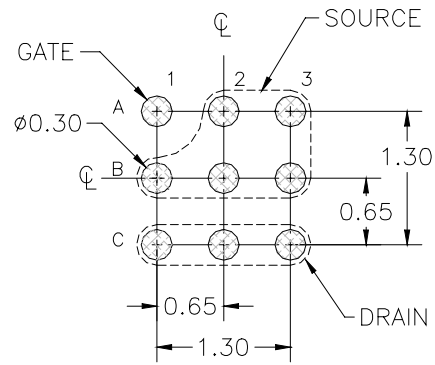

LAND PATTERN RECOMMENDATION

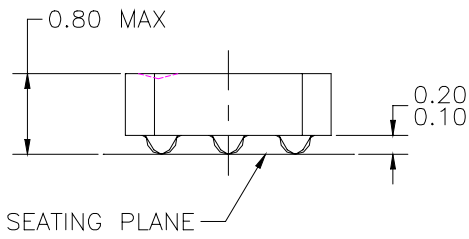

FRONT VIEW

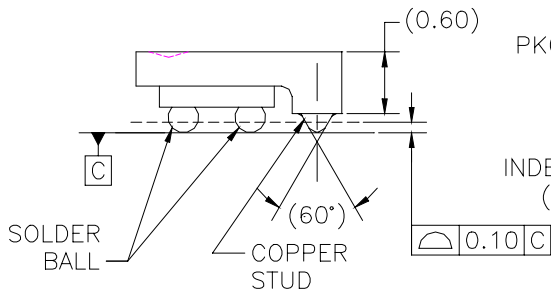

SIDE VIEW

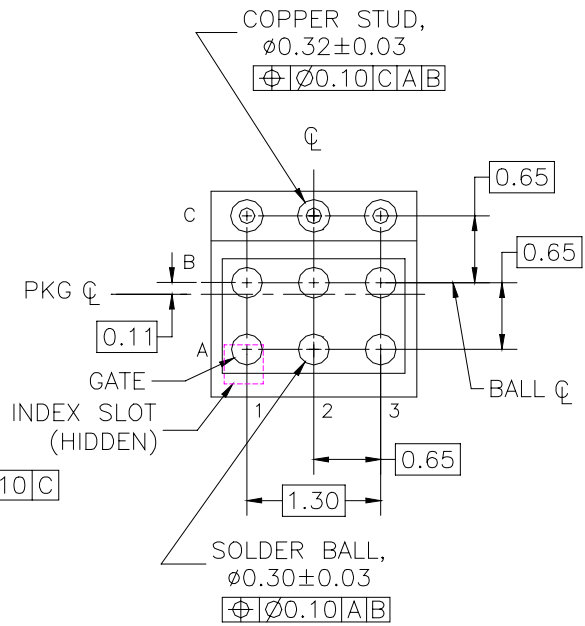

BOTTOM VIEW

NOTES: UNLESS OTHERWISE SPECIFIED

- A) ALL DIMENSIONS ARE IN MILLIMETERS.
- B) NO JEDEC REGISTRATION REFERENCE AS OF JULY 1999.
- C) TERMINAL CONFIGURATION TABLE.

POSITION	DESIGNATION	TYPE
C1,C2,C3	DRAIN	COPPER STUD
A1	GATE	SOLDER BALL
A2,A3,B1,B2,B3	SOURCE	SOLDER BALL

BGA06BREV B

Typical Characteristics

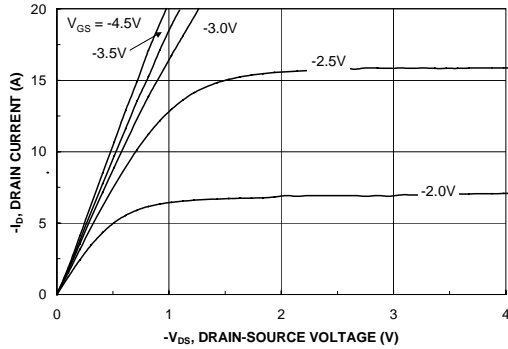

Figure 1. On-Region Characteristics.

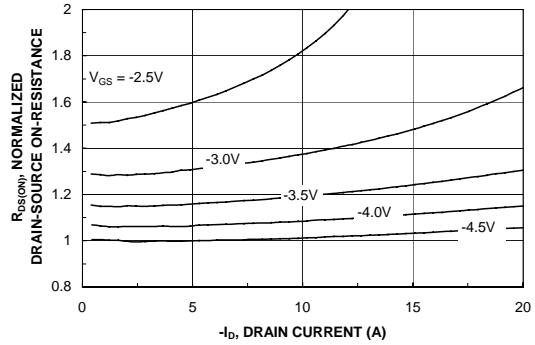

Figure 2. On-Resistance Variation with Drain Current and Gate Voltage.

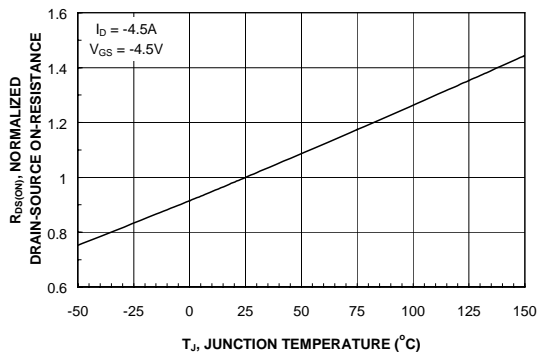

Figure 3. On-Resistance Variation with Temperature.

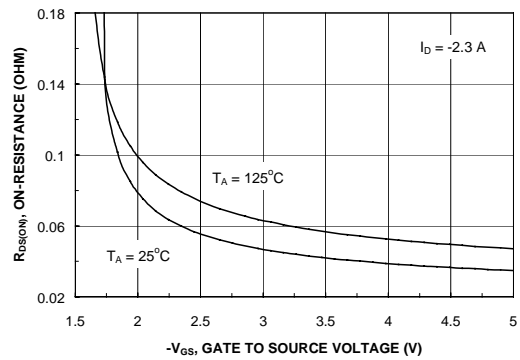

Figure 4. On-Resistance Variation with Gate-to-Source Voltage.

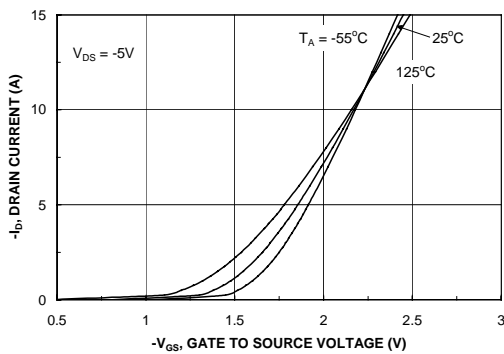

Figure 5. Transfer Characteristics.

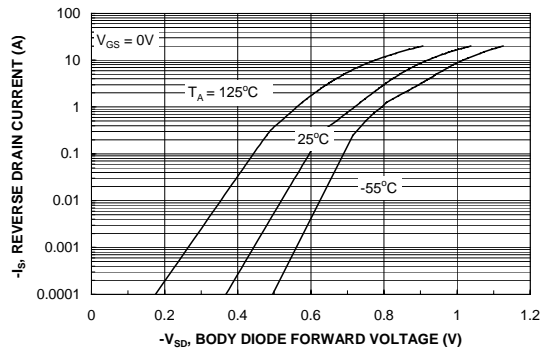

Figure 6. Body Diode Forward Voltage Variation with Source Current and Temperature.

Typical Characteristics

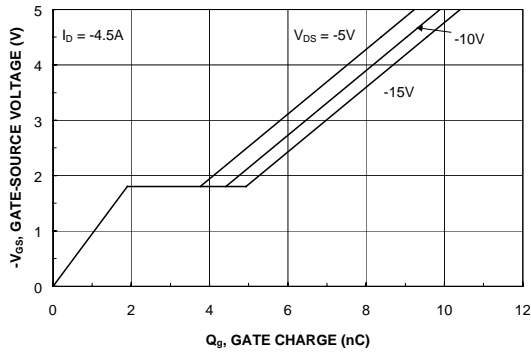

Figure 7. Gate Charge Characteristics.

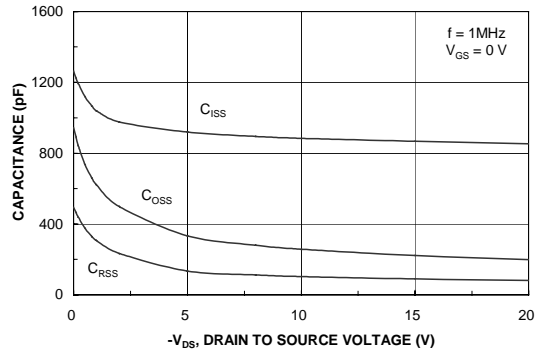

Figure 8. Capacitance Characteristics.

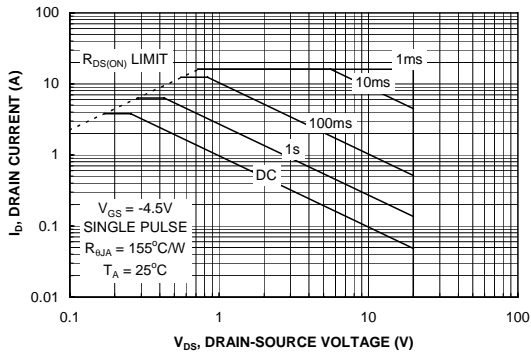

Figure 9. Maximum Safe Operating Area.

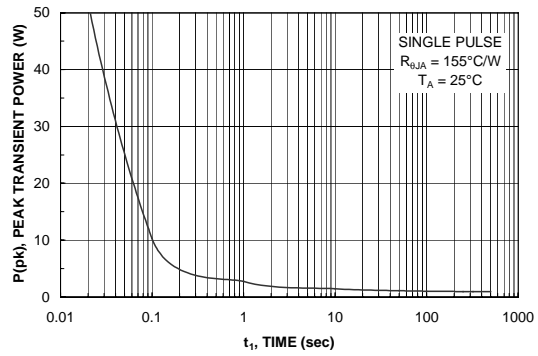

Figure 10. Single Pulse Maximum Power Dissipation.

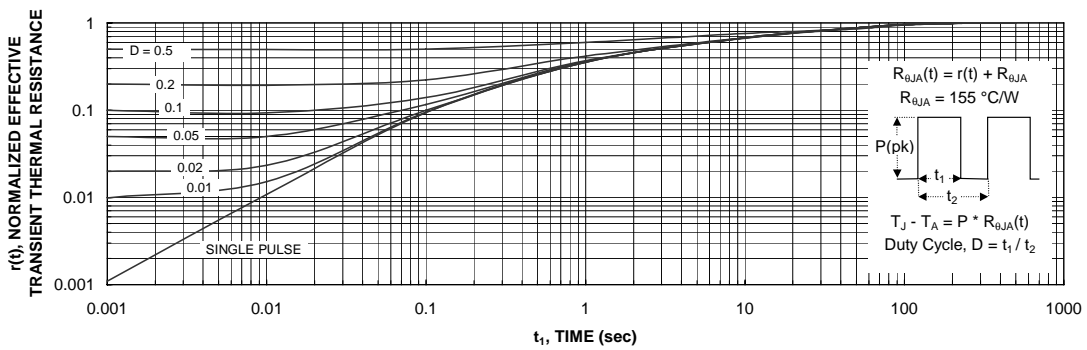

Figure 11. Transient Thermal Response Curve.

Thermal characterization performed using the conditions described in Note 1b.
Transient thermal response will change depending on the circuit board design.

TRADEMARKS

The following are registered and unregistered trademarks Fairchild Semiconductor owns or is authorized to use and is not intended to be an exhaustive list of all such trademarks.

ACE _x [™]	FAST _r [™]	OPTOLOGIC [®]	SMART START [™]	VCX [™]
Bottomless [™]	FRFET [™]	OPTOPLANAR [™]	SPM [™]	
CoolFET [™]	GlobalOptoisolator [™]	PACMAN [™]	Stealth [™]	
CROSSVOLT [™]	GTO [™]	POP [™]	SuperSOT [™] -3	
DOME [™]	HiSeC [™]	Power247 [™]	SuperSOT [™] -6	
EcoSPARK [™]	I ² C [™]	PowerTrench [®]	SuperSOT [™] -8	
E ² CMOS [™]	ISOPLANAR [™]	QFET [™]	SyncFET [™]	
EnSigna [™]	LittleFET [™]	QST [™]	TinyLogic [™]	
FACT [™]	MicroFET [™]	QT Optoelectronics [™]	TruTranslation [™]	
FACT Quiet Series [™]	MicroPak [™]	Quiet Series [™]	UHC [™]	
FAST [®]	MICROWIRE [™]	SILENT SWITCHER [®]	UltraFET [®]	

DISCLAIMER

FAIRCHILD SEMICONDUCTOR RESERVES THE RIGHT TO MAKE CHANGES WITHOUT FURTHER NOTICE TO ANY PRODUCTS HEREIN TO IMPROVE RELIABILITY, FUNCTION OR DESIGN. FAIRCHILD DOES NOT ASSUME ANY LIABILITY ARISING OUT OF THE APPLICATION OR USE OF ANY PRODUCT OR CIRCUIT DESCRIBED HEREIN; NEITHER DOES IT CONVEY ANY LICENSE UNDER ITS PATENT RIGHTS, NOR THE RIGHTS OF OTHERS.

LIFE SUPPORT POLICY

FAIRCHILD'S PRODUCTS ARE NOT AUTHORIZED FOR USE AS CRITICAL COMPONENTS IN LIFE SUPPORT DEVICES OR SYSTEMS WITHOUT THE EXPRESS WRITTEN APPROVAL OF FAIRCHILD SEMICONDUCTOR CORPORATION. As used herein:

1. Life support devices or systems are devices or systems which, (a) are intended for surgical implant into the body, or (b) support or sustain life, or (c) whose failure to perform when properly used in accordance with instructions for use provided in the labeling, can be reasonably expected to result in significant injury to the user.
2. A critical component is any component of a life support device or system whose failure to perform can be reasonably expected to cause the failure of the life support device or system, or to affect its safety or effectiveness.

PRODUCT STATUS DEFINITIONS

Definition of Terms

Datasheet Identification	Product Status	Definition
Advance Information	Formative or In Design	This datasheet contains the design specifications for product development. Specifications may change in any manner without notice.
Preliminary	First Production	This datasheet contains preliminary data, and supplementary data will be published at a later date. Fairchild Semiconductor reserves the right to make changes at any time without notice in order to improve design.
No Identification Needed	Full Production	This datasheet contains final specifications. Fairchild Semiconductor reserves the right to make changes at any time without notice in order to improve design.
Obsolete	Not In Production	This datasheet contains specifications on a product that has been discontinued by Fairchild semiconductor. The datasheet is printed for reference information only.



LittleDiode supplies new, hard to find or obsolete electronic components and semiconductors all over the world.

With over two million different components listed you are sure to find the part you need.

Feel free to visit us today at our online store:

LittleDiode.com

Looking forward to providing you with the best possible service.