

FS10KM-5

HIGH-SPEED SWITCHING USE

FS10KM-5

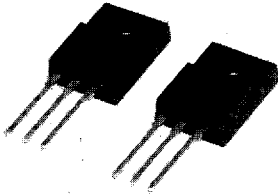

- V_{DSS} 250V
- r_{DS (ON)} (MAX) 0.52Ω
- I_D 10A
- V_{iso} 2000V

OUTLINE DRAWING

Dimensions in mm

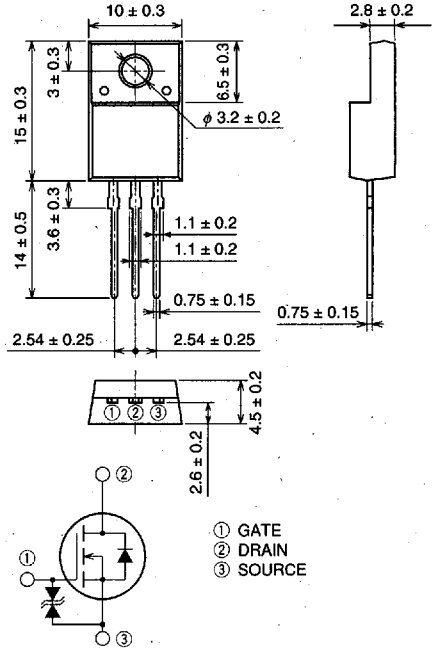

TO-220FN

APPLICATION

SMPS, DC-DC Converter, battery charger, power supply of printer, copier, HDD, FDD, TV, VCR, personal computer etc.

MAXIMUM RATINGS (T_c = 25°C)

Symbol	Parameter	Conditions	Ratings	Unit
V _{DSS}	Drain-source voltage	V _{GS} = 0V	250	V
V _{GSS}	Gate-source voltage	V _{DS} = 0V	±30	V
I _D	Drain current		10	A
I _{DM}	Drain current (Pulsed)		30	A
P _D	Maximum power dissipation		35	W
T _{ch}	Channel temperature		-55 ~ +150	°C
T _{stg}	Storage temperature		-55 ~ +150	°C
V _{iso}	Isolation voltage	AC for 1minute, Terminal to case	2000	V _{rms}
—	Weight	Typical value	2.0	g

6249829 0019641 5T6

ELECTRICAL CHARACTERISTICS (Tch = 25°C)

Symbol	Parameter	Test conditions	Limits			Unit
			Min.	Typ.	Max.	
V (BR) DSS	Drain-source breakdown voltage	ID = 1mA, VGS = 0V	250	—	—	V
V (BR) GSS	Gate-source breakdown voltage	IG = ±100μA, VDS = 0V	±30	—	—	V
IGSS	Gate leakage current	VGS = ±25V, VDS = 0V	—	—	±10	μA
IDSS	Drain current	VDS = 250V, VGS = 0V	—	—	1	mA
VGS (th)	Gate-source threshold voltage	ID = 1mA, VDS = 10V	2	3	4	V
rDS (ON)	Drain-source on-state resistance	ID = 5A, VGS = 10V	—	0.40	0.52	Ω
VDS (ON)	Drain-source on-state voltage	ID = 5A, VGS = 10V	—	2.0	2.6	V
yfs	Forward transfer admittance	ID = 5A, VDS = 10V	4.0	6.0	—	S
Ciss	Input capacitance	VDS = 25V, VGS = 0V, f = 1MHz	—	570	—	pF
Coss	Output capacitance		—	110	—	pF
Crss	Reverse transfer capacitance		—	20	—	pF
td (on)	Turn-on delay time	VDD = 150V, ID = 5A, VGS = 10V, RGEN = RGS = 50Ω	—	17	—	ns
tr	Rise time		—	25	—	ns
td (off)	Turn-off delay time		—	60	—	ns
tf	Fall time		—	30	—	ns
VSD	Source-drain voltage	IS = 5A, VGS = 0V	—	1.5	2.0	V
Rth (ch-c)	Thermal resistance	Channel to case	—	—	3.57	°C/W

PERFORMANCE CURVES

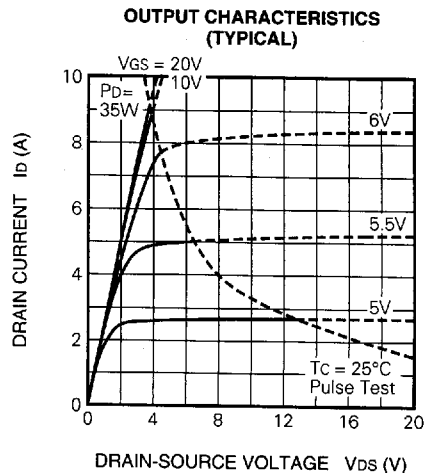
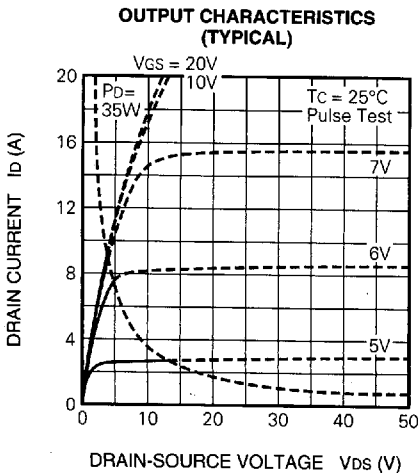
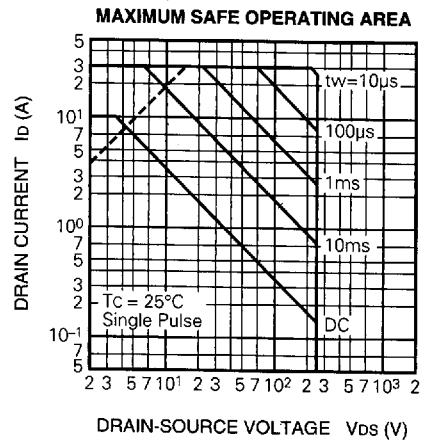
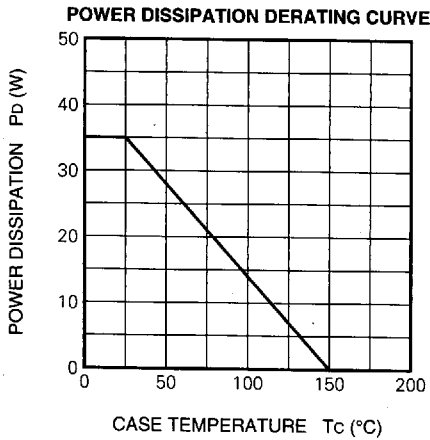

ON-STATE VOLTAGE VS. GATE-SOURCE VOLTAGE (TYPICAL)

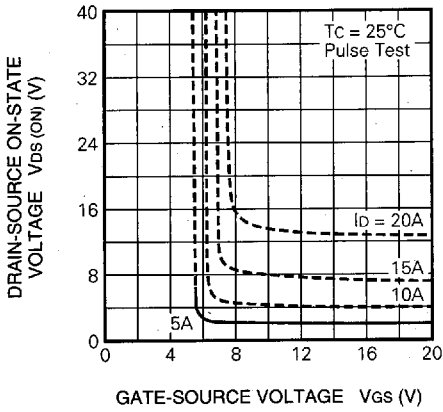

ON-STATE RESISTANCE VS. DRAIN CURRENT (TYPICAL)

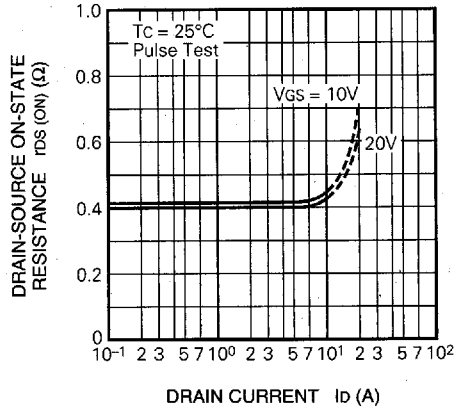

TRANSFER CHARACTERISTICS (TYPICAL)

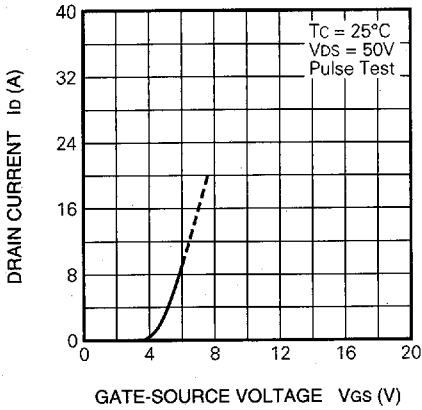

FORWARD TRANSFER ADMITTANCE VS. DRAIN CURRENT (TYPICAL)

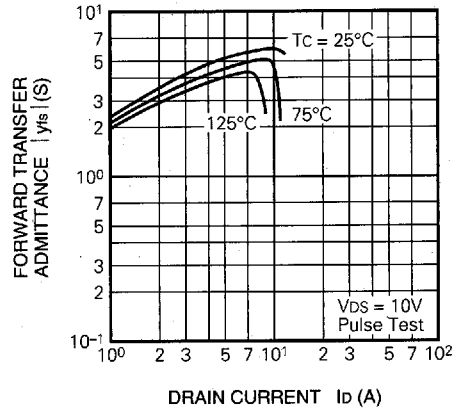

CAPACITANCE VS. DRAIN-SOURCE VOLTAGE (TYPICAL)

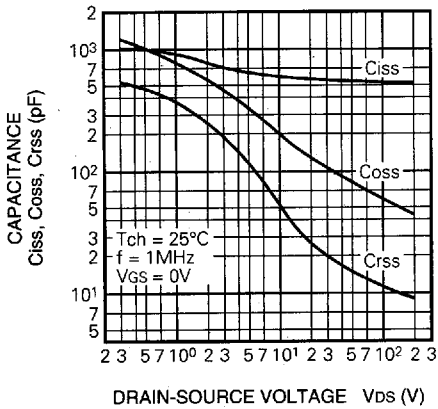

SWITCHING CHARACTERISTICS (TYPICAL)

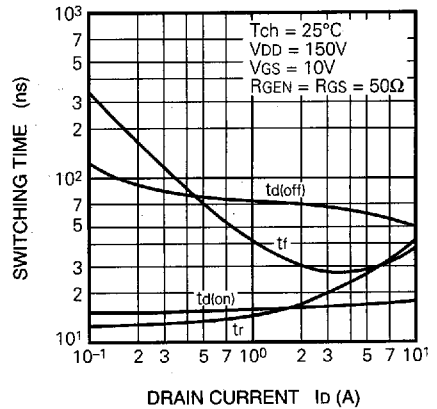

GATE-SOURCE VOLTAGE VS. GATE CHARGE (TYPICAL)

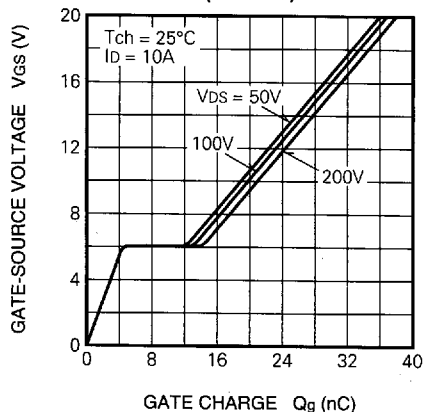

SOURCE-DRAIN DIODE FORWARD CHARACTERISTICS (TYPICAL)

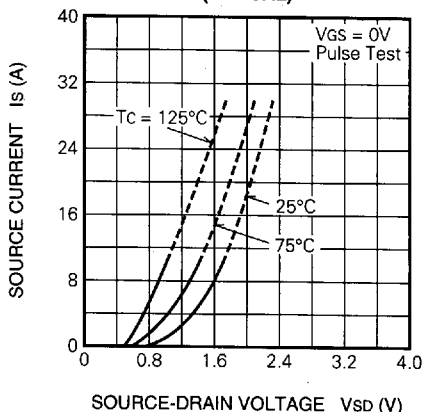

ON-STATE RESISTANCE VS. CHANNEL TEMPERATURE (TYPICAL)

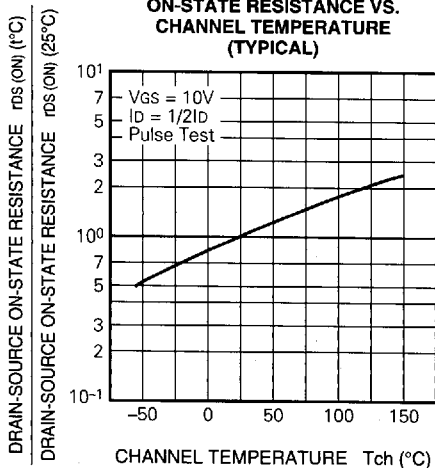

THRESHOLD VOLTAGE VS. CHANNEL TEMPERATURE (TYPICAL)

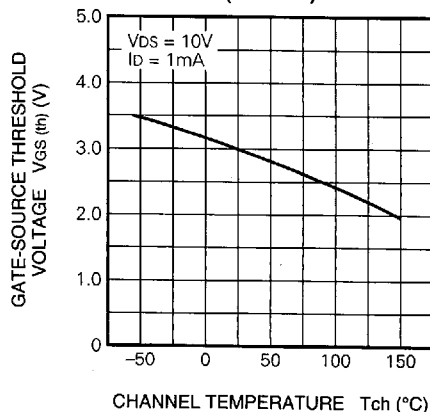

BREAKDOWN VOLTAGE VS. CHANNEL TEMPERATURE (TYPICAL)

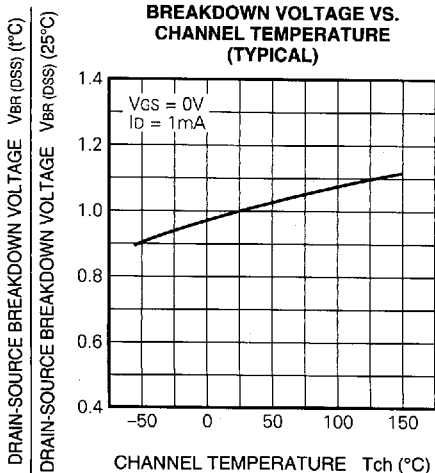

TRANSIENT THERMAL IMPEDANCE CHARACTERISTICS

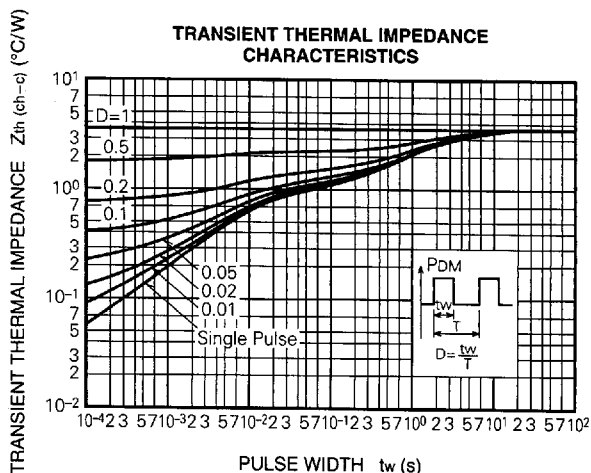

MITSUBISHI POWER MOSFET LEAD FORMING OUTLINE AND TAPING

LEAD FORMING

(1) TO-220 outline

Applicable device FS**UM-***A

Standard outline	Standard forming outline			
	A5	A6	A8	AA
Dimensions $a=3.0\pm 0.5$, $b=14.7\pm 0.5$, $c=5.0\pm 0.5$, $d=4.5\pm 0.5$, $e=20.1\pm 0.5$, $f=3.0\pm 0.5$, $g=15.5\pm 0.5$ $h=16.0\pm 0.5$, $i=5.5\pm 0.5$ ※Dimensions measured during processing				Unit: mm

(1) TO-220 full molded outline

Applicable device FS**KM-***A

Standard outline	Standard forming outline			
	A5	A6	A8	AA
Dimensions $a=3.0\pm 0.5$, $b=14.7\pm 0.5$, $c=5.0\pm 0.5$, $d=4.5\pm 0.5$, $e=20.1\pm 0.5$, $g=15.5\pm 0.5$, $h=16.0\pm 0.5$, $i=5.5\pm 0.5$, $j=19.0\pm 0.5$, $k=7.75\pm 0.5$, $l=4.0\pm 0.5$, $m=15.1\pm 0.5$, $n=16.5\pm 0.5$, $o=3.8\pm 0.35$ ※Dimensions measured during processing				Unit: mm

6249829 0019591 140

MITSUBISHI POWER MOSFET
LEAD FORMING OUTLINE AND TAPING

(2) TO-220 full molded outline

Applicable device FS**KM-***A

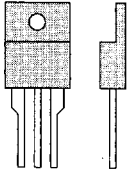
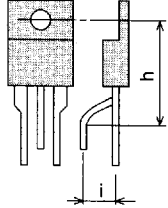
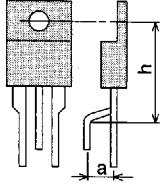
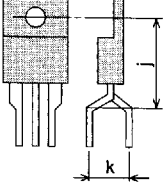
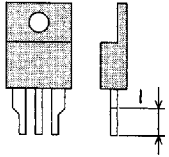
Standard outline	Standard forming outline				
	AT	AU	AV	AW	
					
Dimensions	a=3.0±0.5, b=14.7±0.5, c=5.0±0.5, d=4.5±0.5, e=20.1±0.5, g=15.5±0.5, h=16.0±0.5, i=5.5±0.5, j=19.0±0.5, k=7.75±0.5, l=4.0±0.5, m=15.1±0.5, n=16.5±0.5, o=3.8±0.35 ※Dimensions measured during processing				Unit : mm

(3) TO-3P outline

Applicable device FS**SM-***A · CT**SM-***

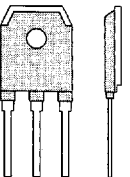
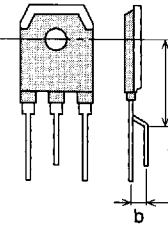
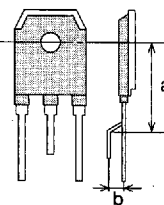
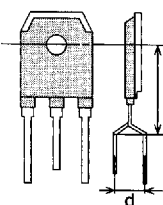
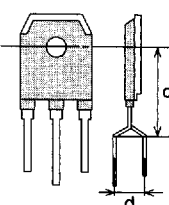
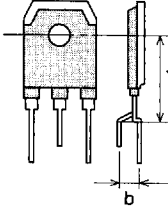
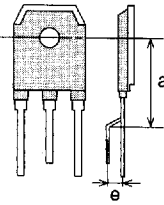
Standard outline	Standard forming outline				
	A7	A8	A9	A8	
					
					
Dimensions	a=23.5, b=5.45, c=23, d=9.5, e=4, f=21.5 ※Dimensions measured during processing				Unit : mm

MITSUBISHI POWER MOSFET

LEAD FORMING OUTLINE AND TAPING

(4) TO-3PL outline

Applicable device	CT**AM-***
-------------------	------------

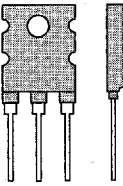
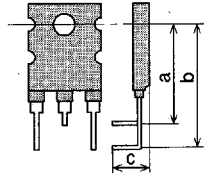
Standard outline	Standard forming outline AC		
		Dimensions	$a=24\pm 0.5$ $b=31.5\pm 0.5$ $c=13.3\pm 0.6$ ※Dimensions measured during processing
			Unit : mm

(5) MP-3 outline

Applicable device	FS**AS-**A · CT20A**-8
-------------------	------------------------

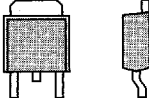
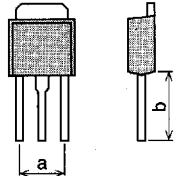
Standard outline	Standard forming outline A1		
		Dimensions	$a=4.6$ $b=14\text{min.}$ ※Dimensions measured during processing
			Unit : mm

LEAD FORMING OUTLINE AND TAPING

TAPING

(1) TO-220S

(a) Marking

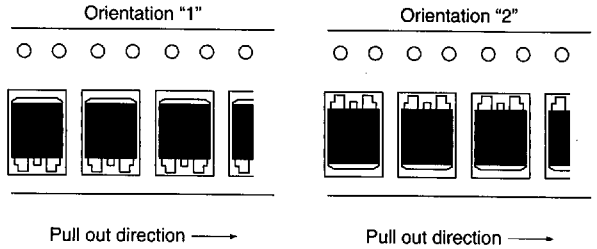
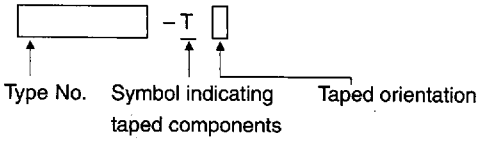

(b) Taping

- Tape shape and dimensions

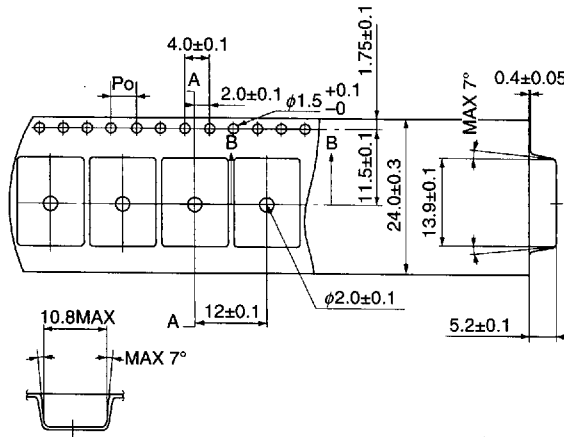

Notice : The cumulative pitch error of P_0 (Free hole pitch) is $\pm 0.2\text{mm}$ per 10 pitches.

- Reel shape and dimensions

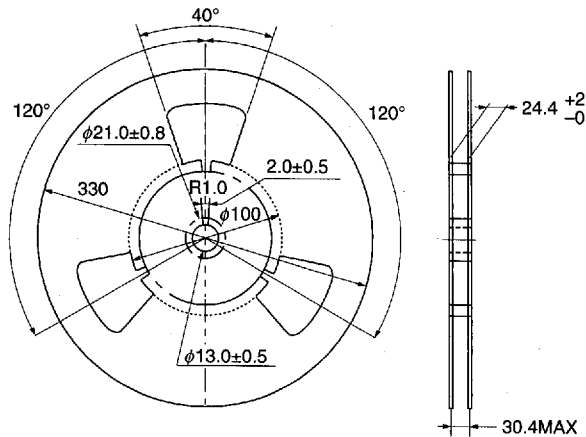

LEAD FORMING OUTLINE AND TAPING

(2) MP-3

(a) Marking

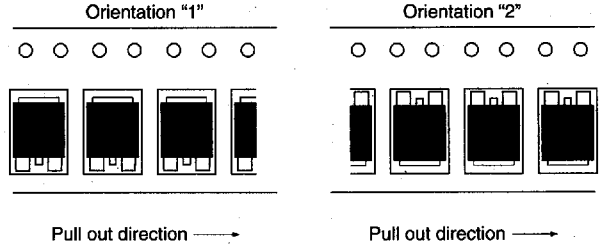
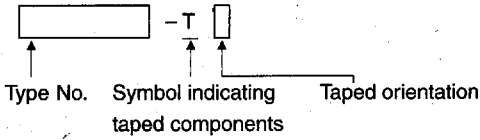

(b) Taping

- Tape shape and dimensions

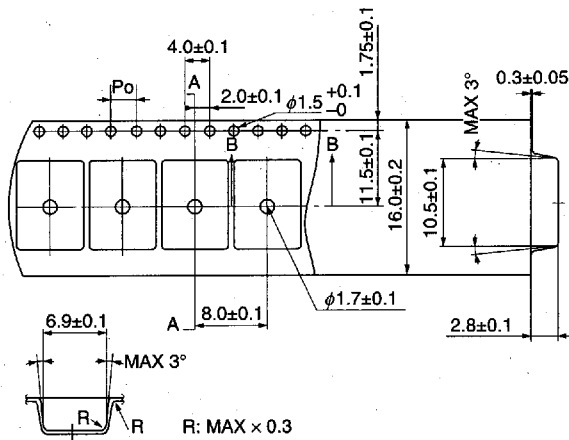

Notice : The cumulative pitch error of Po (Free hole pitch) is $\pm 0.2\text{mm}$ per 10 pitches.

- Reel shape and dimensions

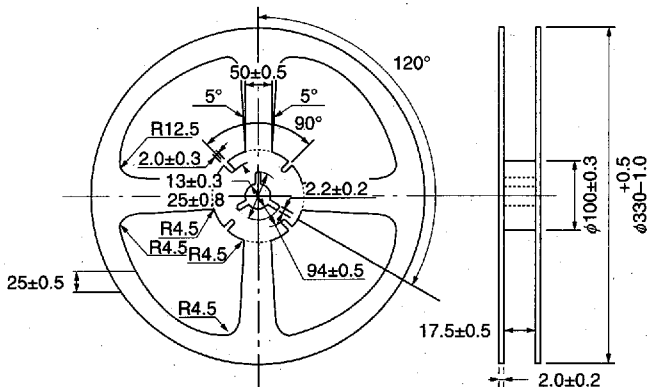

LEAD FORMING OUTLINE AND TAPING

Recommended conditions for surface mounting type

Outline : TO-220S, MP-3

- (1) Board : Alumina, Insulated metal board
- (2) Solder plate thickness : 150 μ m-250 μ m
- (3) Temperature profile

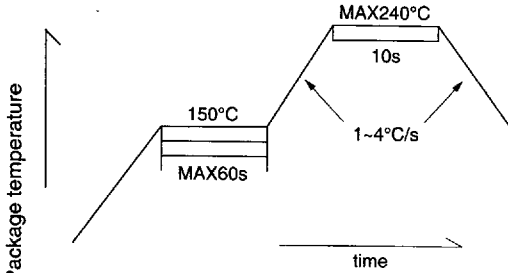

Infrared rays reflow temperature profile

Individual package for lead forming outline

- (1) TO-220, TO-220FN, TO-220C, TO-220S

Dimensions in (Unit : mm)

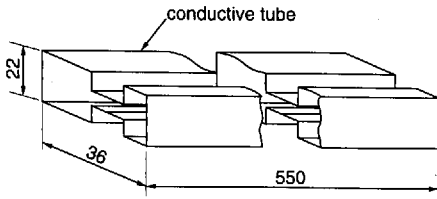

The capacity is 50 p.c.s. (max.)

- (2) TO-3P

Dimensions in (Unit : mm)

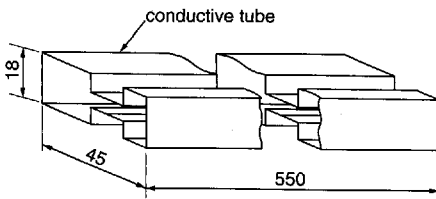

The capacity is 30 p.c.s. (max.)