

HA13127, HA13130

17 W Dual BTL Audio Power Amplifier

The HA13127/HA13130 are high output and low distortion dual BTL power IC designed for car stereo amplifiers.

At 14.4 V to 4 Ω load, this power IC provides an output power 17 W with 10 % distortion.

Features

- Stand-by circuit included.
Can be switched on & off easily by microcomputer.
- Output capacitors not required.
These IC employ internal ASO protection circuit of high reliability current shutdown type, which can protect speaker.
- Surge protection circuit and thermal shutdown circuit are included.
Thermal shutdown is high speed and hysteresis on & off type.
- Can be used without bootstrap capacitor.
- Low total harmonic distortion in wide frequency range
THD = 0.05 % Typ ($f = 50$ Hz)
THD = 0.05 % Typ ($f = 1$ kHz)
THD = 0.07 % Typ ($f = 10$ kHz)
THD = 0.1 % or less
($P_{out} = 1.5$ W, $f = 20$ Hz to 20 kHz)

Ordering Information

Type No.	Voltage gain	Package
HA13127	50 dB	16 pin SIP with heat sink
HA13130	40 dB	



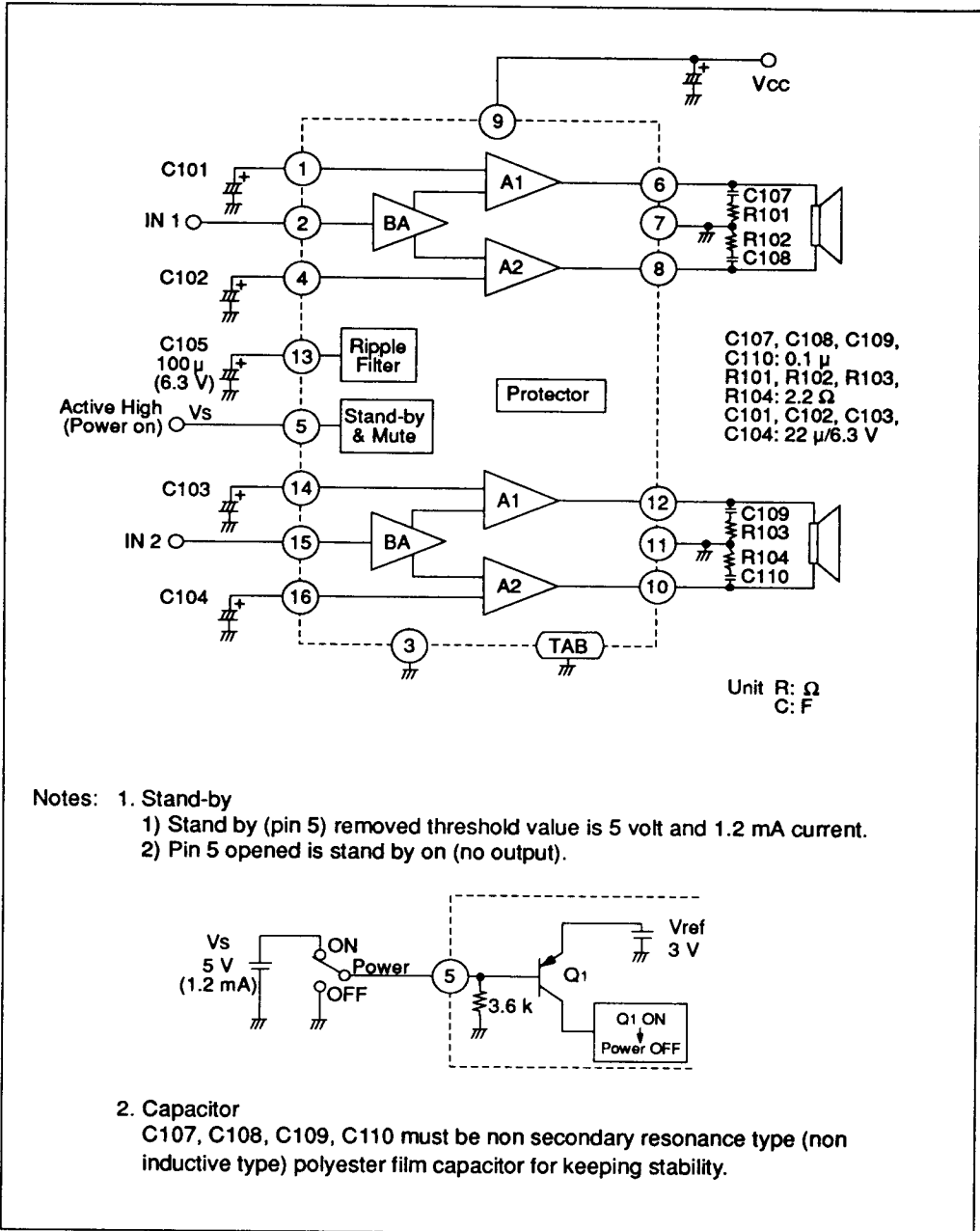

Figure 1 Block Diagram



HA13127, HA13130

Absolute Maximum Ratings (Ta = 25 °C)

Item	Symbol	Rating	Unit	Notes
Operating supply voltage	Vcc	18	V	
DC supply voltage	Vcc (DC)	26	V	1
Peak supply voltage	Vcc (Peak)	50	V	2
Output current	Io (peak)	4	A	Per channel
Power dissipation	Pr	25	W	
Junction temperature	Tj	150	°C	
Operating temperature	Topr	-30 to +85	°C	
Storage temperature	Tstg	-55 to +125	°C	

Notes: 1. Value at $t \leq 30$ sec

2. Value at surge wave-form (rise time $t \geq 1$ ms)

Electrical Characteristics (Vcc = 13.2 V, f = 1 kHz, RL = 4 Ω, dual operation, Ta = 25 °C)

HA13127 (Gv = 50 dB) HA13130 (Gv = 40 dB)

Item	Symbol	HA13127 (Gv = 50 dB)			HA13130 (Gv = 40 dB)			Unit	Test Conditions
		Min	Typ	Max	Min	Typ	Max		
Quiescent current	Iq1	60	150	250	60	150	250	mA	Vin = 0 V
Input bias voltage	Vb	—	20	40	—	20	40	mV	Vin = 0 V
Output offset voltage	ΔVo	—	0	150	—	0	150	mV	Vin = 0 V
Voltage gain	Gv	48.5	50	51.5	38.5	40	41.5	dB	
Difference of voltage gain	ΔGv	—	—	1.5	—	—	1.5	dB	
Output power (1)	Po1	10	14	—	10	14	—	W	Vcc = 13.2 V THD = 10 %
Output power (2)	Po2	—	17	—	—	17	—	W	Vcc = 14.4 V THD = 10 %
Output power (3)	Po3	—	6	—	—	11	—	W	Vcc = 13.2 V THD = 1 %
Total harmonic distortion	THD	—	0.2	0.7	—	0.04	0.15	%	Pout = 1.5 W



Electrical Characteristics ($V_{CC} = 13.2\text{ V}$, $f = 1\text{ kHz}$, $R_L = 4\ \Omega$, dual operation, $T_a = 25\ ^\circ\text{C}$) (cont)

Noise output (1)	WBN ₁	—	1.0	2.0	—	0.35	0.7	mV	$R_g = 10\text{ k}\Omega$ BW = 20 Hz to 20 kHz
Noise output (2)	WBN ₂	—	0.8	1.7	—	0.25	0.5	mV	$R_g = 0$ BW = 20 Hz to 20 kHz
Supply voltage rejection ratio	SVR	32	40	—	45	60	—	dB	$f = 500\text{ Hz}$, Vripple = 0 dBm
Low roll-off Frequency	$f_{L\alpha}$	—	20	—	—	10	—	Hz	$\Delta G_v = -3\text{ dB}$ from
High roll-off frequency	$f_{H\alpha}$	—	20	—	30	70	140	kHz	$f = 1\text{ kHz}$
Stand-by current	I_{OZ}	—	50	200	—	50	200	μA	V 5 Open
Stand-by threshold voltage	$V_{TH(H)}$	5	—	$V_{CC}-1$	5	—	$V_{CC}-1$	V	$V_{in} = 50\text{ dBm}$ Output on
	$V_{TH(L)}$	0	—	1	0	—	1	V	Output off
Stand-by (Mute) signal reduction level	ATT	45	60	—	45	60	—	dB	$V_{in} = -50\text{ dBm}$
Stand-by (Mute) on time	t_F	—	10	—	—	10	—	μs	$V_1 = 3\text{ V}$ to Open (Power on to off)
Stand-by (Mute) off time	t_R	—	0.2	—	—	0.2	—	sec	$V_1 = \text{Open}$ to 3 V (Power off to on)
Input impedance	R_{in}	20	30	40	20	30	40	$\text{k}\Omega$	
Channel cross-talk	CT	—	60	—	45	60	—	dB	$V_{out} = 0\text{ dBm}$
Output power (4)	P_{O4}	—	10	—	—	10	—	W	THD = 10 % $R_L = 8\ \Omega$
Output power (5)	P_{O5}	—	7	—	—	7	—	W	THD = 1 % $R_L = 8\ \Omega$



Output power vs. supply voltage (1)

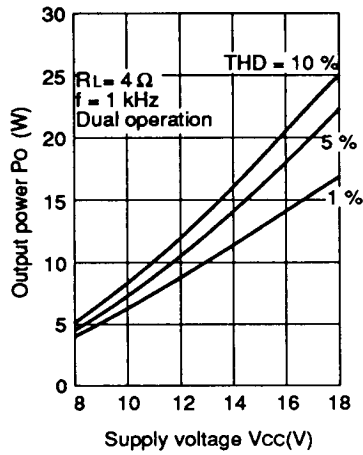

Output power vs. supply voltage (2)

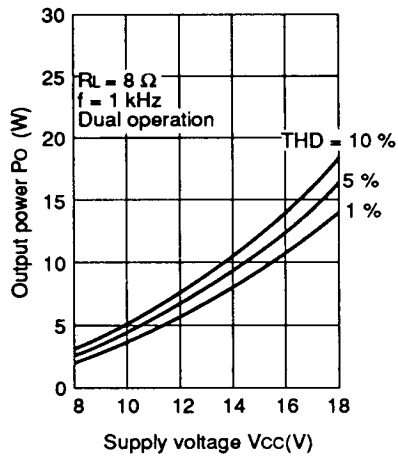

Figure 2 HA13130 Characteristic Curves



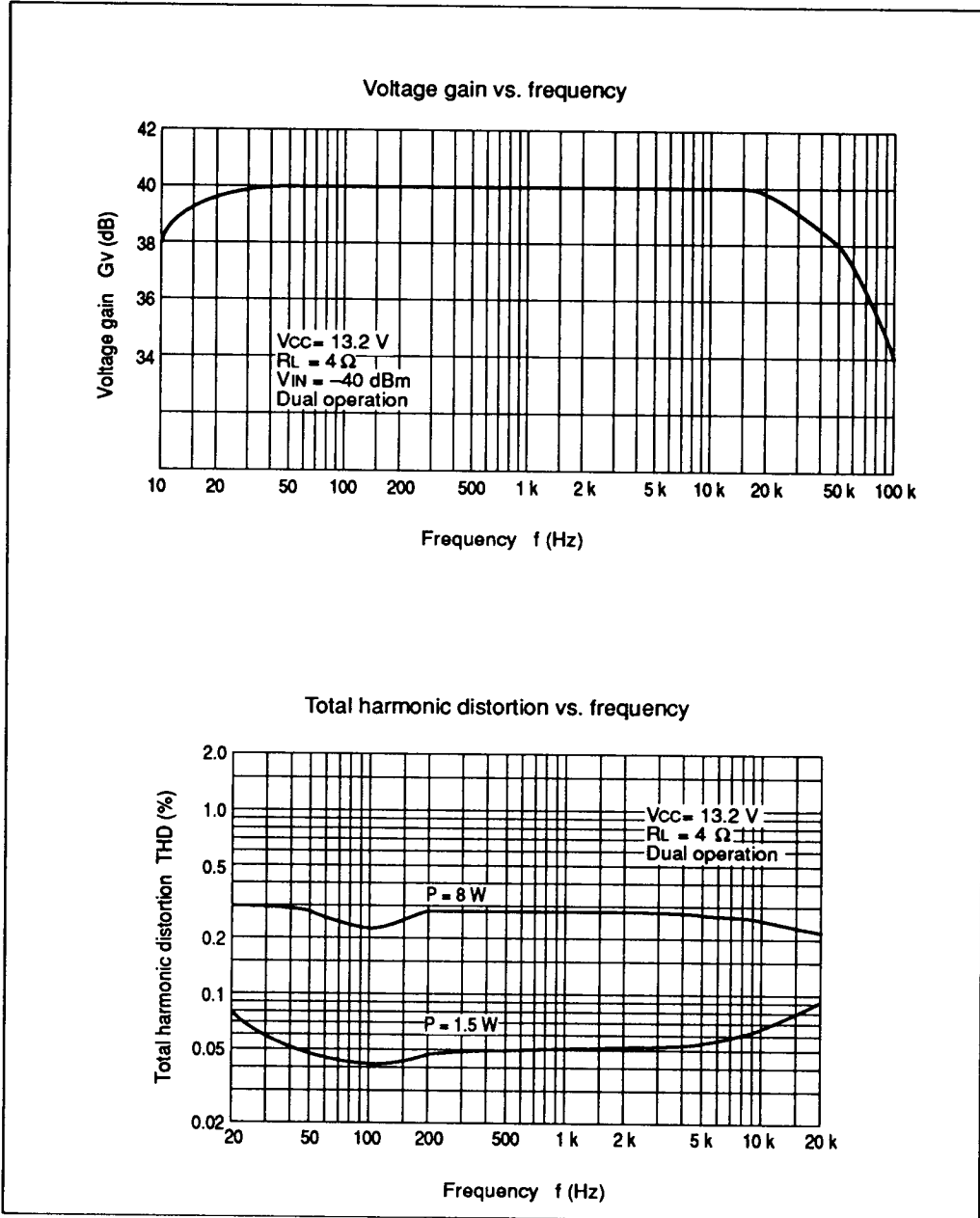
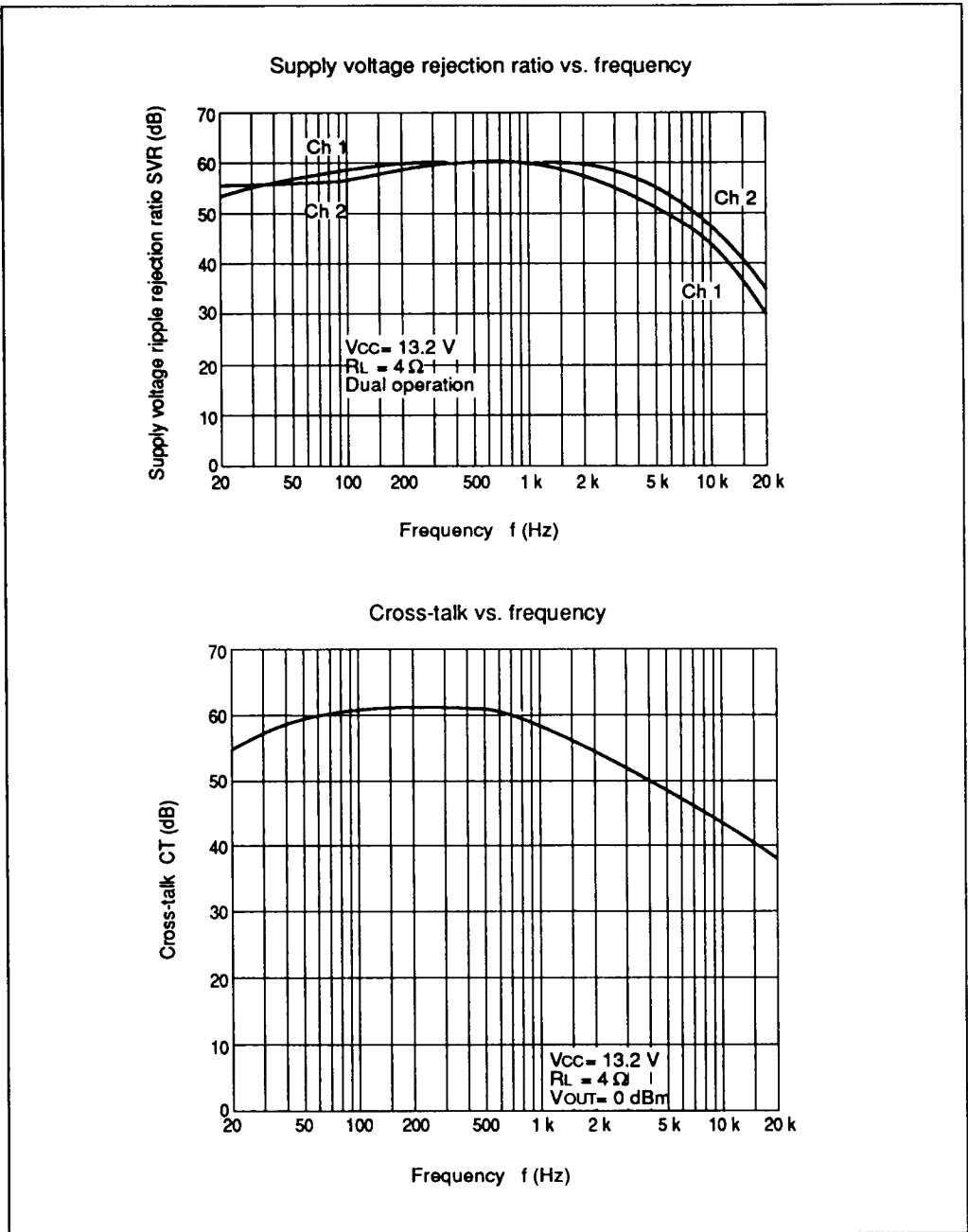

Figure 2 HA13130 Characteristic Curves (cont)





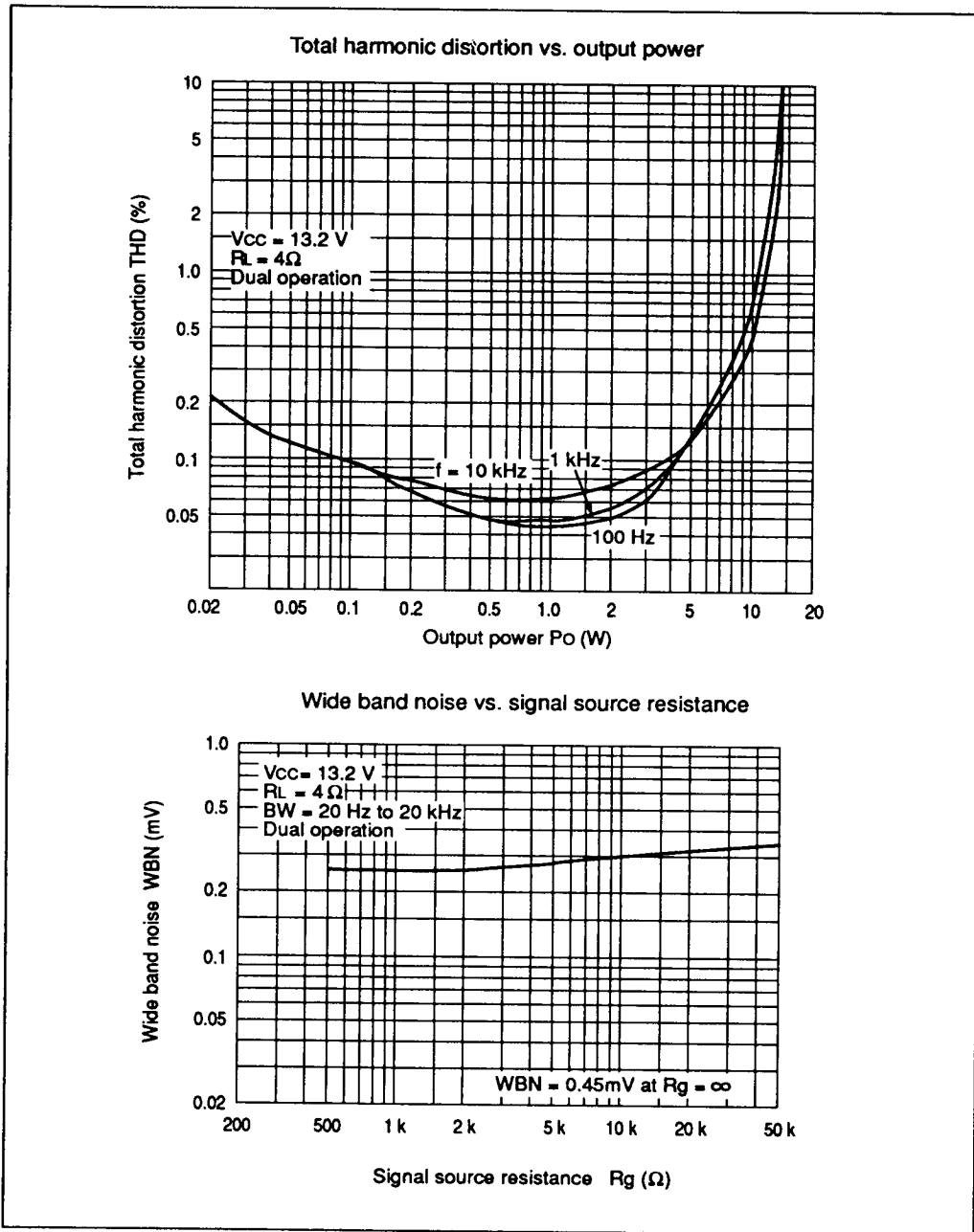

Figure 2 HA13130 Characteristic Curves (cont)



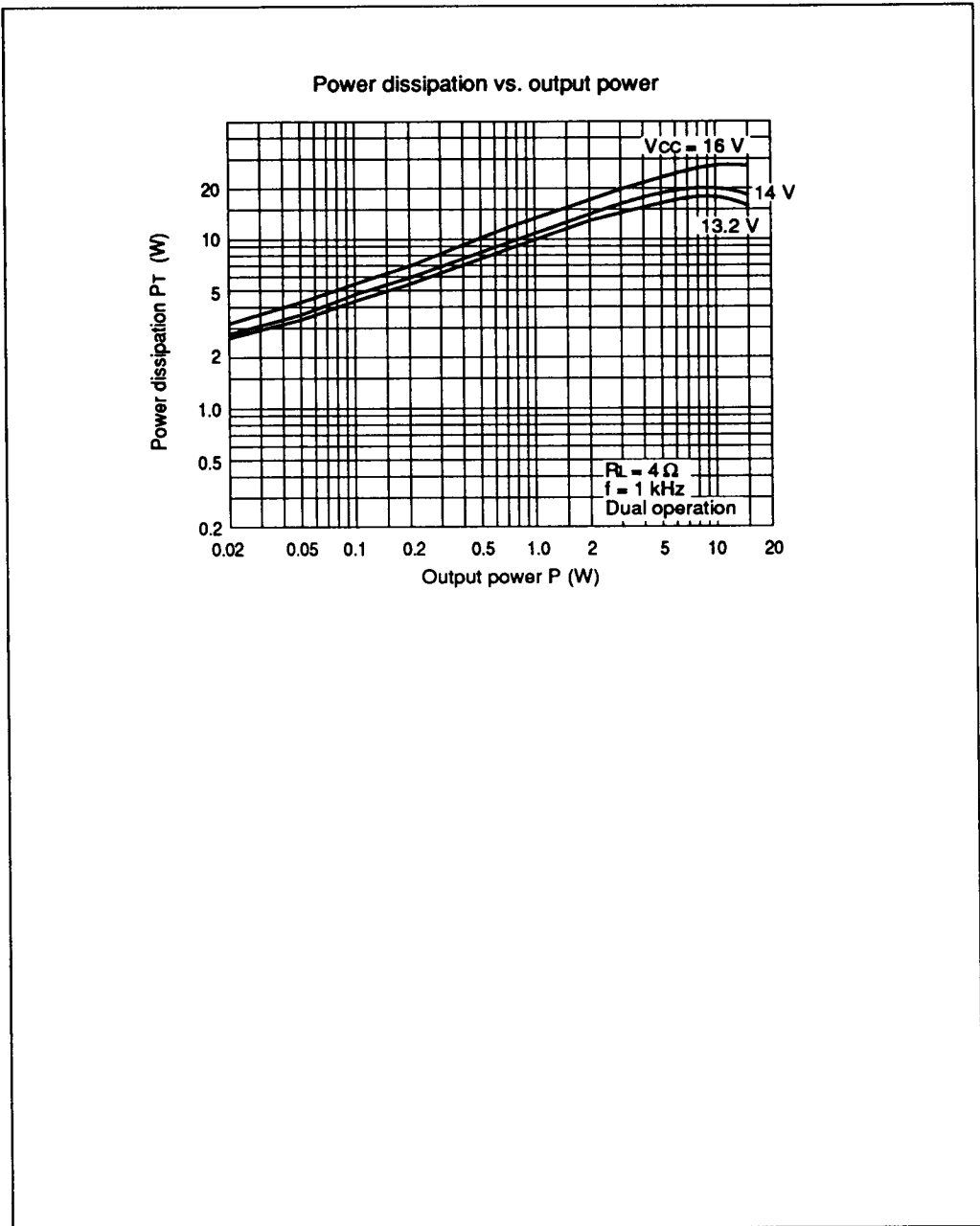
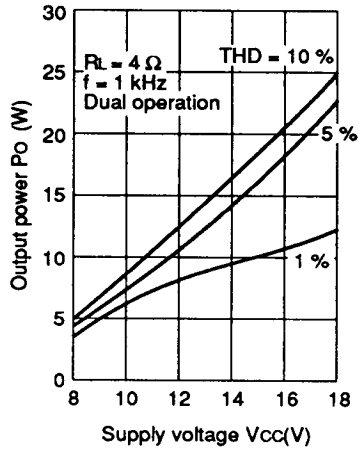

Figure 2 HA13130 Characteristic Curves (cont)



Power dissipation vs. output power (1)



Power dissipation vs. output power (2)

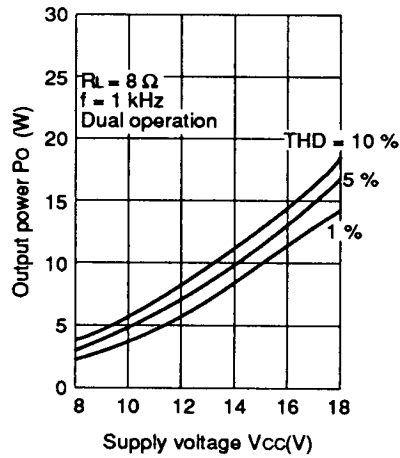

Figure 3 HA13127 Characteristic Curves



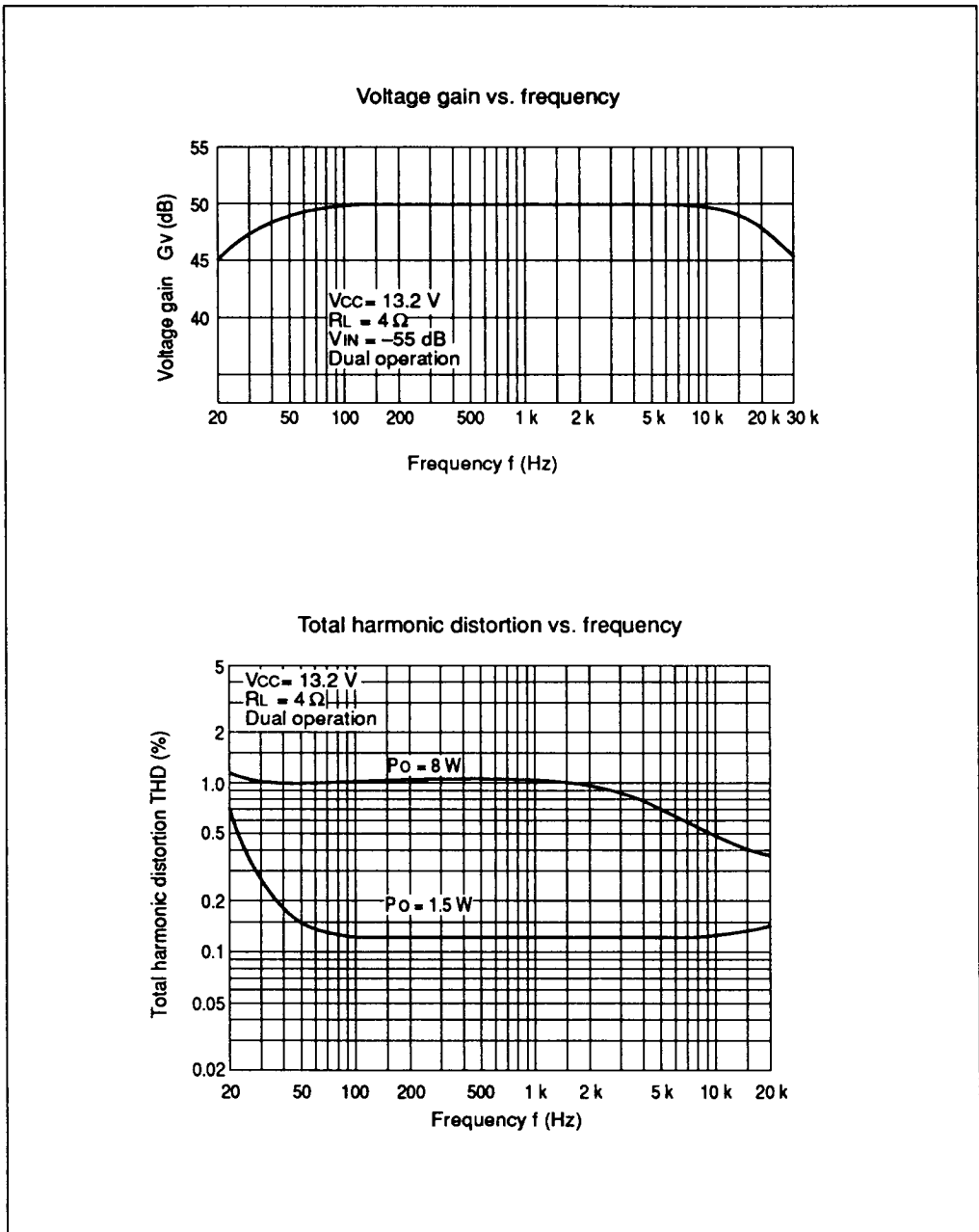

Figure 3 HA13127 Characteristic Curves (cont)



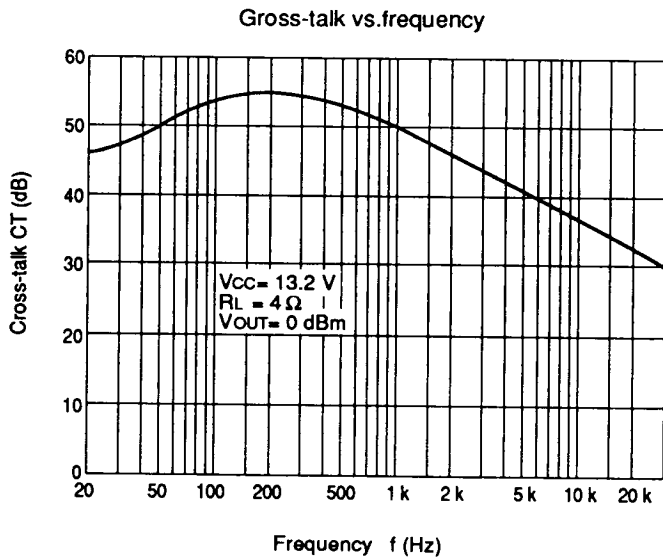
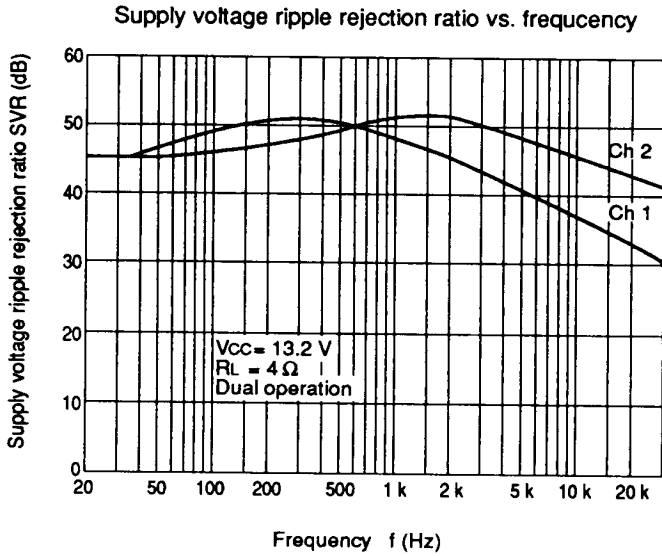

Figure 3 HA13127 Characteristic Curves (cont)



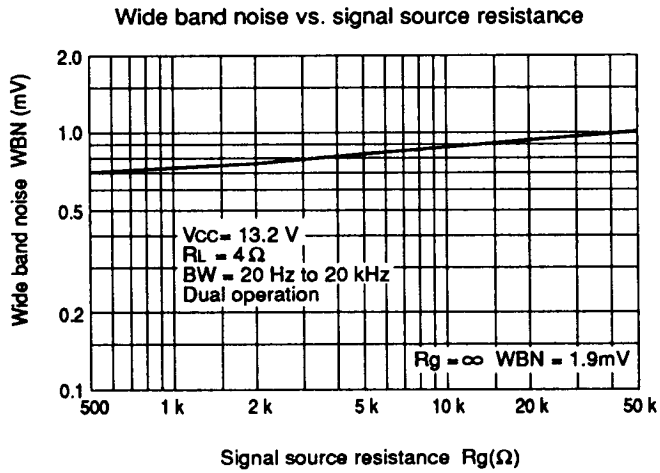
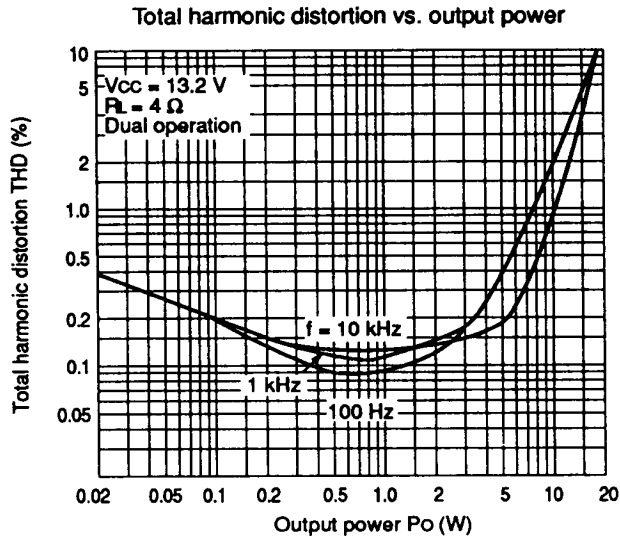

Figure 3 HA13127 Characteristic Curves (cont)



This datasheet has been downloaded from:

www.DatasheetCatalog.com

Datasheets for electronic components.



LittleDiode supplies new, hard to find or obsolete electronic components and semiconductors all over the world.

With over two million different components listed you are sure to find the part you need.

Feel free to visit us today at our online store:

LittleDiode.com

Looking forward to providing you with the best possible service.