

# Power MOSFET/IGBT Gate Drive Optocouplers

## Technical Data

### HCPL-3100 HCPL-3101

#### Features

- **High Output Current**  
 $I_{O1}$  and  $I_{O2}$  (0.4 A Peak, 0.1 A Continuous)
- **1.5 kV/ $\mu$ s Minimum Common Mode Rejection (CMR) at  $V_{CM} = 600$  V**
- **Wide Operating  $V_{CC}$  Range (15 to 30 Volts)**
- **High Speed**  
1  $\mu$ s Typical Propagation Delay (HCPL-3100)  
0.3  $\mu$ s Typical Propagation Delay (HCPL-3101)
- **Recognized under UL 1577 for Dielectric Withstand Proof Test Voltages of 5000 Vac, 1 Minute**

#### Applications

- **Isolated MOSFET/IGBT Gate Drive**
- **AC and DC Motor Drives**
- **General Purpose Industrial Inverters**
- **Uninterruptable Power Supply**

#### Description

The HCPL-3100/3101 consists of an LED\* optically coupled to an integrated circuit with a power output stage. These optocouplers are suited for driving power MOSFETs and IGBTs used in motor control inverter applications. The high operating voltage range of the output stage provides the voltage drives required by gate controlled devices. The voltage and current supplied by these optocouplers allow for direct interfacing to the power device without the need for an intermediate amplifier stage.

The HCPL-3100 switches a 3000 pF load in 2  $\mu$ s and the HCPL-3101, using a higher speed LED, switches a 3000 pF load in 0.5  $\mu$ s. With a CMR rating of 5 kV/ $\mu$ s typical these optocouplers readily reject transients found in inverter applications.

The LED controls the state of the output stage. Transistor Q2 in the output stage is on with the LED off, allowing the gate of the power device to be held low. Turning on the LED turns off transistor Q2 and switches on transistor Q1 in the output stage which provides current and voltage to drive the gate of the power device.

#### Functional Diagram

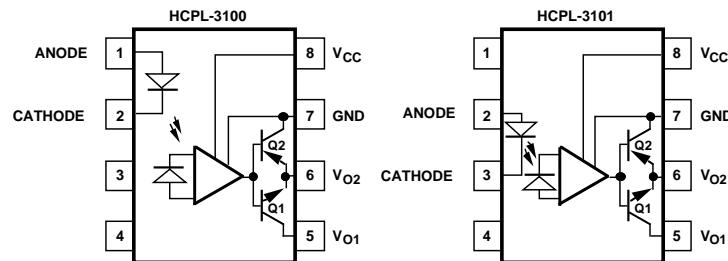

TRUTH TABLE

LED	OUTPUT	Q1	Q2
ON	HIGH LEVEL	ON	OFF
OFF	LOW LEVEL	OFF	ON

THE USE OF A 0.1  $\mu$ F BYPASS CAPACITOR CONNECTED BETWEEN PINS 8 AND 7 IS RECOMMENDED. ALSO CURRENT LIMITING RESISTOR IS RECOMMENDED (SEE FIGURE 1, AND NOTE 2 AND NOTE 7).

\*HCPL-3100 LED contains Silicon-doped GaAs and HCPL-3101 LED contains AlGaAs.

*CAUTION: It is advised that normal static precautions be taken in handling and assembly of this component to prevent damage and/or degradation which may be induced by ESD.*

## Schematic

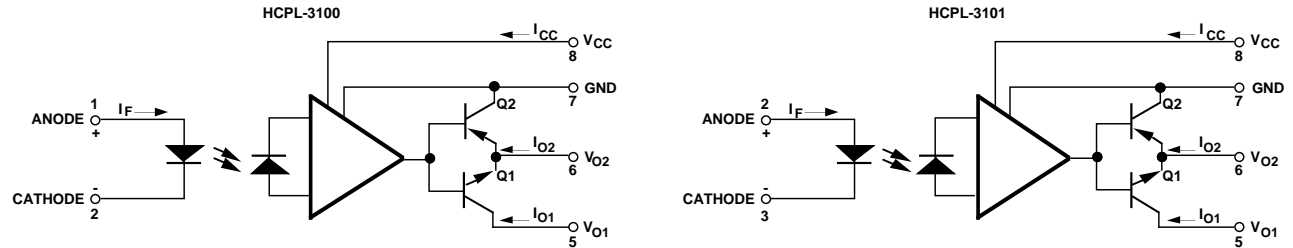

THE USE OF A 0.1  $\mu$ F BYPASS CAPACITOR CONNECTED BETWEEN PINS 8 AND 7 IS RECOMMENDED. ALSO CURRENT LIMITING RESISTOR IS RECOMMENDED (SEE FIGURE 1, AND NOTE 2 AND NOTE 7).

## Outline Drawing

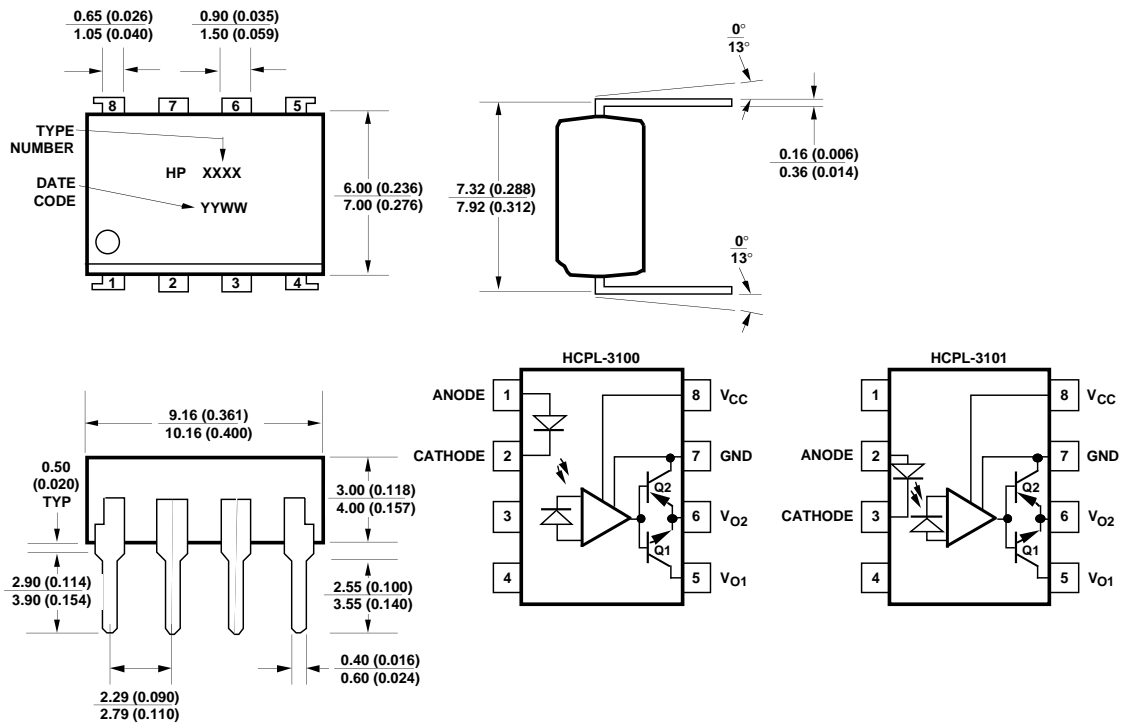

## Demonstrated ESD Performance

Human Body Model: MIL-STD-883 Method 3015.7: Class 2  
Machine Model: EIAJ IC-121-1988 (1988.3.28 Version 2), Test Method 20, Condition C: 1200 V

## Regulatory Information

The HCPL-3100/3101 has been approved by the following organization:

**UL**  
Recognized under UL 1577, Component Recognition Program, File E55361.

## Insulation and Safety Related Specifications

Parameter	Symbol	Value	Units	Conditions
Min. External Air Gap (External Clearance)	L(IO1)	6.0	mm	Shortest distance measured through air, between two conductive leads, input to output
Min. External Tracking Path (External Creepage)	L(IO2)	6.0	mm	Shortest distance path measured along outside surface of optocoupler body between input and output leads
Min. Internal Plastic Gap (Internal Clearance)		0.15	mm	Through insulation distance conductor to conductor inside the optocoupler cavity

## Absolute Maximum Ratings

Parameter		Symbol	Device	Min.	Max.	Unit	Conditions	Fig.	Note
Storage Temperature		$T_S$		-55	125	°C			
Operating Temperature		$T_A$		-25	80	°C			
Input	Continuous Current	$I_F$	HCPL-3100		25	mA	$T_A = 25^\circ\text{C}$	11	1
			HCPL-3101		20	mA		11	1
	Reverse Voltage	$V_R$			6	V			
Supply Voltage		$V_{CC}$			35	V			
Output 1	Continuous Current	$I_{O1}$			0.1	A			1
	Peak Current				0.4	A	Pulse Width < 0.15 $\mu\text{s}$ , Duty cycle = 1%		1
	Voltage		$V_{O1}$			35	V		
Output 2	Continuous Current	$I_{O2}$			0.1	A			1
	Peak Current				0.4	A	Pulse Width < 0.15 $\mu\text{s}$ , Duty cycle = 1%		1
Output Power Dissipation		$P_O$			500	mW		12	1
Total Power Dissipation		$P_T$			550	mW		12	1
Lead Solder Temperature		260°C for 10 s, 1.0 mm below seating plane							

## Recommended Operating Conditions

Parameter	Symbol	Device	Min.	Max.	Units
Power Supply Voltage	$V_{CC}$		15	30*	V
			15	24	V
Input Current (ON)	$I_{F(ON)}$	HCPL-3100	12**	24	mA
		HCPL-3101	8**	16	mA
Input Current (OFF)	$I_{F(OFF)}$	HCPL-3100	-	0.6	mA
		HCPL-3101	-	0.2	mA
Operating Temperature	$T_A$		-25	80	°C

\*For  $T_A = -10^{\circ}\text{C}$  to  $60^{\circ}\text{C}$ .

\*\*The initial switching threshold is 10 mA or less for the HCPL-3100 and 5 mA or less for the HCPL-3101.

## Recommended Protection for Output Transistors

During switching transitions, the output transistors Q1 and Q2 of the HCPL-3100/3101 can conduct large amounts of current. Figure 1 describes a recommended circuit design showing a current

limiting resistor  $R_2$  which is necessary in order to prevent damage to the output transistors Q1 and Q2. (See Note 7.) A bypass capacitor  $C_1$  is also recommended to reduce power supply noise.

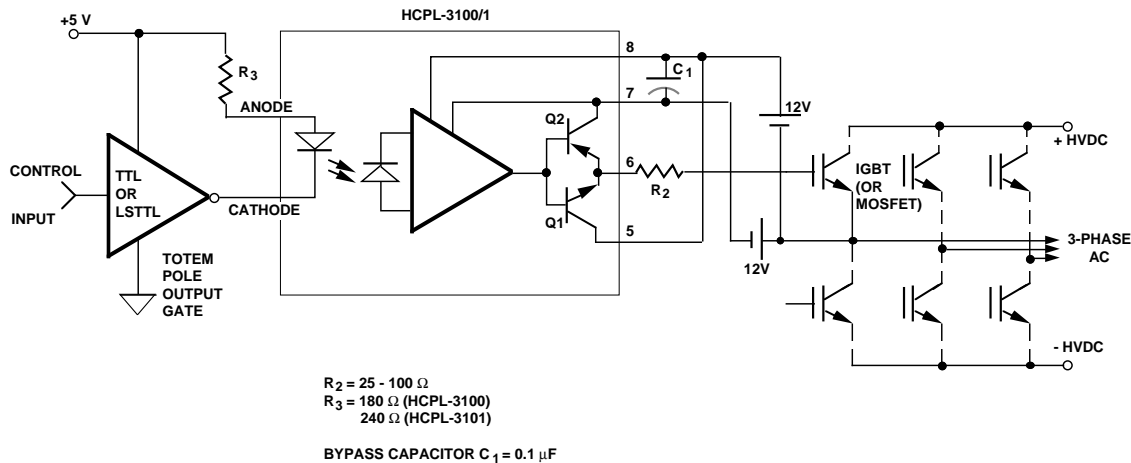

Figure 1. Recommended Output Transistor Protection and Typical Application Circuit.

## Electrical Specifications

Over recommended temperature ( $T_A = -25^\circ\text{C}$  to  $+80^\circ\text{C}$ ) unless otherwise specified.

Parameter		Sym.	Device	Min.	Typ.	Max.	Units	Test Conditions		Fig.	Note
Input Forward Voltage		$V_F$	HCPL-3100	-	1.2	1.4	V	$I_F = 20\text{ mA}$	$T_A = 25^\circ\text{C}$	13	
				0.6	0.9	-	V	$I_F = 0.2\text{ mA}$			
		HCPL-3101	-	1.6	1.75	V	$I_F = 10\text{ mA}$	14			
			1.2	1.5	-	V	$I_F = 0.2\text{ mA}$				
Input Reverse Current		$I_R$	HCPL-3100	-	-	10	$\mu\text{A}$	$V_R = 4\text{ V}$	$T_A = 25^\circ\text{C}$		
			HCPL-3101					$V_F = 5\text{ V}$			
Input Capacitance		$C_{IN}$		-	30	250	pF	$V_F = 0\text{ V}, f = 1\text{ kHz}, T_A = 25^\circ\text{C}$			
Output 1	Low Level Voltage	$V_{O1L}$	HCPL-3100	-	0.2	0.4	V	$I_F = 10\text{ mA}$	$V_{CC1} = 12\text{ V}, I_{O1} = 0.1\text{ A}, V_{CC2} = -12\text{ V}$	2, 17, 18	2
	HCPL-3101						$I_F = 5\text{ mA}$				
	Leakage Current	$I_{O1L}$		-	-	500	$\mu\text{A}$	$V_{CC} = V_{O1} = 35\text{ V}, V_{O2} = 0\text{ V}, I_F = 0\text{ mA}, T_A = 25^\circ\text{C}$		5	
Output 2	High Level Voltage	$V_{O2H}$	HCPL-3100	18	21	-	V	$I_F = 10\text{ mA}$	$V_{CC} = 24\text{ V}, V_{O1} = 24\text{ V}, I_{O2} = -0.1\text{ A}$	3, 19, 20	2
			HCPL-3101					$I_F = 5\text{ mA}$			
	Low Level Voltage	$V_{O2L}$		-	1.2	2.0	V	$V_{CC} = V_{O1} = 24\text{ V}, I_{O2} = 0.1\text{ A}, I_F = 0\text{ mA}$		4, 21, 22	
	Leakage Current	$I_{O2L}$	HCPL-3100	-	-	500	$\mu\text{A}$	$I_F = 10\text{ mA}$	$V_{CC} = 35\text{ V}, V_{O2} = 35\text{ V}, T_A = 25^\circ\text{C}$	6	
HCPL-3101							$I_F = 5\text{ mA}$				
Supply Current	High Level	$I_{CCH}$	HCPL-3100	-	6	10	mA	$T_A = 25^\circ\text{C}$	$V_{O1} = 24\text{ V}$	7, 23	2
				-	-	14	mA	$V_{CC} = 24\text{ V}, I_F = 10\text{ mA}$			
			HCPL-3101	-	6	10	mA	$T_A = 25^\circ\text{C}$	$V_{O1} = 24\text{ V}$		
				-	-	14	mA	$V_{CC} = 24\text{ V}, I_F = 5\text{ mA}$			
	Low Level	$I_{CCL}$		-	8	13	mA	$T_A = 25^\circ\text{C}$	$V_{O1} = 24\text{ V}$	7, 24	
				-	-	17	mA	$V_{CC} = 24\text{ V}, I_F = 0\text{ mA}$			
Low to High Threshold Input		$I_{FLH}$	HCPL-3100	1.0	4.0	7.0	mA	$T_A = 25^\circ\text{C}$		8, 15, 16	2, 3
				0.6	-	10.0	mA	$V_{CC} = V_{O1} = 24\text{ V}$			
			HCPL-3101	0.3	1.5	3.0	mA	$T_A = 25^\circ\text{C}$			
				0.2	-	5.0	mA	$V_{CC} = V_{O1} = 24\text{ V}$			

## Switching Specifications ( $T_A = 25^\circ\text{C}$ )

Parameter	Sym.	Device	Min.	Typ.	Max.	Units	Test Conditions	Fig.	Note
Propagation Delay Time to High Output Level	$t_{PLH}$	HCPL-3100	-	1	2	$\mu\text{s}$	$I_F = 10\text{ mA}$	$V_{CC} = 24\text{ V}$ , $V_{O1} = 24\text{ V}$ , $R_G = 47\ \Omega$ , $C_G = 3000\text{ pF}$	9, 25, 26, 27
		HCPL-3101	-	0.3	0.5	$\mu\text{s}$	$I_F = 5\text{ mA}$		
Propagation Delay Time to Low Output Level	$t_{PHL}$	HCPL-3100	-	1	2	$\mu\text{s}$	$I_F = 10\text{ mA}$		
		HCPL-3101	-	0.3	0.5	$\mu\text{s}$	$I_F = 5\text{ mA}$		
Rise Time	$t_r$	HCPL-3100	-	0.2	0.5	$\mu\text{s}$	$I_F = 10\text{ mA}$		
		HCPL-3101	-	0.2	0.5	$\mu\text{s}$	$I_F = 5\text{ mA}$		
Fall Time	$t_f$	HCPL-3100	-	0.2	0.5	$\mu\text{s}$	$I_F = 10\text{ mA}$		
		HCPL-3101	-	0.2	0.5	$\mu\text{s}$	$I_F = 5\text{ mA}$		
Output High Level Common Mode Transient Immunity	$ CM_H $	HCPL-3100	1500	5000	-	$\text{V}/\mu\text{s}$	$I_F = 10\text{ mA}$	10	2
		HCPL-3101	1500	5000	-	$\text{V}/\mu\text{s}$	$I_F = 5\text{ mA}$		
Output Low Level Common Mode Transient Immunity	$ CM_L $	HCPL-3100	1500	5000	-	$\text{V}/\mu\text{s}$	$I_F = 0\text{ mA}$		
		HCPL-3101	1500	5000	-	$\text{V}/\mu\text{s}$	$I_F = 0\text{ mA}$		

## Packaging Characteristics

Parameter	Sym.	Min.	Typ.	Max.	Units	Test Conditions	Fig.	Note
Input-Output Momentary Withstand Voltage*	$V_{ISO}$	5000			V rms	RH = 40% to 60% $t = 1\text{ min}$ , $T_A = 25^\circ\text{C}$		4, 5
Resistance (Input-Output)	$R_{I-O}$	$5 \times 10^{10}$	$10^{11}$	-	$\Omega$	$V_{I-O} = 500\text{ V}$ , $T_A = 25^\circ\text{C}$ RH = 40% to 60%		4
Capacitance (Input-Output)	$C_{I-O}$	-	1.2	-	pF	$f = 1\text{ MHz}$		4

\*The Input-Output Momentary Withstand Voltage is a dielectric voltage rating that should not be interpreted as an input-output continuous voltage rating. For the continuous voltage rating refer to the VDE 0884 Insulation Characteristics Table (if applicable), your equipment level safety specification, or HP Application Note 1074, "Optocoupler Input-Output Endurance Voltage."

### Notes:

- Derate absolute maximum ratings with ambient temperatures as shown in Figures 11 and 12.
- A bypass capacitor of 0.01  $\mu\text{F}$  or more is needed near the device between  $V_{CC}$  and GND when measuring output and transfer characteristics.
- $I_{FLH}$  represents the forward current when the output goes from low to high.
- Device considered a two terminal device; pins 1-4 are shorted together and pins 5-8 are shorted together.
- For devices with minimum  $V_{ISO}$  specified at 5000 V rms, in accordance with UL 1577, each optocoupler is proof-tested by applying an insulation test voltage  $\geq 6000\text{ V rms}$  for one second (leakage current detection limit,  $I_{L-O} \leq 200\ \mu\text{A}$ ).
- The  $t_{PLH}$  and  $t_{PHL}$  propagation delays are measured from the 50% level of the input pulse to the 50% level of the output pulse.
- $R_2$  limits the Q1 and Q2 peak currents. For more applications and circuit design information see Application Note "Power Transistor Gate/Base Drive Optocouplers."

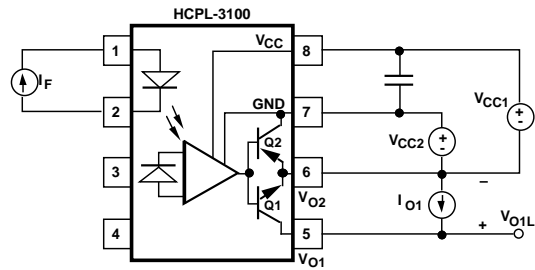

Figure 2. Test Circuit for Low Level Output Voltage  $V_{O1L}$ .

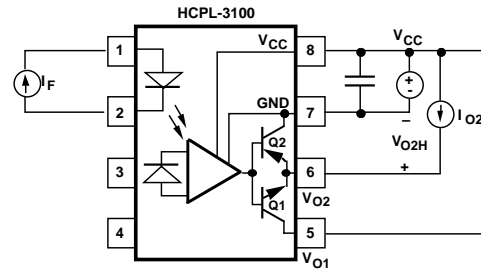

Figure 3. Test Circuit for High Level Output Voltage  $V_{O2H}$ .

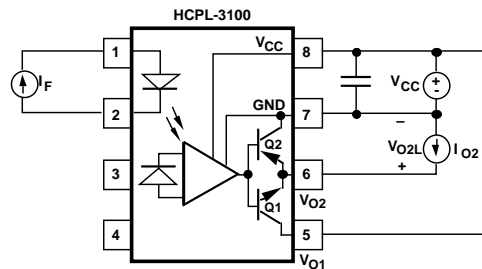

Figure 4. Test Circuit for Low Level Output Voltage  $V_{O2L}$ .

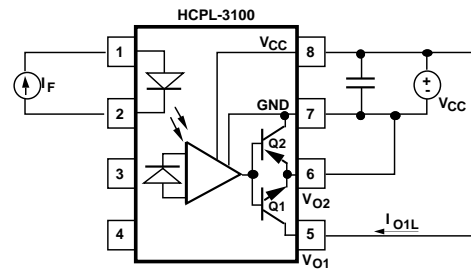

Figure 5. Test Circuit for Leakage Current  $I_{O1L}$ .

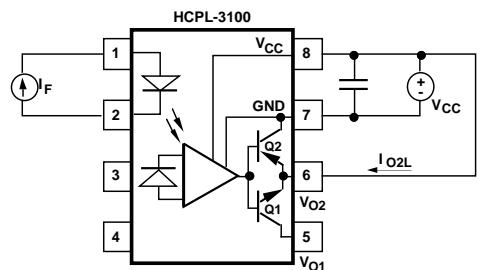

Figure 6. Test Circuit for Leakage Current  $I_{O2L}$ .

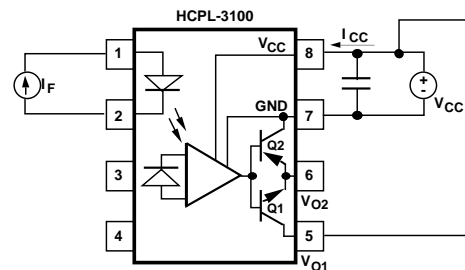

Figure 7. Test Circuit for  $I_{CCH}$  and  $I_{CCL}$ .

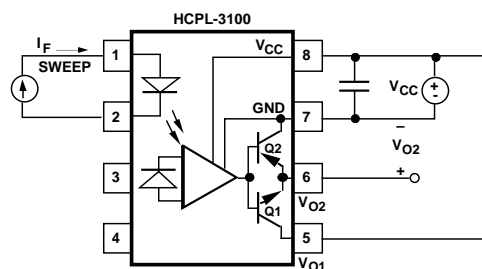

Figure 8. Test Circuit for Threshold Input Current  $I_{FLH}$ .

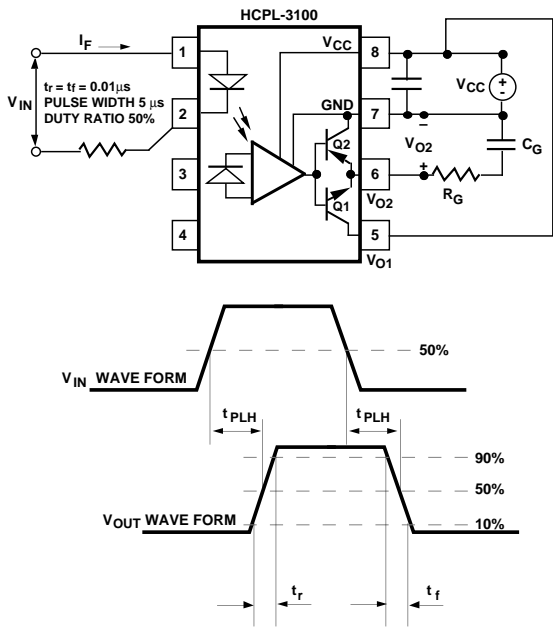

Figure 9. Test Circuit for  $t_{PLH}$ ,  $t_{PHL}$ ,  $t_r$ , and  $t_f$ .

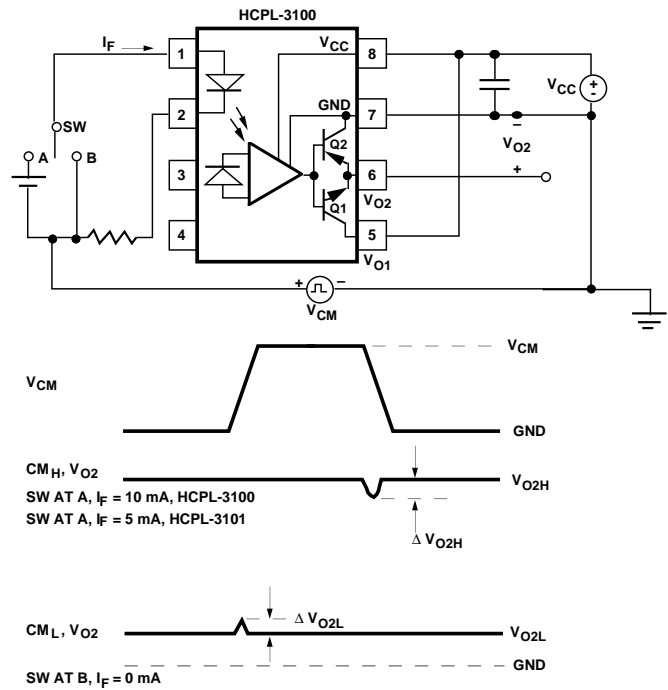

Figure 10. Test Circuit for  $CM_H$  and  $CM_L$ .

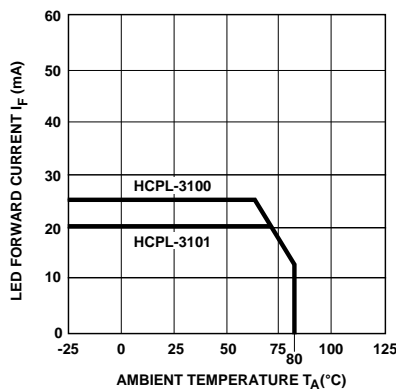

Figure 11. LED Forward Current vs. Ambient Temperature.

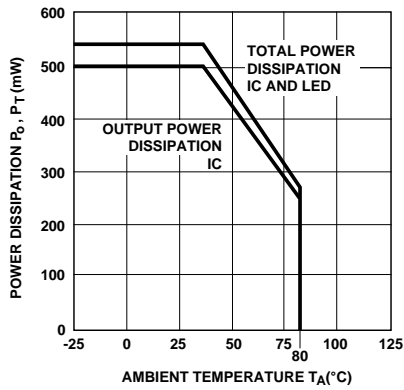

Figure 12. Maximum Power Dissipation vs. Ambient Temperature.

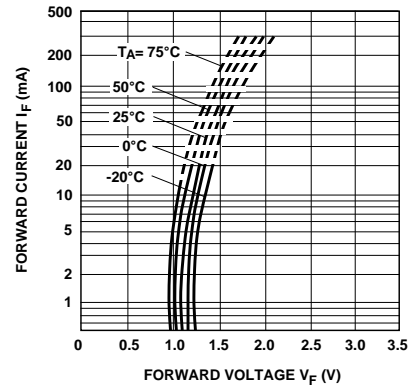

Figure 13. Typical Forward Current vs. Forward Voltage, HCPL-3100.

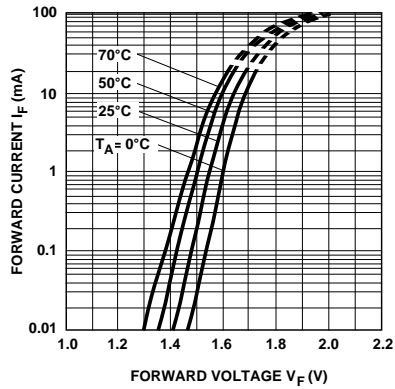

Figure 14. Typical Forward Current vs. Forward Voltage, HCPL-3101.

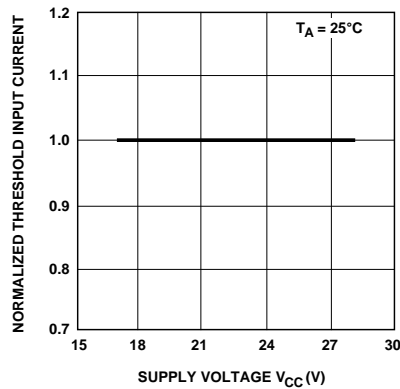

Figure 15. Normalized Low to High Threshold Input Current vs. Supply Voltage.

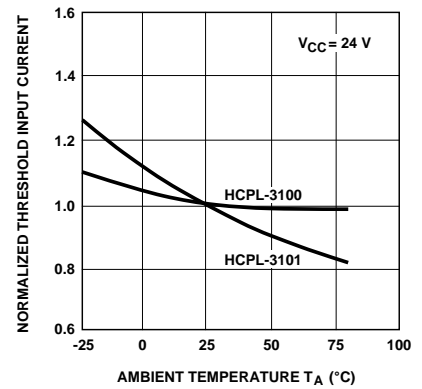

Figure 16. Normalized Low to High Threshold Input Current vs. Ambient Temperature.

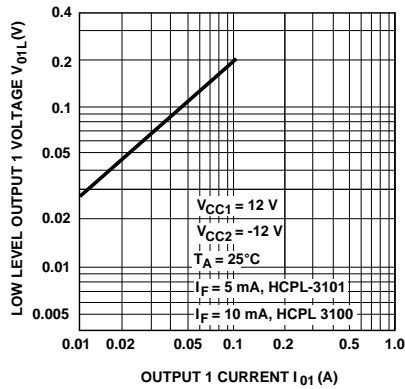

Figure 17. Typical Low Level Output 1 Voltage vs. Output 1 Current.

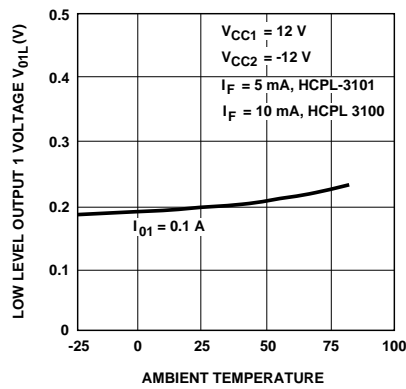

Figure 18. Typical Low Level Output 1 Voltage vs. Ambient Temperature.

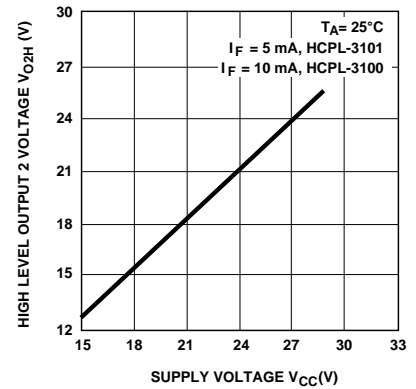

Figure 19. Typical High Level Output 2 Voltage vs. Supply Voltage.

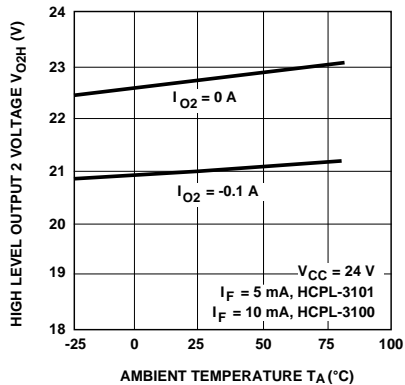

Figure 20. Typical High Level Output 2 Voltage vs. Ambient Temperature.

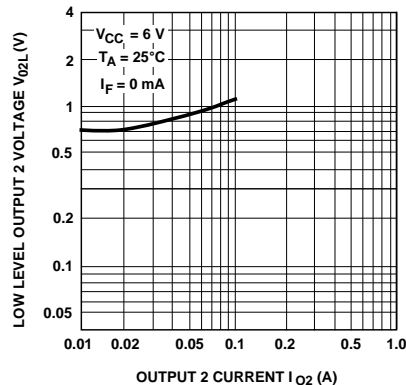

Figure 21. Typical Low Level Output 2 Voltage vs. Output 2 Current.

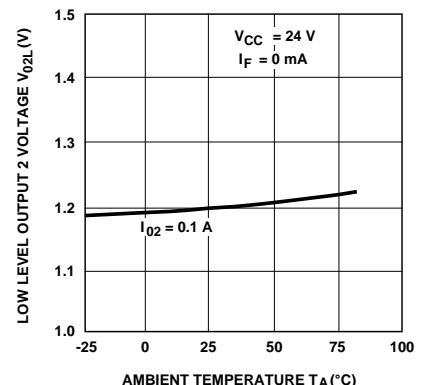

Figure 22. Typical Low Level Output 2 Voltage vs. Ambient Temperature.

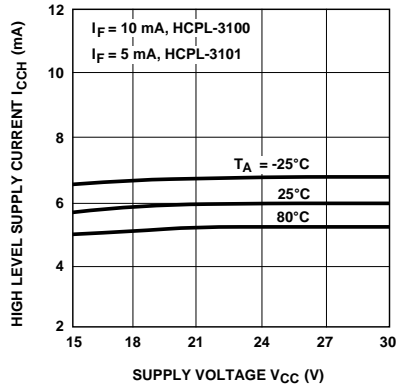

Figure 23. Typical High Level Supply Current vs. Supply Voltage.

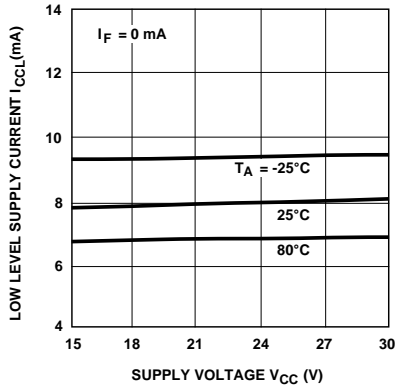

Figure 24. Typical Low Level Supply Current vs. Supply Voltage.

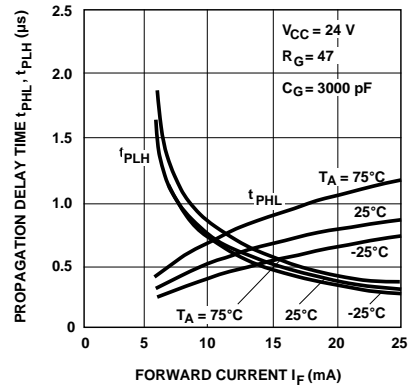

Figure 25. Typical Propagation Delay Time vs. Forward Current, HCPL-3100.

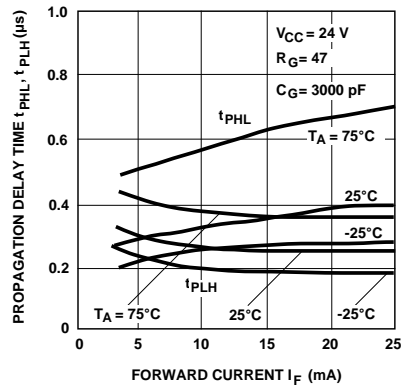

Figure 26. Typical Propagation Delay Time vs. Forward Current, HCPL-3101.

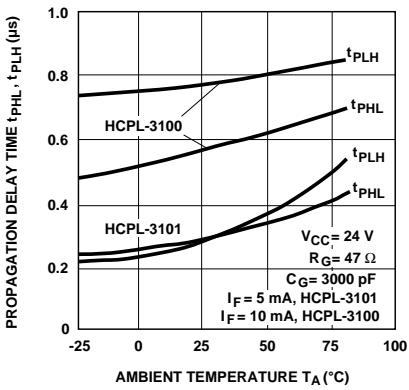

Figure 27. Typical Propagation Delay Time vs. Ambient Temperature.



LittleDiode supplies new, hard to find or obsolete electronic components and semiconductors all over the world.

With over two million different components listed you are sure to find the part you need.

Feel free to visit us today at our online store:

[LittleDiode.com](http://LittleDiode.com)

Looking forward to providing you with the best possible service.