

ABSOLUTE MAXIMUM RATING

Symbol	Parameter	Value	Unit
V_s	Power Supply Voltage	50	V
V_{SS}	Logic Supply Voltage	7	V
V_{EN}	Enable Voltage	7	V
I_p	Peak Output Current (repetitive)	4.5	A
P_{tot}	Total Power Dissipation (at $T_{case} = 75\text{ }^\circ\text{C}$)	25	W
T_{stg}, T_j	Storage and Junction Temperature	- 40 to 150	$^\circ\text{C}$

CONNECTION DIAGRAM (top view)

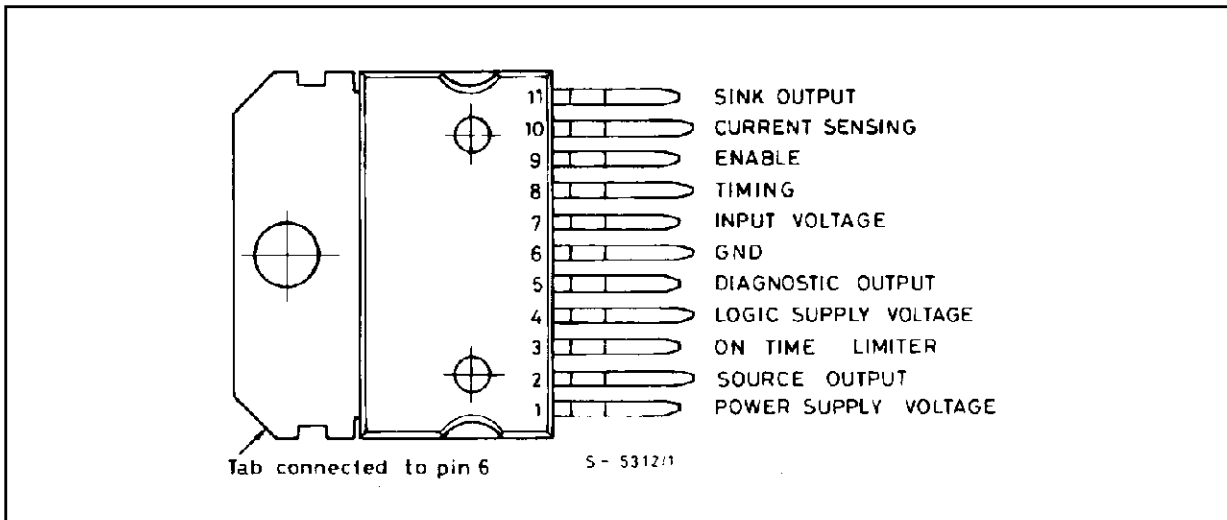

THERMAL DATA

Symbol	Parameter	Value	Unit
$R_{th-j-case}$	Thermal resistance junction-case	Max 3	$^\circ\text{C/W}$

ELECTRICAL CHARACTERISTICS (refer to the test circuit, $V_s = 40\text{ V}$, $V_{ss} = 5\text{ V}$, $T_{\text{amb}} = 25\text{ }^\circ\text{C}$, unless otherwise specified)

Symbol	Parameter	Test conditions	Min.	Typ.	Max.	Unit	
V_s	Power Supply Voltage (pin 1)	Operative Condition	12		46	V	
I_d	Quiescent Drain Current (pin 1)	$V_{\text{ENABLE}} = \text{H}$		20	30	mA	
		$V_i \geq 0.6\text{ V}$; $V_{\text{ENABLE}} = \text{L}$		70			
V_{ss}	Logic Supply Voltage (pin 4)		4.5		7	V	
I_{ss}	Quiescent Logic Supply Current	$V_{\text{DIAG}} = \text{L}$		5	8	mA	
		DIAG Output at High Impedance		10	100		μA
V_i	Input Voltage (pin 7)	Operating Output	0.6			V	
		Non-operative Output			0.45		
I_i	Input Current (pin 7)	$V_i \geq 0.6\text{ V}$		-1		μA	
		$V_i \leq 0.45\text{ V}$		-3			
V_{ENABLE}	Enable Input Voltage (pin 9)	Low Level	-0.3		0.8	V	
		High Level	2.4				
I_{ENABLE}	Enable Input Current (pin 9)	$V_{\text{ENABLE}} = \text{L}$			-100	μA	
		$V_{\text{ENABLE}} = \text{H}$			100		
I_{load}/ V_i	Transconductance	$R_s = 0.2\ \Omega$	$V_i = 1\text{ V}$	0.95	1	1.05	A/V
			$V_i = 4\text{ V}$	0.97	1	1.3	
$V_{\text{sat H}}$	Source Output Saturation Voltage	$I_p = 4\text{ A}$		1.7		V	
$V_{\text{sat L}}$	Sink Output Saturation Voltage	$I_p = 4\text{ A}$		2		V	
$V_{\text{sat H}} + V_{\text{sat L}}$	Total Saturation Voltage	$I_p = 4\text{ A}$			4.5	V	
I_{leakage}	Output Leakage Current	$R_s = 0.2\ \Omega$; $V_i \leq 0.45\text{ V}$		1		mA	
K	On Time Limiter Constant ($^\circ$)	$V_{\text{ENABLE}} = \text{L}$		120			
V_{DIAG}	Diagnostic Output Voltage (pin 5)	$I_{\text{DIAG}} = 10\text{ mA}$			0.4	V	
I_{DIAG}	Diagnostic Leakage Current (pin 5)	$V_{\text{DIAG}} = 40\text{ V}$			10	μA	
$\frac{V_{\text{pin 8}}}{V_{\text{pin 10}}}$	OP AMP and OTACD Voltage Gain ($^\circ$)	$V_{\text{pin 10}} = 100\text{ to }800\text{ mV}$		5			
V_{SENS}	Sensing Voltage (pin 10) ($^\circ^\circ$)				0.9	V	

($^\circ$) After a time interval $t_{\text{max}} = KC_2$, the output stages are disabled.

($^\circ^\circ$) See the block diagram.

($^\circ^\circ^\circ$) Allowed range of V_{SENS} without intervention of the short circuit protection.

CIRCUIT OPERATION

The L294 work as a transconductance amplifier: it can supply an output current directly proportional to an input voltage level (V_i). Furthermore, it allows complete switching control of the output current waveform (see fig. 1).

The following explanation refers to the Block Diagram, to fig. 1 and to the typical application circuit of fig. 2.

The t_{on} time is fixed by the width of the Enable input signal (TTL compatible): it is active low and enables the output stages "source" and "sink". At the end of t_{on} , the load current I_{load} recirculates through D1 and D2, allowing fast current turn-off.

The rise time t_r , depends on the load characteristics, on V_i and on the supply voltage value (V_s , pin 1). During the t_{on} time, I_{load} is converted into a voltage signal by means of the external sensing resistance R_s connected to pin 10. This signal, amplified by the op amp and converted by the transconductance amplifier OTA, charges the external RC network at pin 8 (R1, C1). The voltage at this pin is sensed by the inverting input of a comparator. The voltage on the non-inverting input of this one is fixed by the external voltage V_i (pin 7).

After t_r , the comparator switches and the output stage "source" is switched off. The comparator output is confirmed by the voltage on the non-inverting input, which decreases of a constant fraction of V_i (1/10), allowing hysteresis operation. The current in the load now flows through D1.

Two Cases are possible: the time constant of the recirculation phase is higher than $R1.C1$; the time constant is lower than $R1.C1$. In the first case, the voltage sensed in the non-inverting input of the comparator is just the value proportional to I_{load} . In the second case, when the current decreases too quickly, the comparator senses the voltage signal stored in the R1 C1 network.

In the first case t_1 depends on the load characteristics, while in the second case it depends only on the value of $R1.C1$.

In other words, $R1.C1$ fixes the minimum value of t_1 ($t_1 \geq 1/10 R1.C1$). Note that C1 should be chosen in the range 2.7 to 10 nF for stability reasons of the OTA).

After t_1 , the comparator switches again: the output is confirmed by the voltage on the non-inverting input, which reaches V_i again (hysteresis).

Now the cycle starts again: t_2 , t_4 and t_6 have the same characteristics as t_r , while t_3 and t_5 are similar

to t_1 . The peak current I_p depends on V_i as shown in the typical transfer function of fig.3.

It can be seen that for V_i lower than 450 mV the device is not operating.

For V_i greater than 600 mV, the L294 has a transconductance of 1A/V with $R_s = 0.2\Omega$. For V_i included between 450 and 600 mV, the operation is not guaranteed.

The order parts of the device have protection and diagnostic functions. At pin 3 is connected an external capacitor C2, charged at constant current when the Enable is low.

After a time interval equal to $K C2$ (K is defined in the table of Electrical Characteristics and has the dimensions of ohms) the output stages are switched off independently by the Input signal.

This avoids the load being driven in conduction for an excessive period of time (overdriving protection). The action of this protection is shown in fig. 1b. Note that the voltage ramp at pin 3 starts whenever the Enable signal becomes active (low state), regardless of the Input signal. To reset pin 3 and to restore the normal conditions, pin 9 must return high.

This protection can be disabled by grounding pin 3. The thermal protection included in the L294 has a hysteresis.

It switches off the output stages whenever the junction temperature increases too much. After a fall of about 20°C, the circuit starts again.

Finally, the device is protected against any type of short circuit at the outputs: to ground, to supply and across the load.

When the source stage current is higher than 5A and/or when the pin 10 voltage is higher than 1V (i.e. for a sink current greater than $1V/R_s$) the output stages are switched off and the device is inhibited.

This condition is indicated at the open-collector output DIAG (pin 5); the internal flip-flop F/F changes and forces the output transistor into saturation. The F/F must be supplied independently through V_{ss} (pin 4). The DIAG signal is reset and the output stages are still operative by switching the device on again. After that, two cases are possible: the reason for the "bad operation" is still present and the protection acts again; the reason has been removed and the device starts to work properly.

Figure 1. Output Current Waveforms.

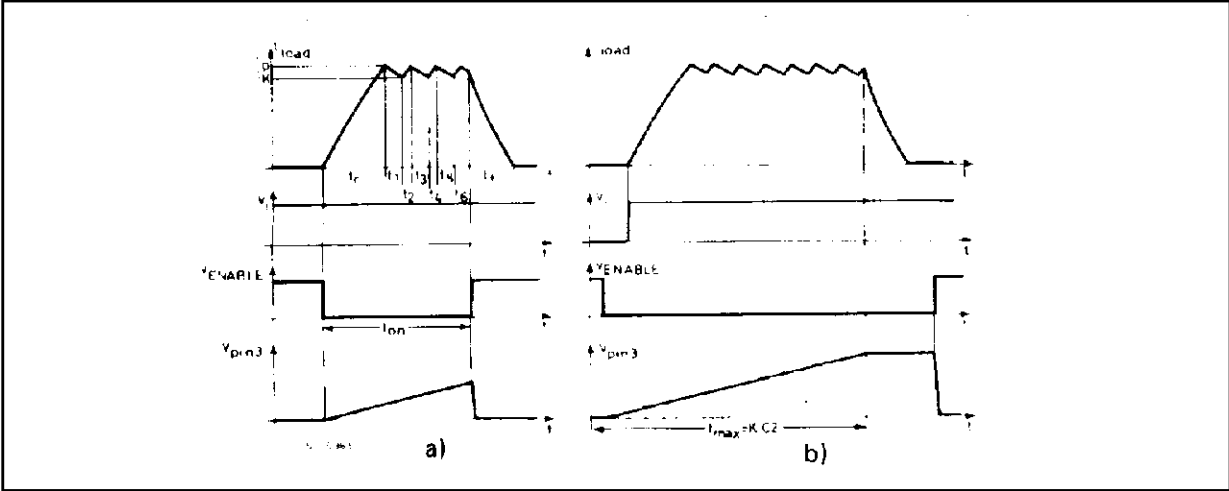

Figure 2. Test and Typical Application Circuit.

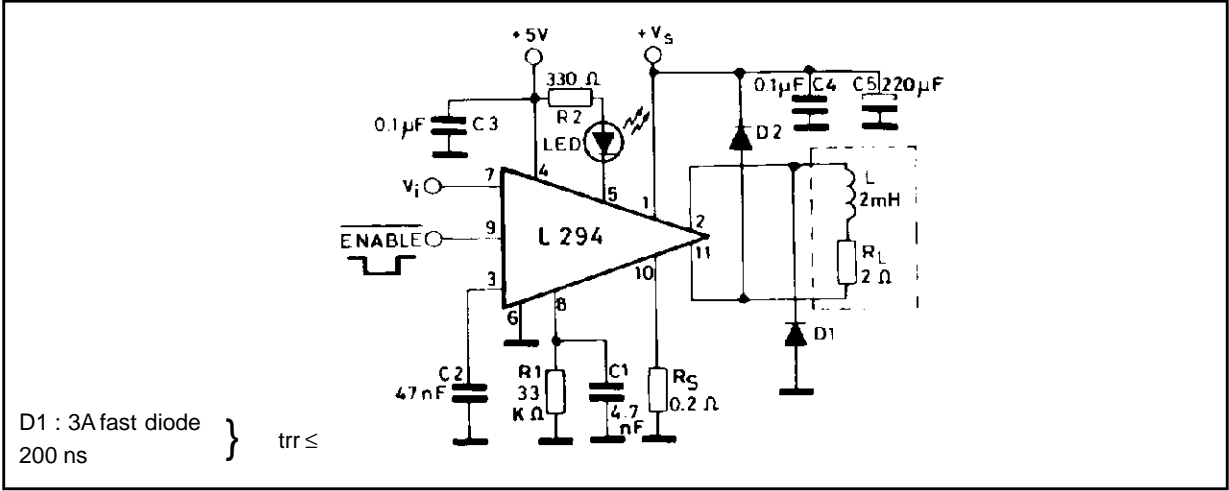

Figure 3. Peak Output Current vs. Input Voltage.

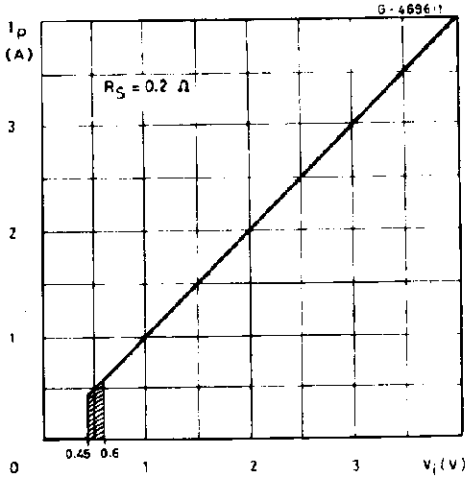

Figure 4. Output Saturation Voltage vs. Peak Output Current.

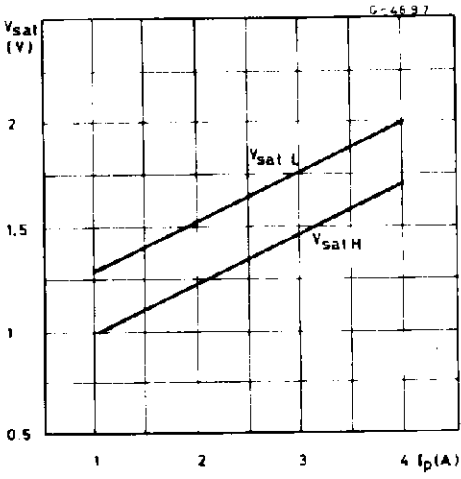

Figure 5. Safe Operating Areas.

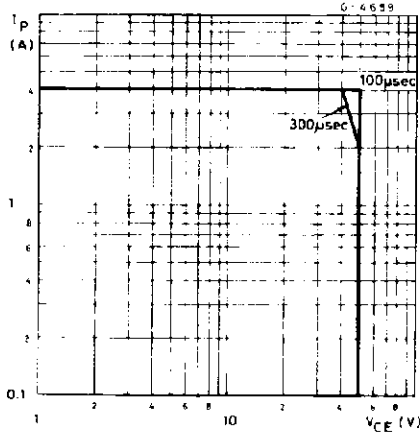
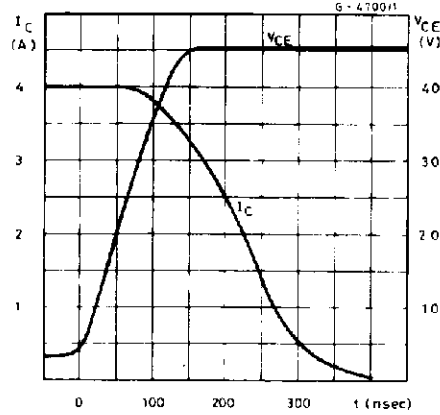

Figure 6. Turn-off Phase.



CALCULATION OF THE SWITCHING TIMES

Referring to the block diagram and to the waveforms of fig. 1, it is possible to calculate the switching times by means of the following relationships.

$$t_r = - \frac{L}{R_L} \ln \left(1 - \frac{R_L}{V_1} \cdot I_p \right)$$

where : $V_1 = V_s - V_{sat L} - V_{sat H} - V_{R sens}$

$$t_f = - \frac{L}{R_L} \ln \frac{V_2}{V_2 + R_L \cdot I_o}$$

where : $V_2 = V_s + V_{D1} + V_{D2}$

$I_k \leq I_o \leq I_p$
 I_o is the value of the load current at the end of t_{on} .

$$t_1 = t_3 = t_5 = \dots$$

$$= \begin{cases} a) - \frac{L}{R_L} \ln \frac{0.9 I_p \cdot R_L + V_3}{I_p R_L + V_3} & \text{where } V_3 = V_{sat L} + V_{R sens} + V_{D1} \\ b) - R_1 C_1 \ln 0.9 \cong \frac{1}{10} R_1 C_1 \end{cases}$$

$$t_2 = t_4 = t_6 = \dots$$

$$= - \frac{L}{R_L} \ln \left(\frac{V_1 - I_p R_L}{V_1 - I_k R_L} \right)$$

Note that the time interval $t_1 = t_3 = t_5 = \dots$ takes the longer value between case a) and case b). The switching frequency is always :

$$f_{switching} = \frac{1}{t_1 + t_2}$$

In the case a) the main regulation loop is always closed and it forces :

$$I_k = (0.9 \pm S) I_p$$

where : $S = 3 \% @ V_i = 1 V$
 $S = 1.5 \% @ V_i = 4 V$

In the case b), the same loop is open in the recirculation phase and I_k , which is always lower than $0.9 I_p$, is obtained by means of the following relationship.

$$I_k = I_p e^{-\frac{t_1 R_L}{L}} - \frac{V_3}{R_L} \left(1 - e^{-\frac{t_1 R_L}{L}} \right)$$

With the typical application circuit, in the conditions $V_s = 40V$, $I_p = 4A$, the following switching times result:

$$t_r = 255 \mu s$$

$$t_f = 174 \mu s @ I_o = I_p$$

$$t_1 = \begin{cases} a) 70 \mu s \\ b) 16 \mu s \end{cases}$$

$$t_2 = 29 \mu s$$

$$f = 10.2 KHz$$

MULTIWATT11 PACKAGE MECHANICAL DATA

DIM.	mm			inch		
	MIN.	TYP.	MAX.	MIN.	TYP.	MAX.
A			5			0.197
B			2.65			0.104
C			1.6			0.063
D		1			0.039	
E	0.49		0.55	0.019		0.022
F	0.88		0.95	0.035		0.037
G	1.57	1.7	1.83	0.062	0.067	0.072
G1	16.87	17	17.13	0.664	0.669	0.674
H1	19.6			0.772		
H2			20.2			0.795
L	21.5		22.3	0.846		0.878
L1	21.4		22.2	0.843		0.874
L2	17.4		18.1	0.685		0.713
L3	17.25	17.5	17.75	0.679	0.689	0.699
L4	10.3	10.7	10.9	0.406	0.421	0.429
L7	2.65		2.9	0.104		0.114
M	4.1	4.3	4.5	0.161	0.169	0.177
M1	4.88	5.08	5.3	0.192	0.200	0.209
S	1.9		2.6	0.075		0.102
S1	1.9		2.6	0.075		0.102
Dia1	3.65		3.85	0.144		0.152

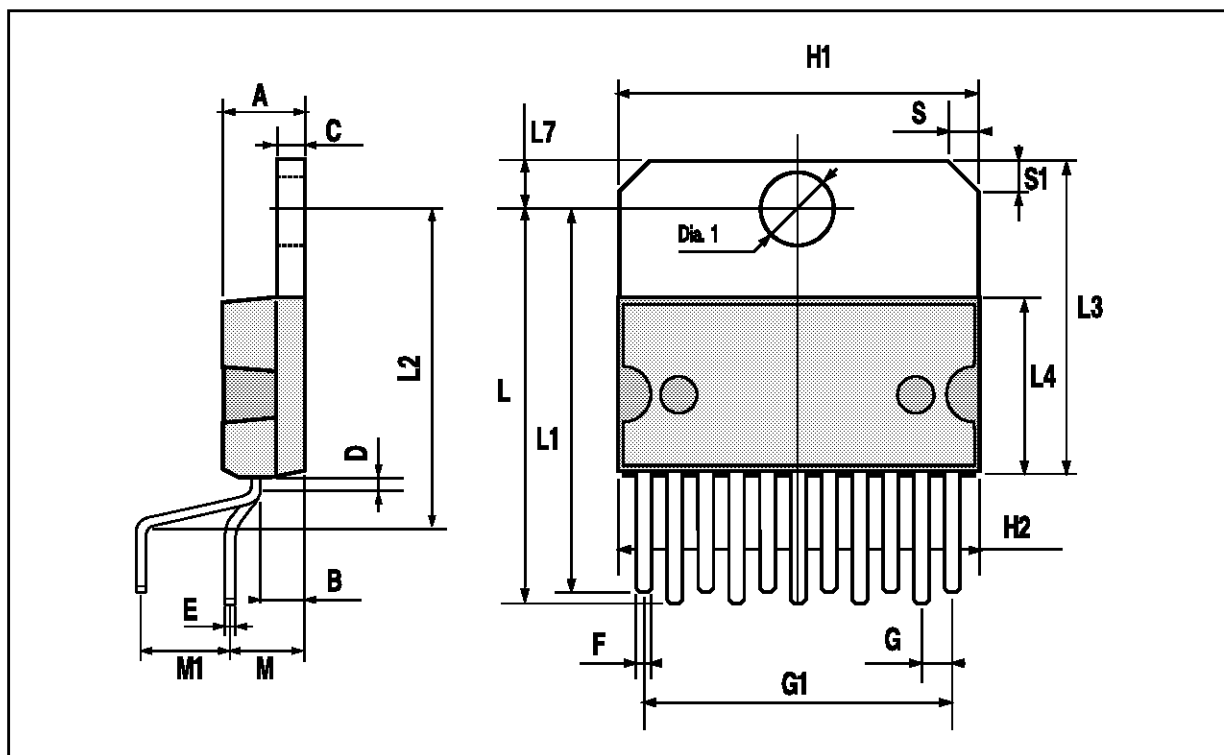

Information furnished is believed to be accurate and reliable. However, SGS-THOMSON Microelectronics assumes no responsibility for the consequences of use of such information nor for any infringement of patents or other rights of third parties which may result from its use. No license is granted by implication or otherwise under any patent or patent rights of SGS-THOMSON Microelectronics. Specifications mentioned in this publication are subject to change without notice. This publication supersedes and replaces all information previously supplied. SGS-THOMSON Microelectronics products are not authorized for use as critical components in life support devices or systems without express written approval of SGS-THOMSON Microelectronics.

© 1994 SGS-THOMSON Microelectronics - All Rights Reserved

SGS-THOMSON Microelectronics GROUP OF COMPANIES

Australia - Brazil - France - Germany - Hong Kong - Italy - Japan - Korea - Malaysia - Malta - Morocco - The Netherlands - Singapore - Spain - Sweden - Switzerland - Taiwan - Thailand - United Kingdom - U.S.A.