

APRIL. 1998

DATA SHEET

KA2500



I²C BUS CONTROLLED R/G/B VIDEO AMPLIFIER

The KA2500 is a very high frequency video amplifier system with I²C Bus control used in Monitors with high resolution up to 1280 × 1024.

It contains 3 matched R/G/B video Amplifiers with OSD interface and provides flexible interfacing to I²C Bus controlled adjustment systems.

FUNCTIONS

- R/G/B Video Amplifier
- OSD Interface
- I²C BUS Control
- Contrast/OSD Contrast
- Brightness Control
- Cut-Off Brightness Control
- R/G/B SUB Contrast/Cut-Off Control
- Blank/Clamp Gate
- Half tone
- Brightness Uniformity

FEATURES

- 3 - Channel R/G/B Video Amplifier, 150MHz @f-3dB
- I²C Bus Control Items
 - Contrast Control
 - SUB Contrast Control For Each Channel
 - Brightness Control
 - OSD Contrast Control
 - Cut-off Brightness Control
 - Cut-off Control For Each Channel
 - Switch Registers for SBLK and Video Half Tone and Cut-Off INT/EXT
- SUB Contrast Control Range: -11dB
- Capable of 7.0Vpp Output Swing Range
- Video/OSD High Speed Switch
- Clamp Gate With Anti OSD Sagging
- B/U (Brightness Uniformity) Interface
- Video Input Clamp, BRT Clamp
- Video & OSD Half Tone Function on OSD Picture
(OSD Raster Selection by HS1, 2: 4 colors)
- OSD Interface, OSD BLK
- ABL
- TTL R/G/B OSD Inputs, 80MHz bandwidth
- Contrast Control Range: -38dB
- OSD Contrast Control Range: -38dB

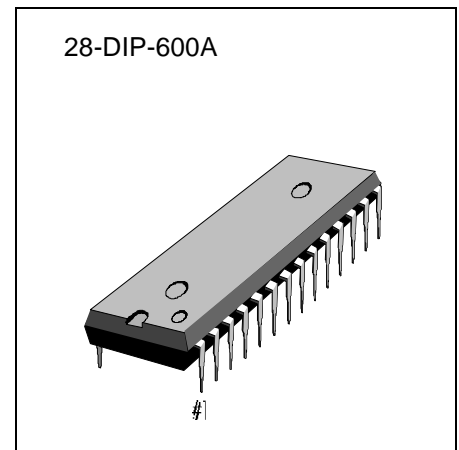

ORDERING INFORMATION

Device	Package	Operating Temperature
KA2500	28-DIP-600A	-20 °C ~ +75 °C

BLOCK DIAGRAM

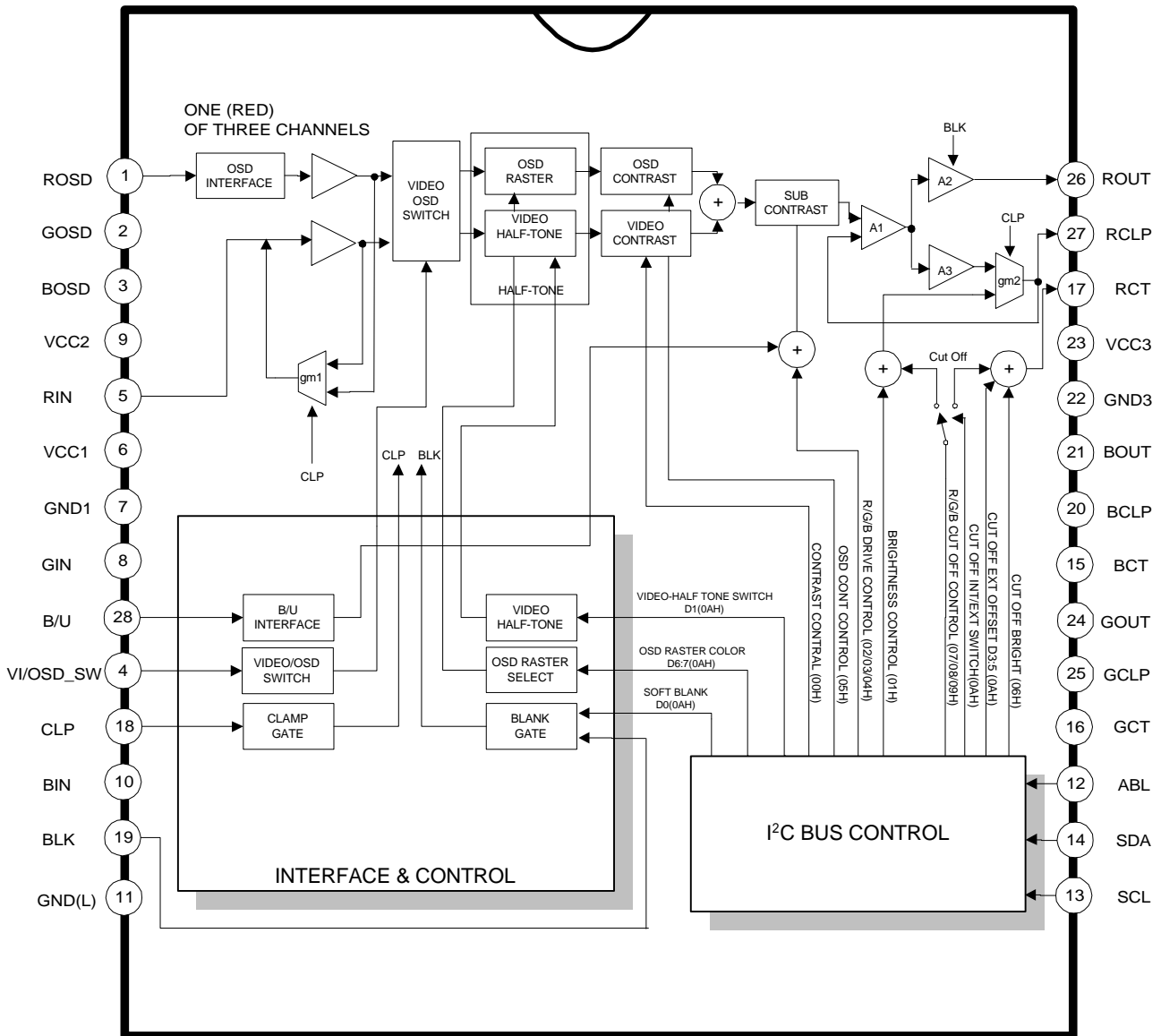

PIN CONFIGURATION

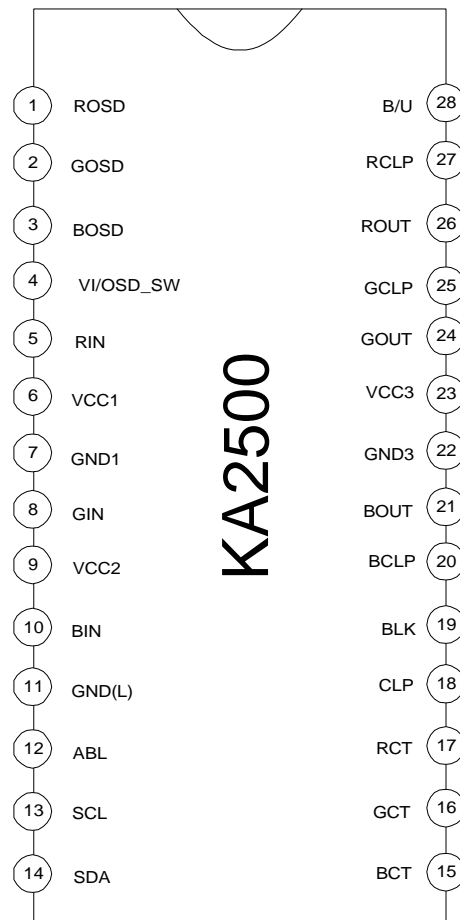

Table 1. Pin Configuration

Pin No	Symbol	I/O	Configuration
1	ROSD	I	Red OSD Input
2	GOSD	I	Green OSD Input
3	BOSD	I	Blue OSD Input
4	VI/OSD_SW	I	Video or OSD Switch
5	RIN	I	Red Video Input
6	V _{CC1}	-	V _{CC} (normal)
7	GND1	-	Ground1 (normal)
8	GIN	I	Green Video Input
9	V _{CC2}	-	V _{CC} (normal)

Table 1. Pin Configuration

Pin No	Symbol	I/O	Configuration
10	BIN	I	Blue Video Input
11	GND (L)	-	Ground2 (logic)
12	ABL	-	Automatic Beam Limit
13	SCL	I/O	Serial Clock
14	SDA	I/O	Serial Data
15	BCT	I	Blue Cut Off Control
16	GCT	I	Green Cut Off Control
17	RCT	I	Red Cut Off Control
18	CLP	I	Clamp Gate Signal Input
19	BLK	I	Blank Gate Signal Input
20	BCLP	-	Blue Clamp Cap
21	BOUT	O	Blue Video Output
22	GND3	-	Ground3 (drive part)
23	V _{CC3}	-	V _{CC} (drive part)
24	GOUT	O	Green Video Output
25	GCLP	-	Green Clamp Cap
26	ROUT	O	Red Video Output
27	RCLP	-	Red Clamp Cap
28	B/U	I	Brightness Uniformity

PIN DESCRIPTION

Table 2. Pin Description

Pin No	Pin Name	Schematic	Description
1 2 3	Red OSD Input (ROSD) Green OSD Input (GOSD) Blue OSD Input (BOSD)		OSD input signals are in TTL level and will be connected to ground when switching to video input
4	Video/OSD Switch (VI/OSD_SW)		Video/OSD switch signal is TTL level PIN4 = 'high', OSD input PIN4 = 'Low', video input
5 8 10	Red Video Input (RIN) Green Video Input (GIN) Blue Video Input (BIN)		MAX input video signal is 0.7 Vpp
6	V _{CC1}	-	Supply voltage (except drive part)
9	V _{CC2}	-	Supply voltage (except drive part)

Table 2. Pin Description (Continued)

Pin No	Pin Name	Schematic	Description
7	GND1	-	Ground (analogue)
11	GND2 (GND (L))	-	Ground (logic)
15 16 17	Blue Cut-Off (BCT) Green Cut-Off (GCT) Red Cut-Off (RCT)	<p>The schematic shows a common bus connected to PIN 17. Five current sources are connected to this bus through switches. The current sources are labeled: 0-180uA (Cut-Off BRT), 0-540uA (Cut-Off), 80uA, 160uA, and 320uA (Cut-Off Offset).</p>	Cut-Off Control Output
18	Clamp Gate Input (CLP)	<p>The schematic shows a transistor circuit where the input PIN 18 is connected to the base of a transistor. The circuit includes a 5.1V reference voltage and a VCC supply. The output is connected to the collector of the transistor.</p>	<p>Video amp active when clamp gate signal is in low TTL level.</p> <p>Clamp gate Min. pulse width : 0.2us, at fh: 50KHz</p>
19	Blank Gate Input (BLK)	<p>The schematic shows a transistor circuit where the input PIN 19 is connected to the base of a transistor. The circuit includes a 7V reference voltage and a VCC supply. The output is connected to the collector of the transistor.</p>	<p>Video amp blanks video signal when blank gate signal is in low TTL level.</p>

Table 2. Pin Description (Continued)

Pin No	Pin Name	Schematic	Description
26 24 21	Red Video Output (ROUT) Green Video Output (GOUT) Blue Video Output (BOUT)		Video signal output
20 25 27	Blue Clamp Cap (BCLP) Green Clamp Cap (GCLP) Red Clamp Cap (RCLP)		Brightness control activated by charging and discharging of the external cap. (0.1μF) (During low clamp gate)
22	GND3	-	Ground (drive part)
23	V _{CC3}	-	Supply voltage (drive part)
13 14	SCL SDA		Serial clock input port of I ² C BUS Serial data input port of I ² C BUS

Table 2. Pin Description (Continued)

Pin No	Pin Name	Schematic	Description
28	B/U Input (B/U)		Parabola input via AC coupling cap
12	ABL Input (ABL)		Automatic beam limitation input (Control Range: 0.5 ~ 4.5V)

ABSOLUTE MAXIMUM RATING (TA = 25 °C) ⁽¹⁾**Table 3. Absolute Maximum Rating**

No	Item	Symbol	Value			Unit
			Min	Typ	Max	
1	Maximum Supply Voltage	V _{CC1/2/3/V_{DD}}	-	-	13.2	V
2	Operating Temperature ⁽²⁾	T _{opr}	-20	-	75	°C
3	Storage Temperature	T _{stg}	-65	-	150	°C
4	Operating Supply Voltage	V _{ccop}	11.4	12.0	12.6	V ⁽³⁾
5	Power Dissipation	P _D	-	-	2.0	W

THERMAL & ESD PARAMETER**Table 4. Thermal & ESD Parameter**

No	Item	Symbol	Value			Unit
			Min	Typ	Max	
1	Thermal Resistance (Junction-ambient)	θ _{ja}	-	46	-	°C/W
2	Junction Temperature	T _j	-	150	-	°C
3	Human Body Mode (C = 100p, R = 1.5k)	HBM	2	-	-	KV
4	Machine Model (C = 200p, R = 0)	MM	300	-	-	V
5	Charge Device Model	CDM	800	-	-	V

ELECTRICAL CHARACTERISTICS**DC Electrical Characteristics**

T_a = 25 °C, V_{CC1} = V_{CC2} = V_{CC3} = 12V; V₄ = 0V; unless otherwise stated

Table 5. DC Electrical Characteristics

Parameter	Symbol	Min	Typ	Max	Unit
Supply Current	I _{CC} ⁽⁴⁾	85	110	135	mA
Clamp Gate Low Input Voltage	V _{15l}	0.8	1.5	3.0	V
Clamp Gate High Input Voltage	V _{15h}	0.8	1.5	2.0	V

Table 5. DC Electrical Characteristics (Continued)

Parameter	Symbol	Min	Typ	Max	Unit
Clamp Gate Low Input Current	I_{15l}	-5.0	-2.0	-	μA
Clamp Gate High Input Current	I_{15h}	-	0.01	1.0	μA
Blank Gate Low Input Voltage	V_{16l}	0.8	1.5	3.0	V
Blank Gate High Input Voltage	V_{16h}	0.8	1.5	2.0	V
Blank Gate Low Input Current	I_{16l}	-5.0	-2.0	-	μA
Blank Gate High Input Current	I_{16h}	-	0.01	1.0	μA
Video Input bias Voltage	V_{bias}	1.6	1.9	2.2	V
Output Clamp Cap Charge Current	$I_{\text{clamp+}}$	0.45	0.75	1.10	mA
Output Clamp Cap Discharge Current	$I_{\text{clamp-}}$	-1.10	-0.75	-0.45	mA
Video Output Low Voltage	V_{OL}	-	100	200	mV
Video Output High Voltage	V_{OH}	6.2	7.5	9.0	V
Video Black Level Output Voltage (POR)	V_{OBL}	1.9	2.2	2.5	V
Video Δ Black Level Output Voltage	$\Delta V_{\text{OBL}}^{(5)}$	-0.3	-	0.3	V
Video Output Blanked Voltage	V_{OB}	-	0.1	0.2	V
Contrast/Drive Control Input Current	$I_{\text{osd}}, I_{\text{drive}}$ I_{con}	-	0.25	1	μA
Spot Killer Voltage	V_{spot}	9.2	10.4	11.2	V

AC Electrical Characteristics

T_a = 25 °C, V_{CC1} = V_{CC2} = V_{CC3} = 12V; V₄ = 0V.

V_{in} = 0.56V_{pp} Manually adjust Video Output pins 21, 24 and 26 to 4V DC for the AC test ⁽¹¹⁾ unless otherwise stated⁽¹²⁾

Table 6. AC Electrical Characteristics

Parameter	Symbol	Min	Typ	Max	Unit
Video Amplifier Gain	A _V max	15.5	17.5	19.5	dB
Contrast Attenuation 1	A _{vc1}	-4.5	-6.0	-7.5	dB
Contrast Attenuation 2	A _{vc2}	-	-38	-35	dB
Drive Attenuation1	A _{vd1}	-3	-4	-5	dB
Drive Attenuation 2	A _{vd2}	-11	-8	-5	dB
Absolute Gain Match	A _V match ⁽⁶⁾	-1	-	1	dB
Gain Change between Amplifiers	A _V track ⁽⁷⁾	-1	-	1	dB
Video Amplifier Distortion	THD	-	1	5	%
Video Amp Bandwidth ^(7,8)	f (-3dB)	130	150	-	MHz
Video Output Rise Time ⁽⁷⁾	t _r (Video)	-	2.3	2.8	ns
Video Output Fall Time ⁽⁷⁾	t _f (Video)	-	3.2	4.0	ns
Video Amplifier 10kHz Isolation	V _{iso_10K} ⁽⁹⁾	-	-65	-45	dB
Video Amplifier 10MHz Isolation	V _{iso_10M} ^(7,9)	-	-50	-35	dB
Blank Output Rise Time ⁽⁷⁾	t _r (Blank)	-	6	15	ns
Blank Output Fall Time ⁽⁷⁾	t _f (Blank)	-	10	30	ns
End of Blanking Propagation Delay	t _{r-prop} (Blank)	-	23	50	ns
Start of Blanking Propagation Delay	t _{f-prop} (Blank)	-	20	45	ns

OSD Electrical Characteristics

T_a = 25 °C, V_{CC1} = V_{CC2} = V_{CC3} = 12V; V₁₉ = 4V; V₁₂ = V₂₈ = 0V;

V₁ = V₂ = V₃ = 4V; V₄ = 4V; unless otherwise stated

Table 7. OSD Electrical Characteristics

Parameter	Symbol	Min	Typ	Max	Unit
OSD Input Low Input Voltage	V _{OSDI}	0.4	1.3	3.0	V

Table 7. OSD Electrical Characteristics (Continued)

Parameter	Symbol	Min	Typ	Max	Unit
OSD Input High Input Voltage	V_{OSDh}	0.4	0.8	1.2	V
OSD Select Low Input Voltage	V_{4l}	0.8	1.6	3.0	V
OSD Select High Input Voltage	V_{4h}	0.8	1.6	2.0	V
OSD Select Low Input Current	I_{4l}	-10	-5	-	μ A
OSD Select High Input Current	I_{4h}	70	100	130	μ A
OSD Output Black Level	$V_{BLV-OSD}$	-	0.1	0.2	V
OSD Output Voltage	V_{OSD}	2.6	3.6	4.6	V_{PP}
OSD Output Vpp Attenuation	V_{OSD_ATT}	30	50	70	%
Output Match between Channels	V_{OSD}	-7	-	7	%
Video to OSD Switch Time ⁽⁷⁾	t_r (OSD S)	-	4	10	ns
OSD to Video Switch Time ⁽⁷⁾	t_f (OSD S)	-	11	20	ns
Video to OSD Propagation Delay	t_{r-pr} (OSD S)	-	11	25	ns
OSD to Video Propagation Delay	t_{f-pr} (OSD S)	-	12	25	ns
OSD Rising Time	t_r (OSD)	-	4	8	ns
OSD Falling Time	t_f (OSD)	-	5	10	ns
OSD Rising Propagation Delay	t_{r-pr} (OSD)	-	7	15	ns
OSD Falling Propagation Delay	t_{f-pr} (OSD)	-	9	20	ns
Video/OSD 10kHz Isolation	liso10K (OSD)	-	-60	-40	dB
Video/OSD 10MHz Isolation	liso10M (OSD)	-	-50	-35	dB

I²C BUS Recommended Operating Conditions

Table 8. I²C BUS Recommended Operating Conditions

Parameter	Symbol	Min	Typ	Max	Unit
Input High Level Voltage	V _{inH}	3.0	-	-	V
Input Low Level Voltage	V _{inL}	-	-	1.5	V
SCL Clock Frequency	f _{SCL}	-	-	200	kHz
Hold Time Before a new transmission can start	t _{BUF}	1.3	-	-	uS
Hold Time for Start Condition	t _{HDS}	0.6	-	-	uS
Set-up Time for Stop Conditions	t _{SUP}	0.6	-	-	uS
The Low Period of SCL	t _{LOW}	1.3	-	-	uS
The High Period of SCL	t _{HIGH}	0.6	-	-	uS
Hold Time Data	t _{HDAT}	0.3	-	-	uS
Set-up Time Data	t _{SUPDAT}	0.25	-	-	uS
Rise Time of SCL	t _R	-	-	1.0	uS
Fall Time of SCL	t _F	-	-	3.0	uS

I²C BUS Timing Requirement

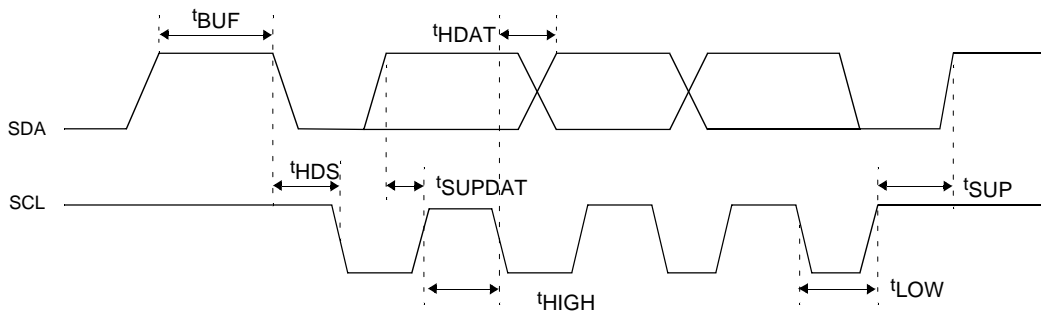

NOTES;

1. Absolute Maximum Rating Indicates the limit beyond which damage to the device may occur.
2. Operating Ratings indicate conditions for which the device is functional but do not guarantee specific performance limits. For guaranteed specifications and test conditions, See the Electrical Characteristics. The guaranteed specifications apply only for the test conditions listed. Some performance characteristics may degrade when the device is not operated under the listed test conditions.
3. V_{CC} supply pins 6, 9, and 23 must be externally wired together to prevent internal damage during V_{CC} power on/off cycles.
4. The supply current specified is the quiescent current for V_{CC1}/V_{CC2} and V_{CC3} with R_L = ∞ . The supply current for V_{CC3} (pin 23) also depends on the output load.
5. Output voltage is dependent on load resistor. Test circuit uses R_L = 390Ω
6. Measure gain difference between any two amplifiers V_{in} = 560mV_{pp}.
7. When measuring video amplifier bandwidth or pulse rise and fall times, a double sided full ground plane printed circuit board without socket is recommended. Video amplifier 10MHz isolation test also requires this printed circuit board. The reason for a double sided full ground plane PCB is that large measurement variations occur in single sided PCBs.
8. Adjust input frequency from 10MHz (AV max reference level) to the -3dB frequency (f_{-3dB}).
9. Measure output levels of the other two undriven amplifiers relative to the driven amplifier to determine channel separation. Terminate the undriven amplifier inputs to simulate generator loading. Repeat test at f_{in} = 10MHz for Iso_10MHz.
10. A minimum pulse width of 200 ns is guaranteed for a horizontal line of 15kHz. This limit is guaranteed by design. if a lower line rate is used a longer clamp pulse may be required.
11. During the AC test the 4V DC level is the center voltage of the AC output signal. For example. if the output is 4V_{pp} the signal will swing between 2V DC and 6V DC.
12. These parameters are not tested on each product which is controlled by an internal qualification procedure.

FUNCTIONAL DESCRIPTION

Contrast (OSD Contrast Adjustment) (8-bits)

The contrast adjustment is made by controlling simultaneously the gain of three internal variable gain amplifiers through the I²C bus interface.

The contrast adjustment allows you to cover a typical range of 38dB.

Brightness Adjustment (8-bits)

The brightness adjustment controls to add the same black level (pedestal) to the 3-channel/R/G/B signals after contrast amplifier by I²C BUS.

Cut-Off Brightness Adjustments (8-bits)

The Cut-Off Brightness adjustment is made by simultaneously controlling the external cut-off current.

Cut-Off (SUB Contrast) Adjustment (8-bits + 3)

These adjustments are used to adjust the white balance, and the gain of each channel is controlled by I²C BUS. The SUB contrast adjustment allows you to cover a typical range of 11dB.

OSD Inputs

The KA2500 includes all the circuitry necessary to mix OSD signals into the R/G/B video signal.

You need 4 pins for this function. (R/G/B OSD, OSD blanking)

Serial Interface

The 2-wires serial interface is an I²C BUS interface.

The slave address of the KA2500 is DC (hexadecimal)

Bit8	Bit7	Bit6	Bit5	Bit4	Bit3	Bit2	Bit1
1	1	0	1	1	1	0	0 (W)

Data Transfer

All bytes are sent MSB (Most Significant Bit) bit first and the write data transfer is closed by a stop.

The MCU can write data into the KA2500 registers. To do that, after a start, the MCU must send:

- The I²C address slave byte with a low level for R/W bit (bit1)
- The byte of the internal register address where the MCU wants to write data (SUB Address)
- The data
- Stop

I²C BUS Write Operation

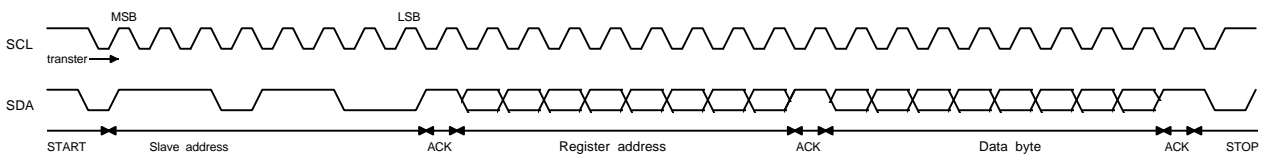

Register Description

Register Sub Address (Slave address: DCH)

Sub Address (Hex)	Register Names	DAC bits	Int. value (Hex)
00	Contrast control	8 bits	80
01	Brightness control (3-ch)	8 bits	80
02	SUB Contrast control (R)	8 bits	80
03	SUB Contrast control (G)	8 bits	80
04	SUB Contrast control (B)	8 bits	80
05	OSD Contrast control	8 bits	80
06	Cut-off Brightness control	8 bits	80
07	Cut-off control (R)	8 bits	80
08	Cut-off control (G)	8 bits	80
09	Cut-off control (B)	8 bits	80
0A	HS2 HS1 CS3 CS2 CS1 CT HT SBLK		20

HT: Video & OSD Half Tone ctrl switch (1: ON, 0: OFF)

HS2/HS1: OSD Raster Color Switch for Video Half Tone (HT = 1)

HS2	HS1	OSDR	OSDG	OSDB	Half Tone
0	0	0	0	0	Black
0	1	0	1	0	Green
1	0	0	0	1	Blue
1	1	0	1	1	Cyan

CT: Cut-off Control INT/EXT (0:INT/1: EXT) select switch (DC/AC mode)

CS1/CS2/CS3/: 80/160/320uA Cut-Off ctrl EXT offset current Switch (CT = 1)

SBLK: Soft Blanking switch (1: ON, 0: OFF)

Contrast Register (SUB ADRS: 00H) (Vin = 0.56Vpp, bright: 40H, subcont: FFH)

Hex	B7	B6	B5	B4	B3	B2	B1	B0	Contrast (Vpp)	Gain (dB)	Int. value (Hex)
00	0	0	0	0	0	0	0	0	0	-30.0	
80	1	0	0	0	0	0	0	0	1.12	11.5	0
FF	1	1	1	1	1	1	1	1	4.2	17.5	
Increment/bit									0.0164		

Brightness Register (3-ch) (SUB ADRS: 01H) (cont: 40H, subcont: FFH)

Hex	B7	B6	B5	B4	B3	B2	B1	B0	Brightness (Vpp)	Int. value (Hex)
00	0	0	0	0	0	0	0	0	0	
80	1	0	0	0	0	0	0	0	2	0
FF	1	1	1	1	1	1	1	1	4	
Increment/bit									0.0156	

SUB Contrast Register (R/G/B-ch) (SUB ADRS: 02/03/04H)

(Vin=0.56Vpp, bright: 40H, cont: FFH)

Hex	B7	B6	B5	B4	B3	B2	B1	B0	SUB Contrast (Vpp)	Gain (dB)	Int. value (Hex)
00	0	0	0	0	0	0	0	0	1.33	7.5	
80	1	0	0	0	0	0	0	0	2.65	13.5	0
FF	1	1	1	1	1	1	1	1	4.2	17.5	
Increment/bit									0.0123		

OSD Contrast Register (SUB ADRS: 05H) (VOSD = TTL, bright: 40H, subcont: FFH)

Hex	B7	B6	B5	B4	B3	B2	B1	B0	OSD Contrast (Vpp)	Gain (dB)	Int. value (Hex)
00	0	0	0	0	0	0	0	0	0	-	
80	1	0	0	0	0	0	0	0	3.7	-	0
FF	1	1	1	1	1	1	1	1	3.5	-	
Increment/bit									0.0289		

Cut-Off Brightness Register (3-ch) (SUB ADRS: 06H)

Hex	B7	B6	B5	B4	B3	B2	B1	B0	Cut-Off Brightness (μ A)	Int. value (Hex)
00	0	0	0	0	0	0	0	0	0	
80	1	0	0	0	0	0	0	0	75	0
FF	1	1	1	1	1	1	1	1	150	
Increment/bit									0.588	

Cut-Off Register (R/G/B-ch) (SUB ADRS: 07/08/09H)**(cont = 80H, subcont: FFH, INT: CT=0, EXT: CT=1)**

Hex	B7	B6	B5	B4	B3	B2	B1	B0	Cut-Off INT (V)	Cut-Off EXT(μ A)	Int. value (Hex)
00	0	0	0	0	0	0	0	0	-0.5	0	
80	1	0	0	0	0	0	0	0	0	250	0
FF	1	1	1	1	1	1	1	1	0.5	500	
Increment/bit									3.9mV	1.96	

APPLICATION CIRCUIT

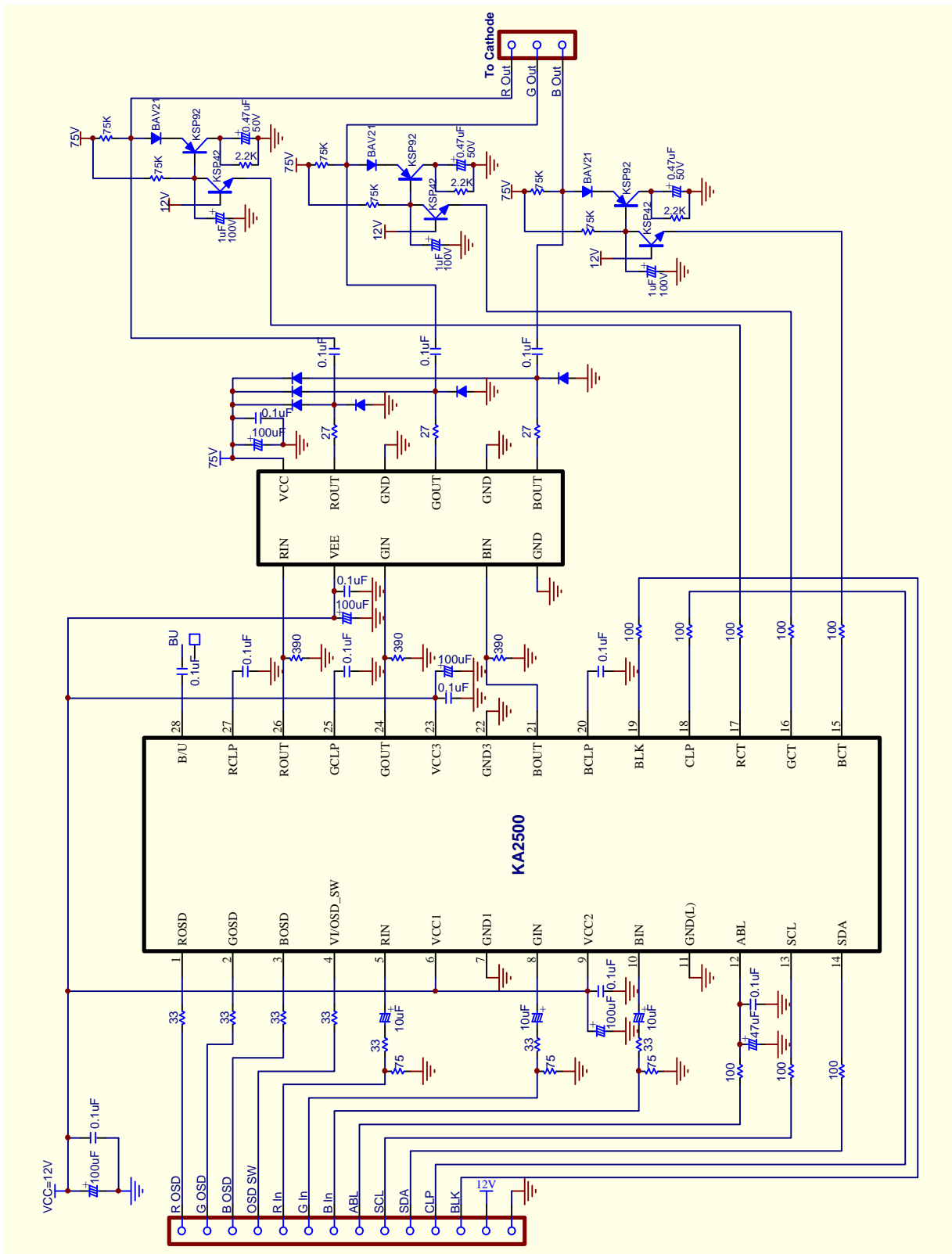

CHARACTERISTICS CURVE

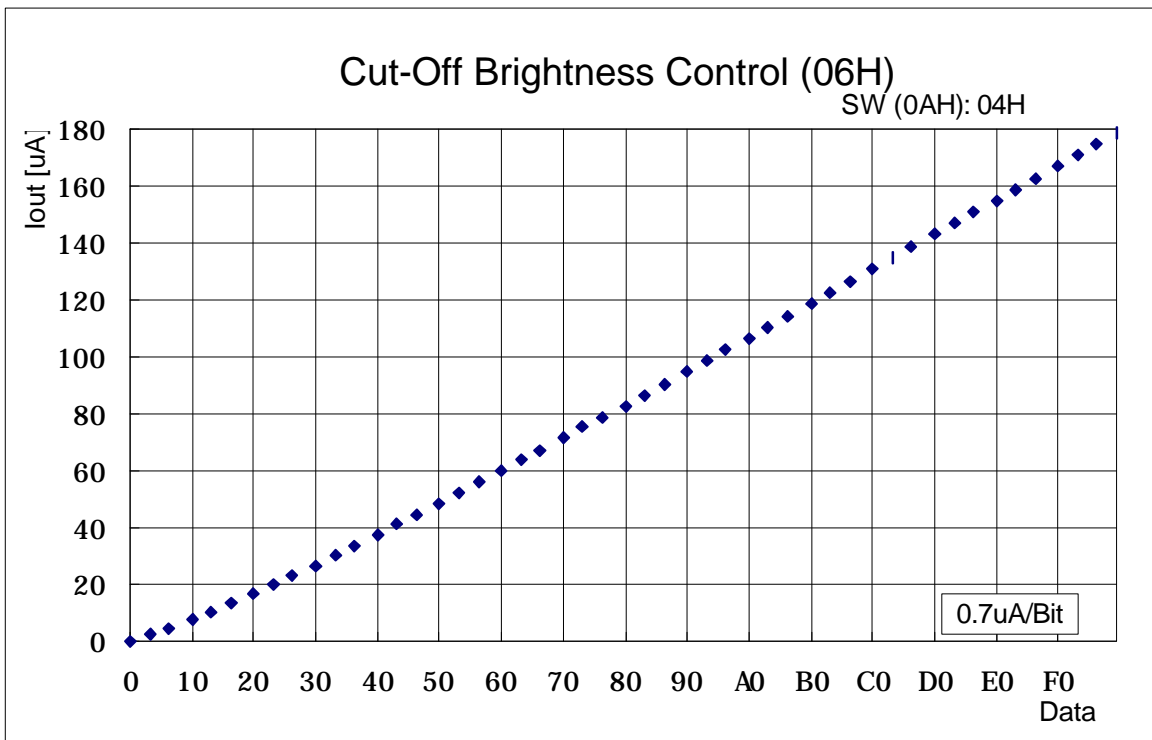
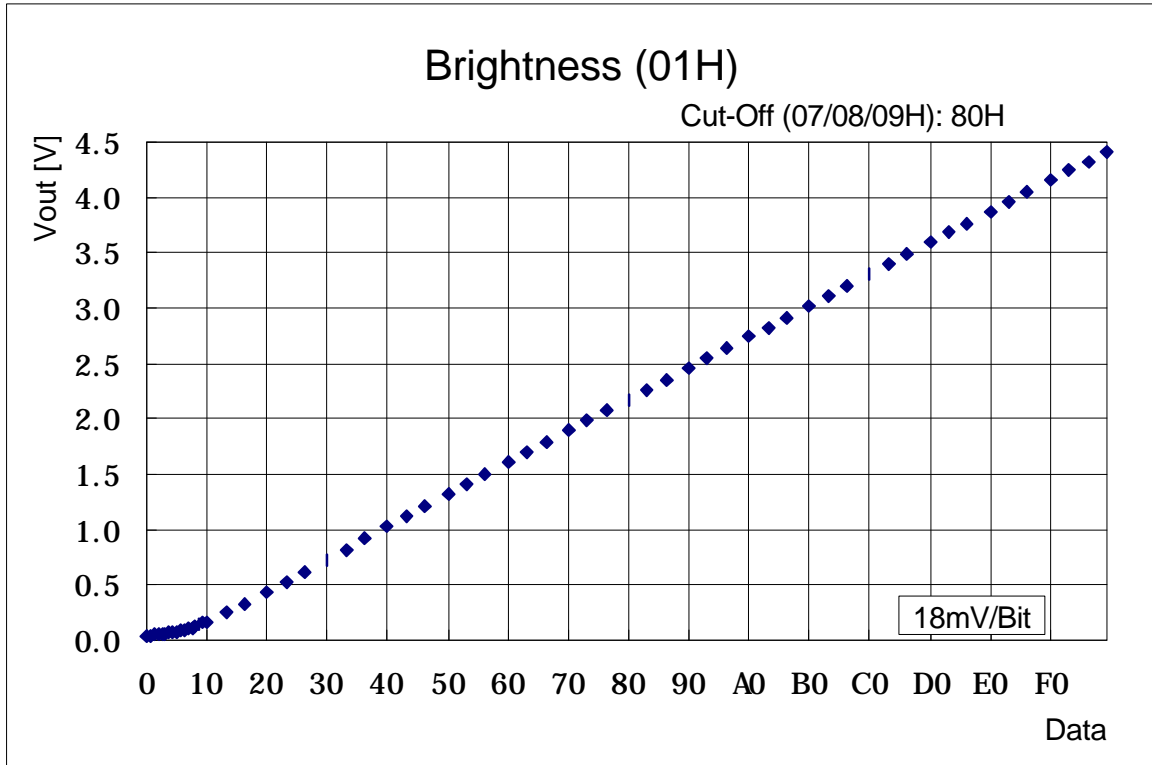

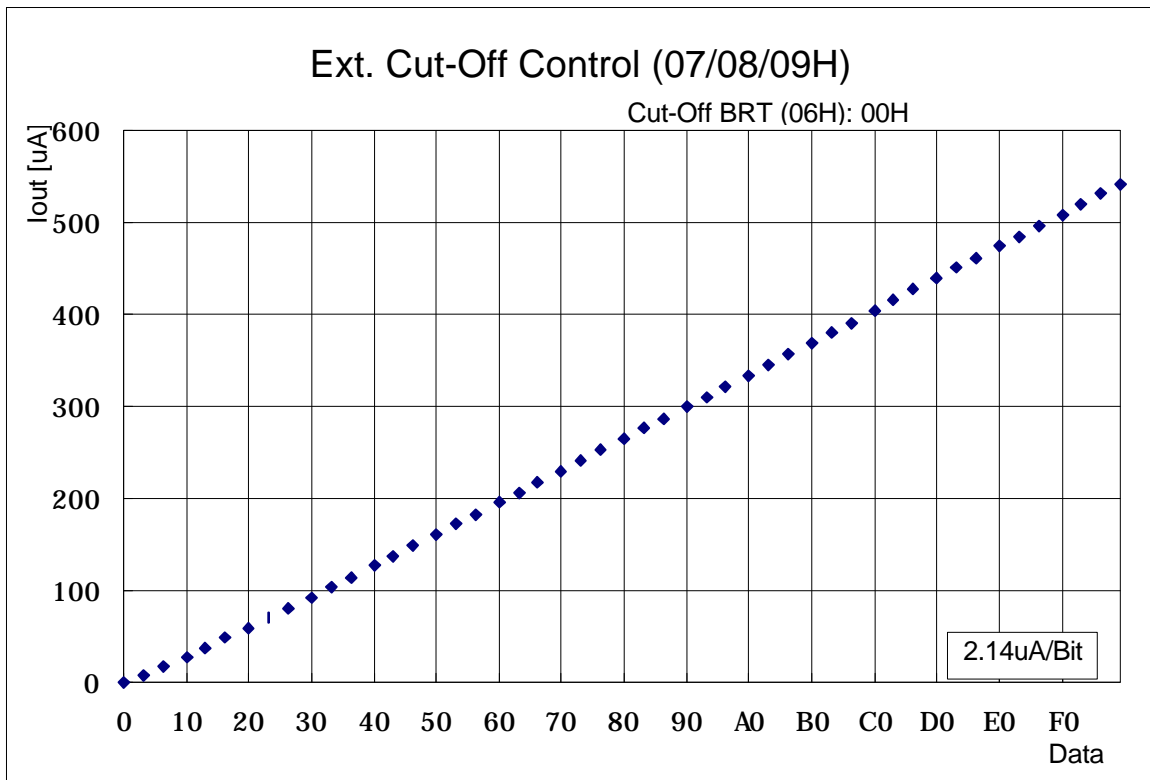
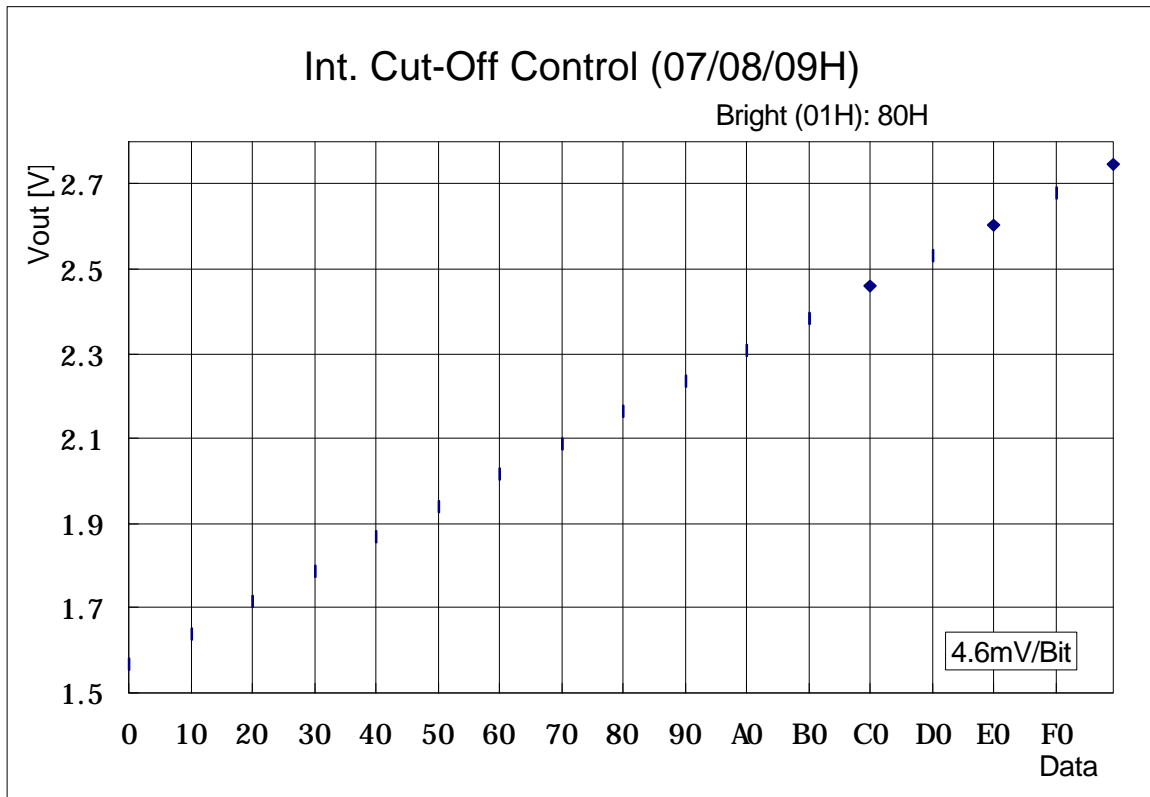

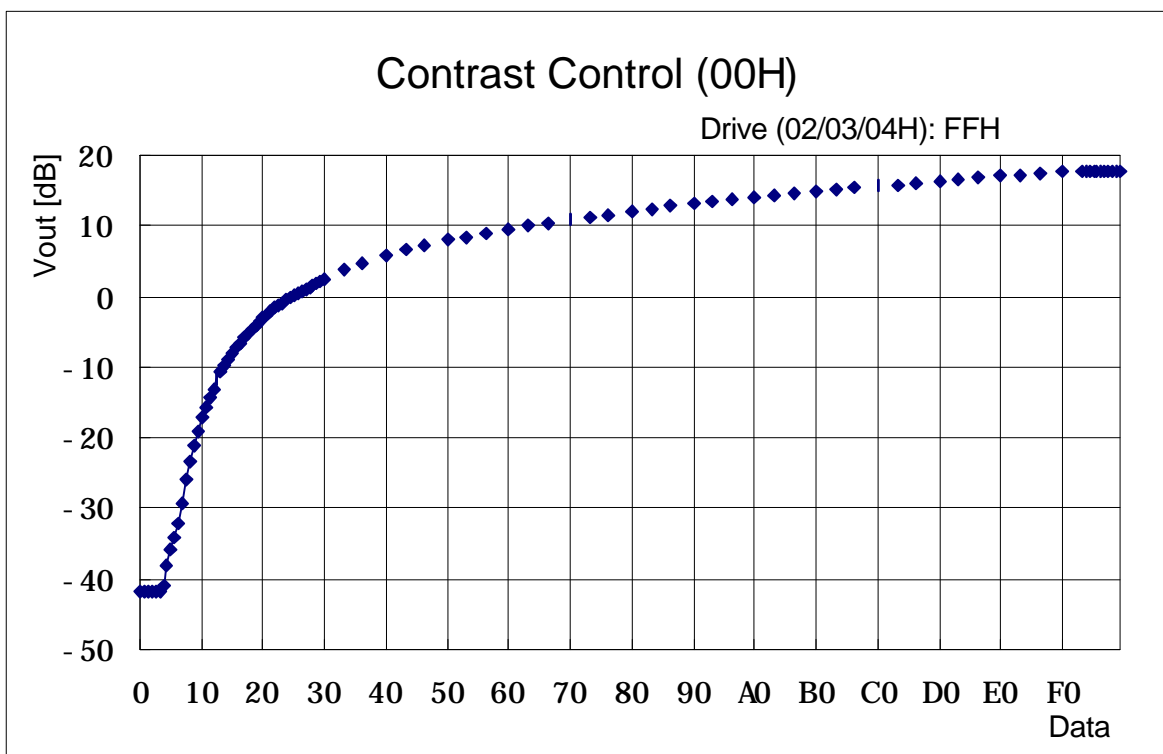
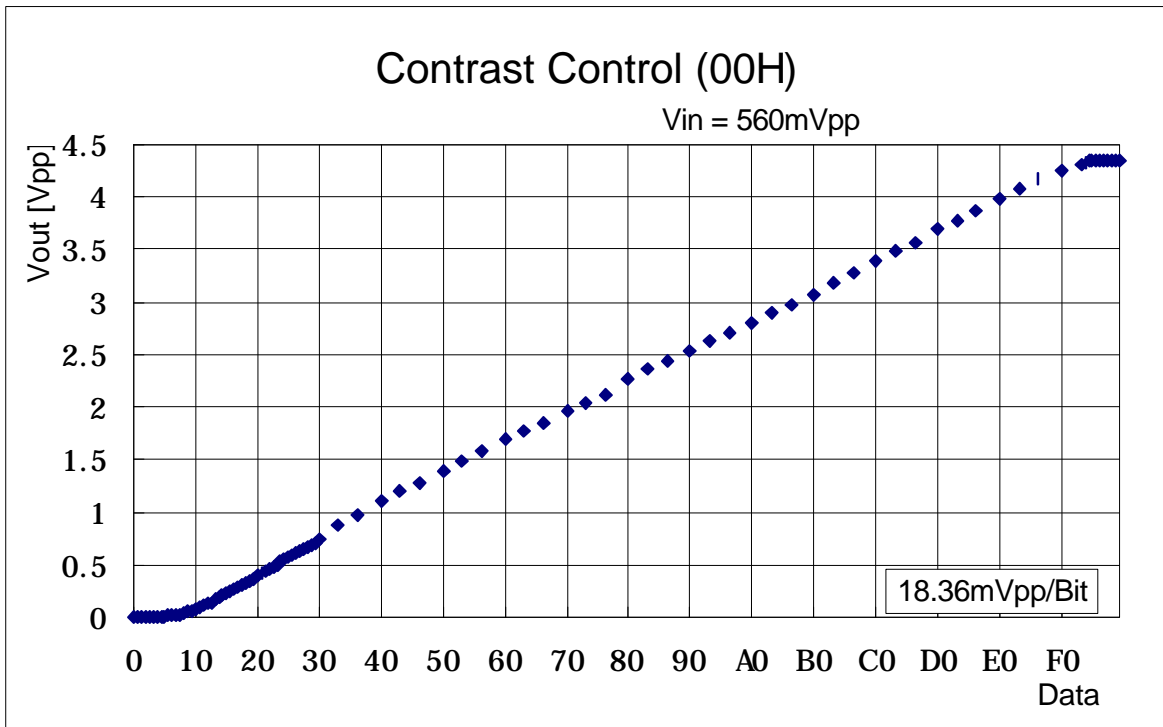

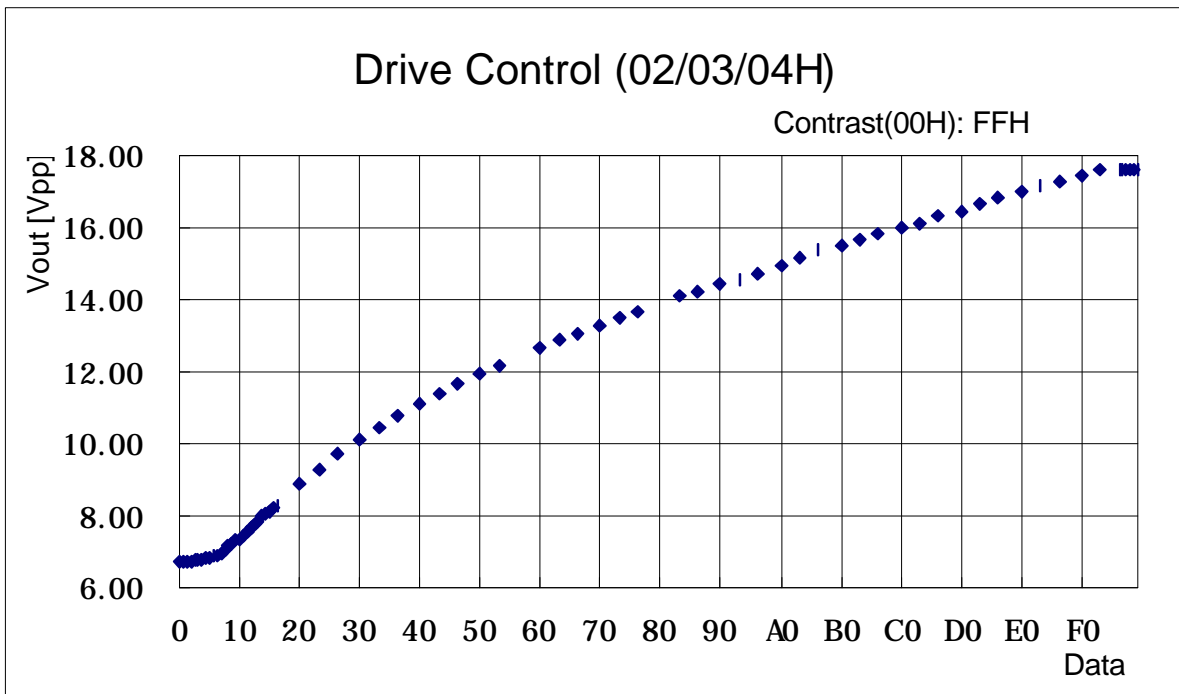
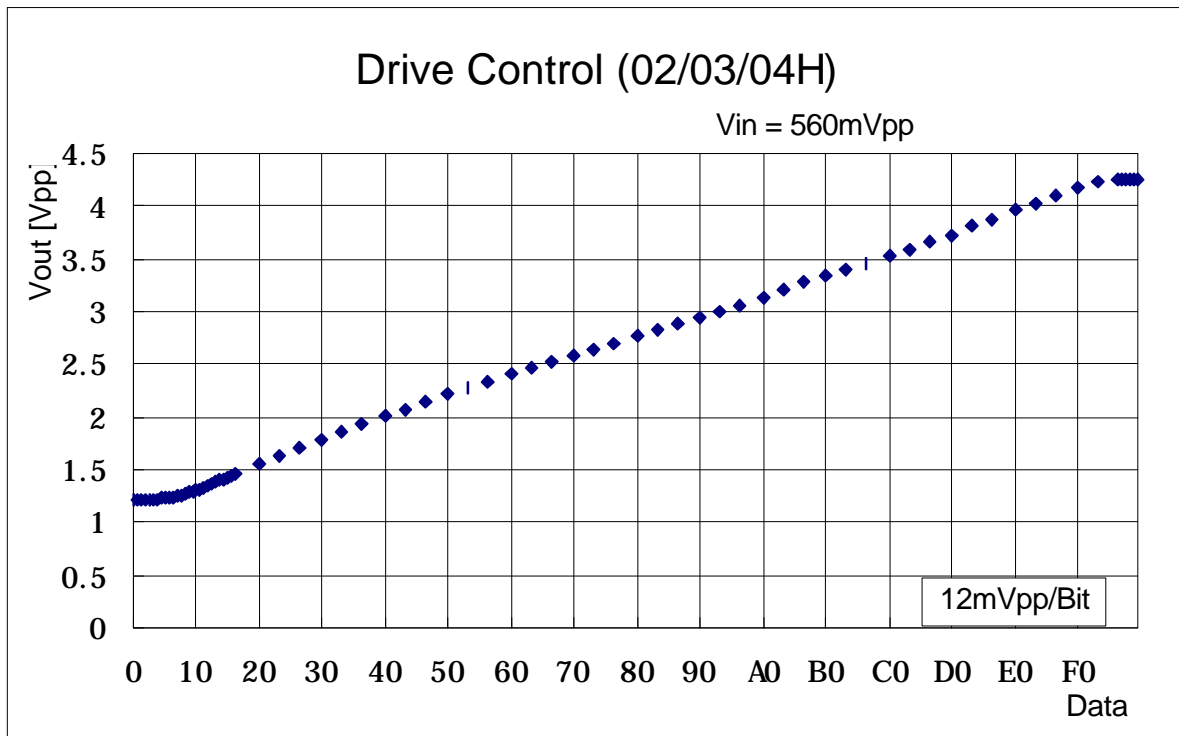

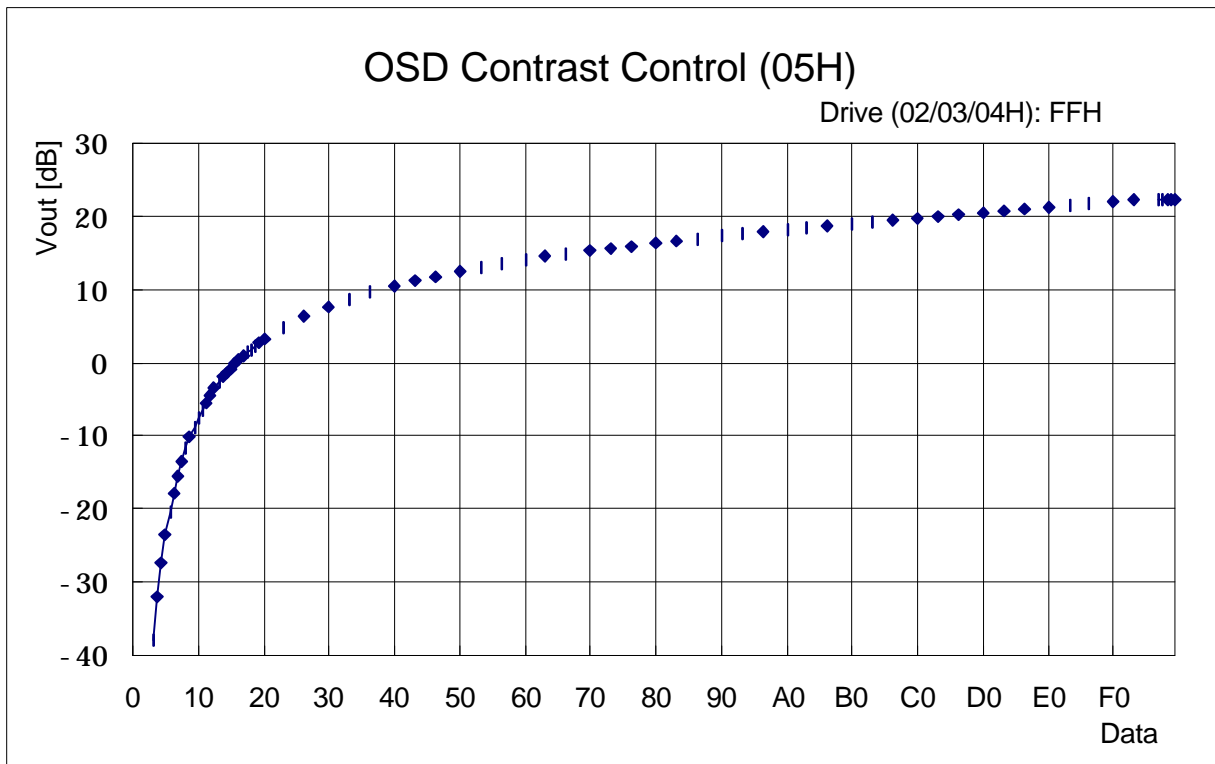
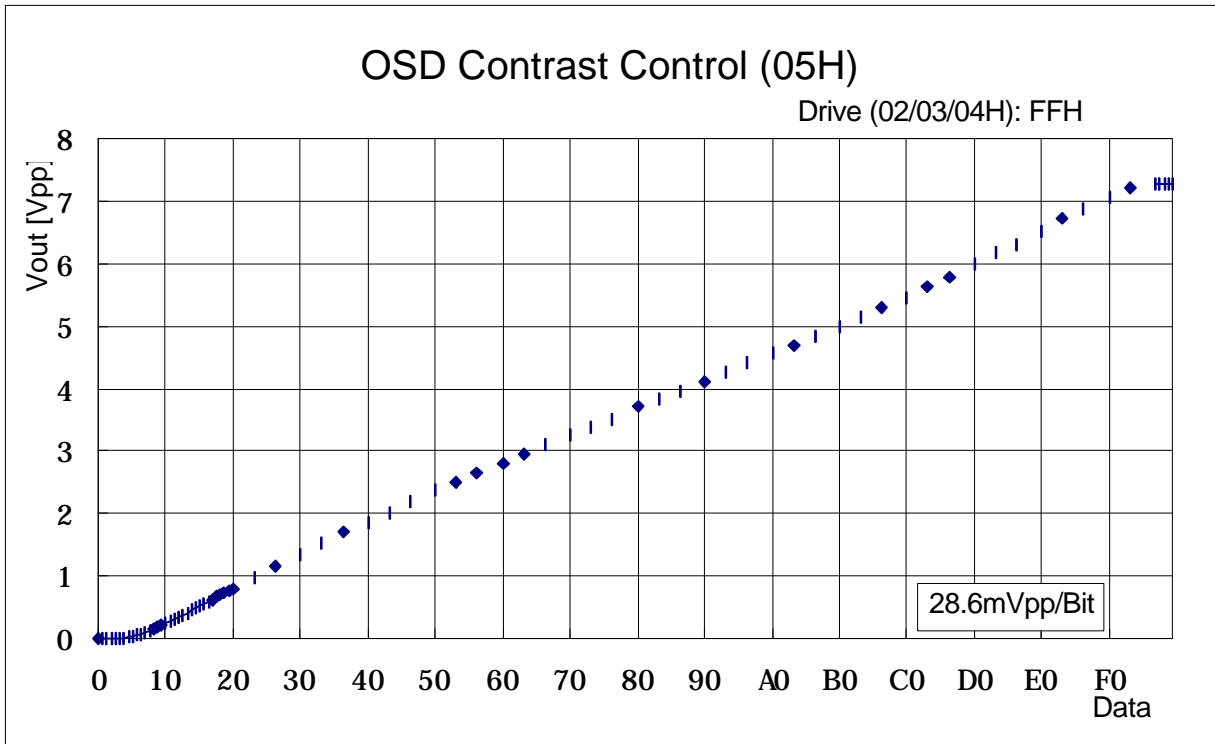

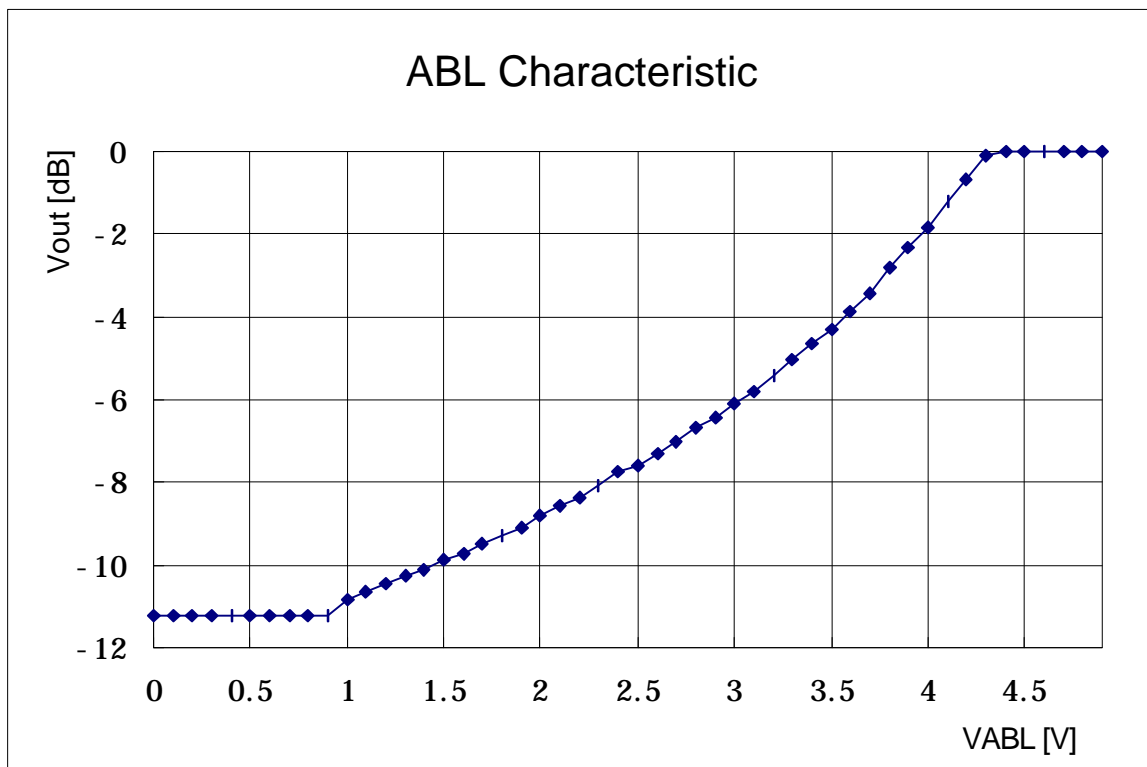
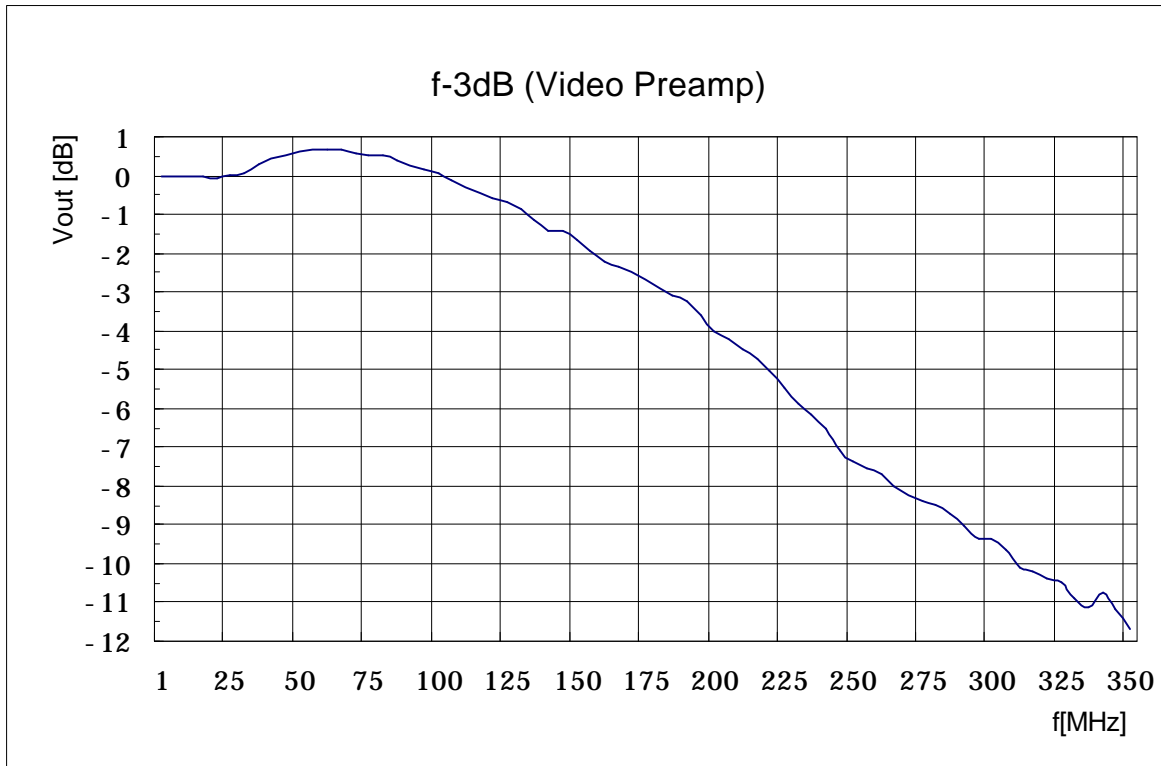

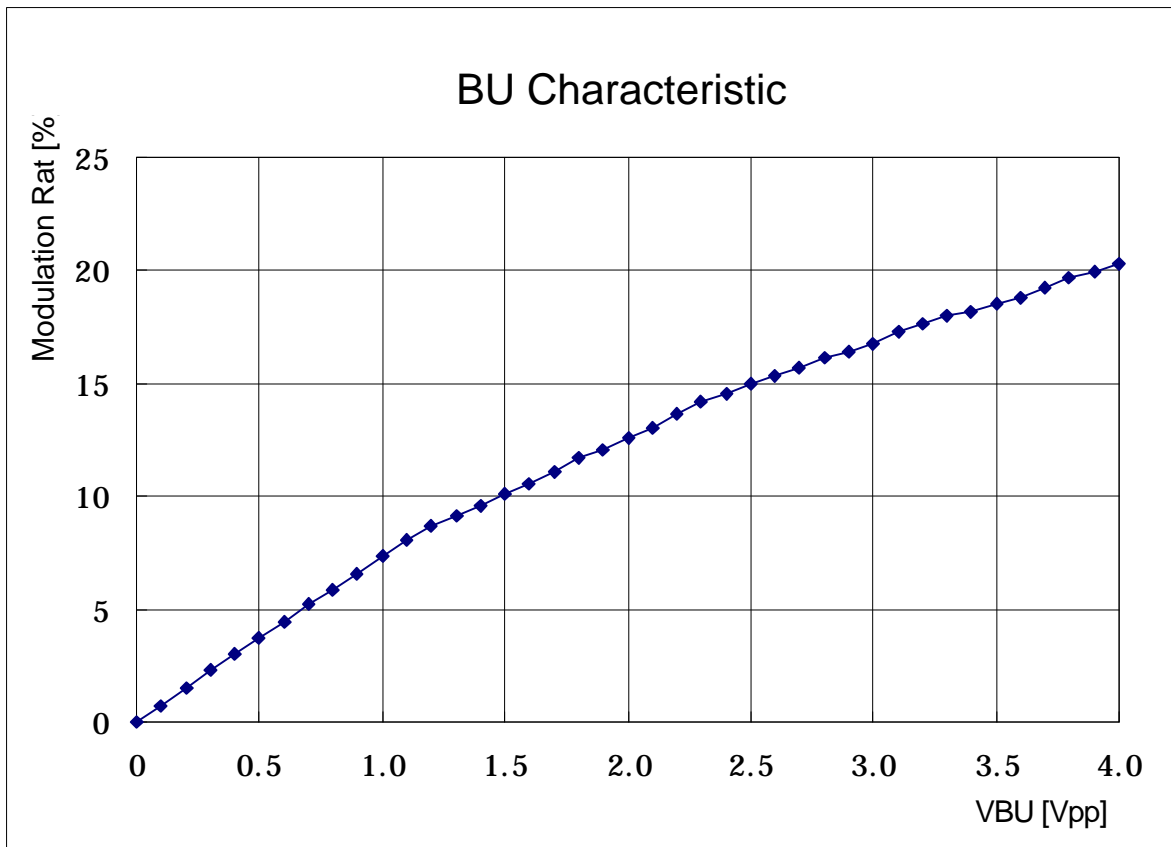



LittleDiode supplies new, hard to find or obsolete electronic components and semiconductors all over the world.

With over two million different components listed you are sure to find the part you need.

Feel free to visit us today at our online store:

LittleDiode.com

Looking forward to providing you with the best possible service.