

90 Degree Hybrid 0.88–0.96 GHz



HY92-12

Features

- Low Cost
- Low Profile
- Small SOIC-8 Package
- Tape & Reel

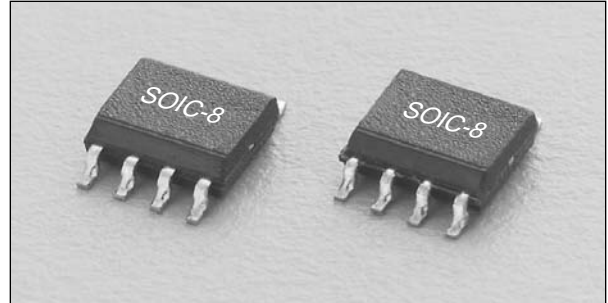

Description

The HY92-12 is a 90 degree hybrid tuned for the 0.88–0.96 GHz band. The monolithic circuitry is 100% passive and offers low loss, high isolation and exceptional phase/amplitude balance. It is available in the SOIC-8 leaded surface mount package.

Electrical Specifications at 25°C

Parameter	Min.	Typ.	Max.	Unit
Frequency	0.88		0.96	GHz
Insertion Loss ¹		.4	.5	dB
Isolation	20	25		dB
VSWR All Ports		1.1:1	1.2:1	
Amplitude Balance		±.5	±.8	dB
Phase Balance		±1.0	±2.0	Deg.

1. Less 3 dB power split.

Pin Out

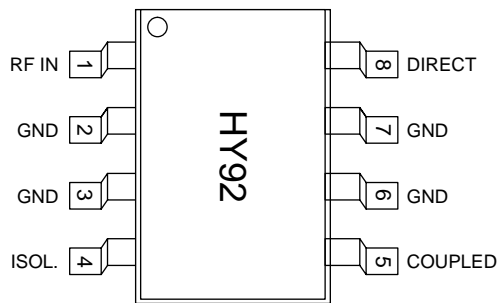

Block Diagram

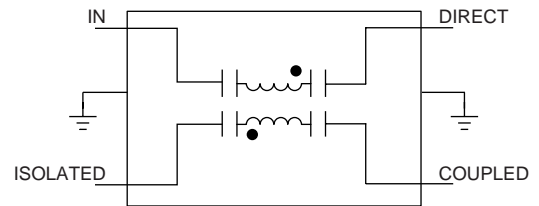

Typical Performance Data

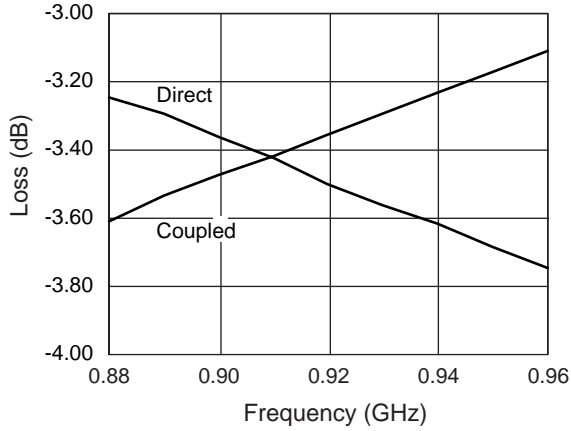

Path Losses vs. Frequency

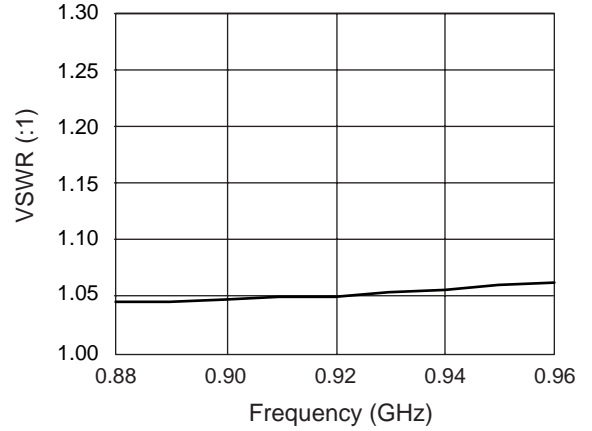

Input VSWR vs. Frequency

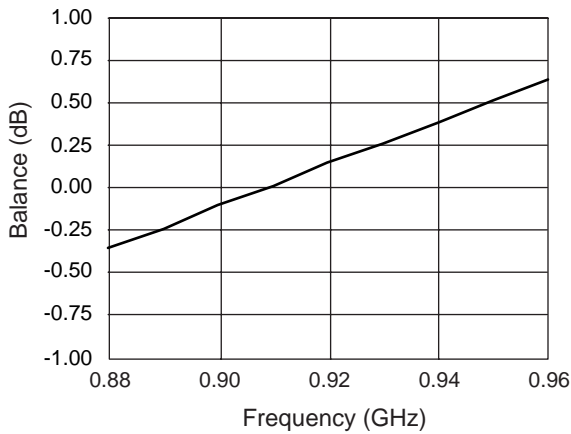

Amplitude Balance vs. Frequency

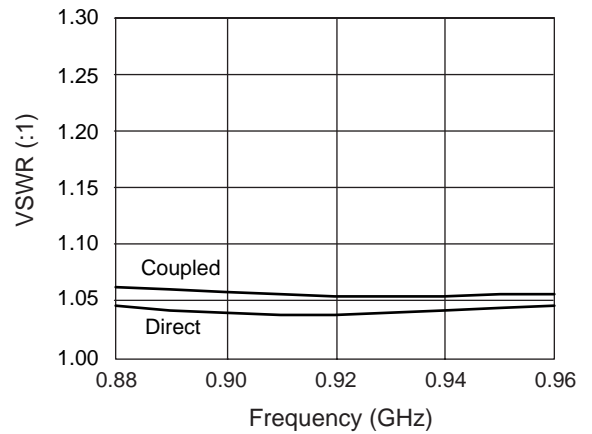

Output VSWR vs. Frequency

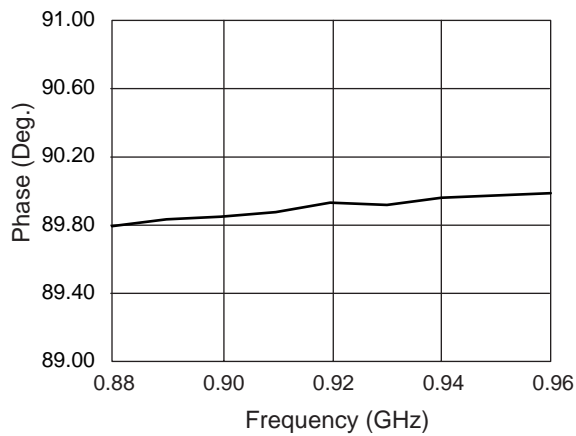

Coupled - Direct Phase vs. Frequency

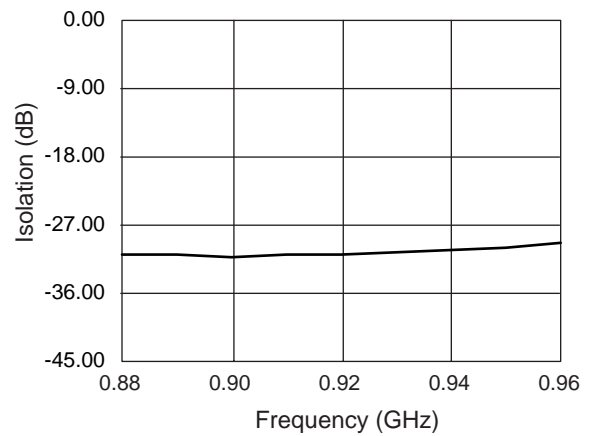

Isolation vs. Frequency

Absolute Maximum Ratings

Characteristic	Value
Input Power ¹	+4 W
Operating Temperature	-40°C to +85°C
Storage Temperature	-65°C to +150°C
Electrostatic Discharge	+125 V

1. Exceeding these parameters may cause irreversible damage.

Recommended Board Layout

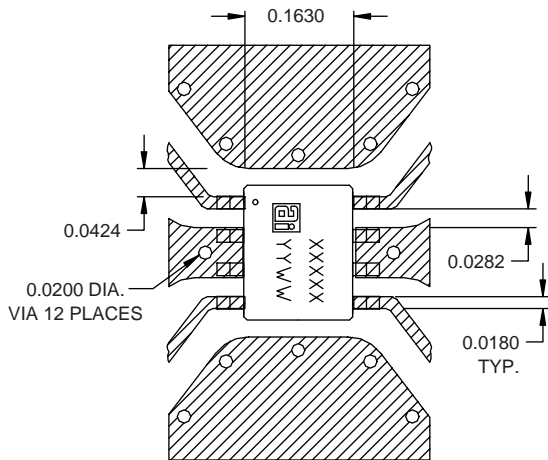

Materials 10 mil FR-4.
Dimensions are in inches.

SOIC-8

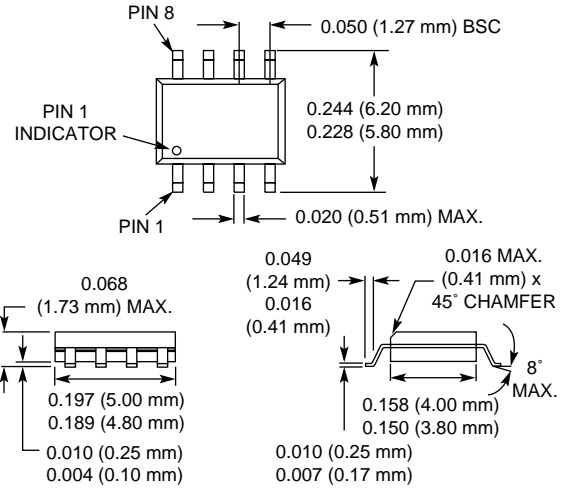



LittleDiode supplies new, hard to find or obsolete electronic components and semiconductors all over the world.

With over two million different components listed you are sure to find the part you need.

Feel free to visit us today at our online store:

LittleDiode.com

Looking forward to providing you with the best possible service.