

Frequency Generator for CD-ROM Systems

General Description

The ICS9120-53 is a high performance frequency generator designed to support digital compact disk drive systems. It offers all clock frequencies required for the servo and decoder sections of these devices. These frequencies are synthesized from a single 16.9344 MHz on-chip oscillator.

High accuracy, low jitter PLLs meet the 150 ppm frequency tolerance required by these systems. Fast output clock edge rates minimize board induced jitter.

Unlike competitive devices, the ICS9120-53 operates over the entire 3.0-5.5V range.

Features

- Generates 33.8688 MHz or 42.83 MHz decode clocks plus the 12 and 24 MHz fixed clocks
- Single 8.4672 MHz crystal or system clock reference
- 200ps one sigma jitter maintains 16-bit performance
- Output rise/fall times less than 2.0ns
- On-chip loop filter components
- 3.3V-5V supply range
- 8-pin, 150-mil SOIC

Applications

- Specifically designed to support the high performance requirements of CD-ROM drive systems

Functionality

X1, X2 (MHz)	FS	Divisor	CLK1
8.4672	0	X12÷3	33.8688
86.4672	1	X61÷6	42.83

Clock	X1, X2 (MHz)	Divisor	Output (MHz)
12M	8.4672	X52÷11÷2	20.0134
24M	8.4672	X52÷11	40.0268

Pin Configuration

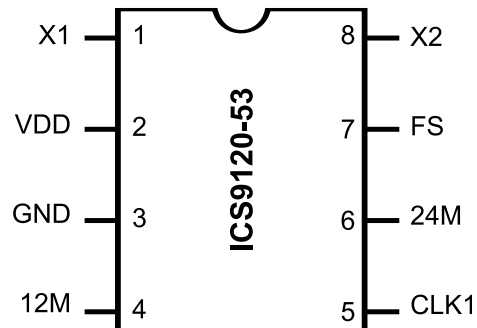

8-Pin SOIC

Block Diagram

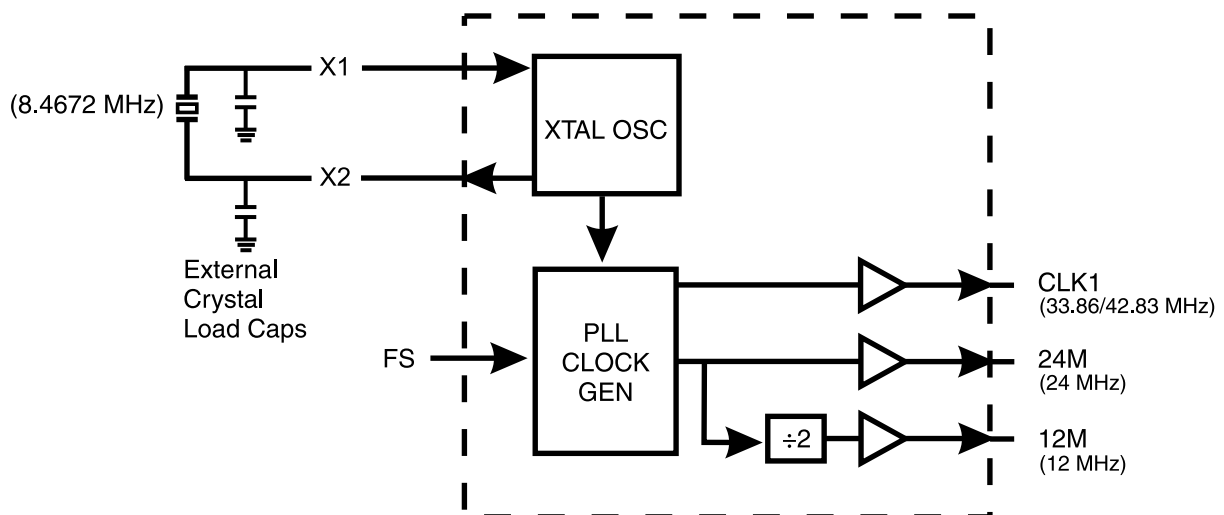

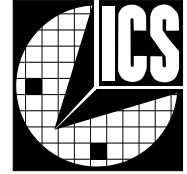

Pin Descriptions

PIN NUMBER	PIN NAME	TYPE	DESCRIPTION
1	X1	Input	Crystal or external clock source. Has feedback bias for crystal.
2	VDD	Power	+Power supply input.
3	GND	Power	Ground return for Pin 2.
4	20M	Output	12 MHz fixed output clock.
5	CLK1	Output	33.8/42.83 MHz selectable clock output.
6	40M	Output	24 MHz fixedoutput clock.
7	FS	Input	Input selector for CLK1.
8	X2	Output	Crystal output drive.

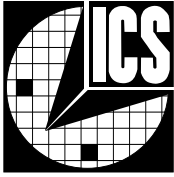

Absolute Maximum Ratings

AVDD, VDD referenced to GND 7V
 Operating temperature under bias 0°C to +70°C
 Storage temperature -65°C to +150°C
 Voltage on I/O pins referenced to GND GND -0.5V to VDD +0.5V
 Power dissipation 0.5 Watts

Stresses above those listed under Absolute Maximum Ratings may cause permanent damage to the device. This is a stress rating only and functional operation of the device at these or any other conditions above those indicated in the operational sections of the specifications is not implied. Exposure to absolute maximum rating conditions for extended periods may affect product reliability.

Electrical Characteristics at 5 V

V_{DD} = +4.5 to +5.5 V, T_A = 0 to 70°C unless otherwise stated

DC Characteristics						
PARAMETER	SYMBOL	TEST CONDITIONS	MIN	TYP	MAX	UNITS
Input Low Voltage	V _{IL}		-	-	0.8	V
Input High Voltage	V _{IH}		2.0	-	-	V
Input Low Current	I _{IL}	V _{IN} =0V	-18.0	-8.3	-	μA
Input High Current	I _{IH}	V _{IN} =V _{DD}	-	-	5.0	μA
Output Low Voltage	V _{OL} *	I _{OL} =+10mA	-	0.15	0.4	V
Output High Voltage	V _{OH} *	I _{OH} =-30mA	2.4	3.7	-	V
Output Low Current	I _{OL} *	V _{OL} =0.8V	25.0	45.0	-	mA
Output High Current	I _{OH} *	V _{OH} =2.4V	-	-53.0	-35.0	mA
Supply Current	I _{DD}	Unloaded	-	24.0	50.0	mA
Pull-up Resistor Value	R _{PU} *		-	400.0	800.0	k ohm
AC Characteristics						
Rise Time	T _r *	15pF load, 0.8 to 2.0V	-	0.9	2.0	ns
Fall Time	T _f *	15pF load, 2.0 to 0.8V	-	0.7	1.5	ns
Rise Time	T _r *	15pF load, 20% to 80%	-	1.8	3.25	ns
Fall Time	T _f *	15pF load, 80% to 20%	-	1.4	2.5	ns
Duty Cycle	D _t *	15pF load @ 50% of V _{DD}	45.0	50.0	55.0	%
Jitter, One Sigma	T _{jis} *	For all frequencies	-	100.0	200.0	ps
Jitter, Absolute	T _{jab} *	For all frequencies	-500.0	300.0	500.0	ps
Jitter, One Sigma	T _{jis} *	REFCLK only	-	266.0	450.0	ps
Jitter, Absolute	T _{jab} *	REFCLK only	-1200	750.0	1200	ps
Input Frequency Range	F _i *		8.0	8.4	10.0	MHz
Output Frequency Range	F _o *		11.0	-	42.0	MHz
Output Mean Frequency Accuracy vs. Target	F _{oa} *	With 8.4672 MHz input	-0.125	-	-0.04	%
Power-up Time	T _{pu} *	0 to 33.8 MHz	-	5.5	12.0	ms
Crystal Input Capacitance	C _{inx} *	X1 (Pin 1), X2 (Pin 8)	-5	5	-	pF

*Parameter is guaranteed by design and characterization. Not 100% tested in production.

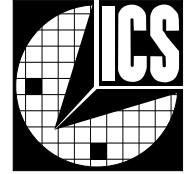

Electrical Characteristics at 3.3 V

$V_{DD} = +3.0$ to $+3.7V$, $T_A = 0^{\circ}C$ - $70^{\circ}C$ unless otherwise stated

DC Characteristics						
PARAMETER	SYMBOL	TEST CONDITIONS	MIN	TYP	MAX	UNITS
Input Low Voltage	V_{IL}		-	-	$0.2V_{DD}$	V
Input High Voltage	V_{IH}		$0.7V_{DD}$	-	-	V
Input Low Current	I_{IL}	$V_{IN}=0V$	-8.0	-3.6	-	μA
Input High Current	I_{IH}	$V_{IN}=V_{DD}$	-	-	5.0	μA
Output Low Voltage	V_{OL}^*	$I_{OL}=6.0mA$	-	$0.05V_{DD}$	0.1	V
Output High Voltage	V_{OH}^*	$I_{OH}=4.0mA$	$0.85V_{DD}$	$0.94V_{DD}$	-	V
Output Low Current	I_{OL}^*	$V_{OL}=0.2V_{DD}$	15.0	24.0	-	mA
Output High Current	I_{OH}^*	$V_{OH}=0.7V_{DD}$	-	-13.0	-8.0	mA
Supply Current	I_{DD}	Unloaded	-	16.0	40.0	mA
Pull-up Resistor Value	R_{PU}^*		-	620.0	900.0	k ohm
AC Characteristics						
Rise Time	T_r^*	15pF load 0.8 to 2.0V	-	1.5	4.0	ns
Fall Time	T_f^*	15pF load 2.0 to 0.8V	-	1.0	3.0	ns
Rise Time	T_r^*	15pF load 20% to 80%	-	2.2	4.0	ns
Fall Time	T_f^*	15pF load 80% to 20%	-	1.5	3.0	ns
Duty Cycle	D_t^*	15pF load @ 50% of V_{DD}	45.0	50.0	55.0	%
Jitter, One Sigma	T_{jis}^*	For all frequencies	-	150.0	200	ps
Jitter Absolute	T_{jab}^*	For all frequencies	-550.0	330.0	550.0	ps
Input Frequency Range	F_i^*		8.0	8.4	10.0	MHz
Output Frequency Range	F_o^*		11.0	-	38.0	MHz
Output Mean Frequency Accuracy vs. Target	F_{oa}^*	With 8.4672 MHz input	-0.125	-	-0.04	%
Power-up Time	T_{pu}^*	0 to 33.8 MHz	-	5.5	12.0	ms
Crystal Input Capacitance	C_{inx}^*	X1 (Pin 1), X2 (Pin 8)	-	5	-	pF

*Parameter is guaranteed by design and characterization. Not 100% tested in production.

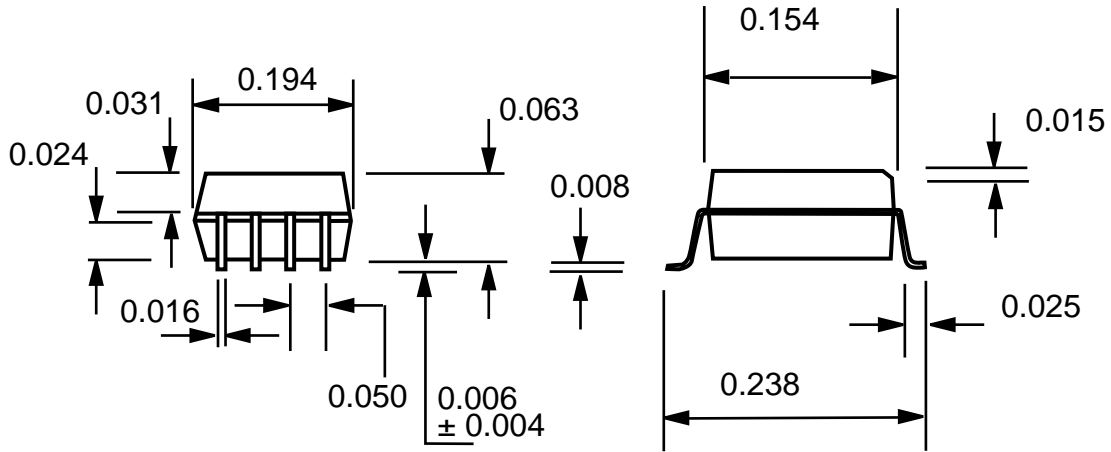
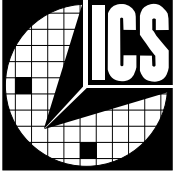

8-Pin SOIC Package

Ordering Information

ICS9120M-53

Example:

ICS XXXX M-PPP

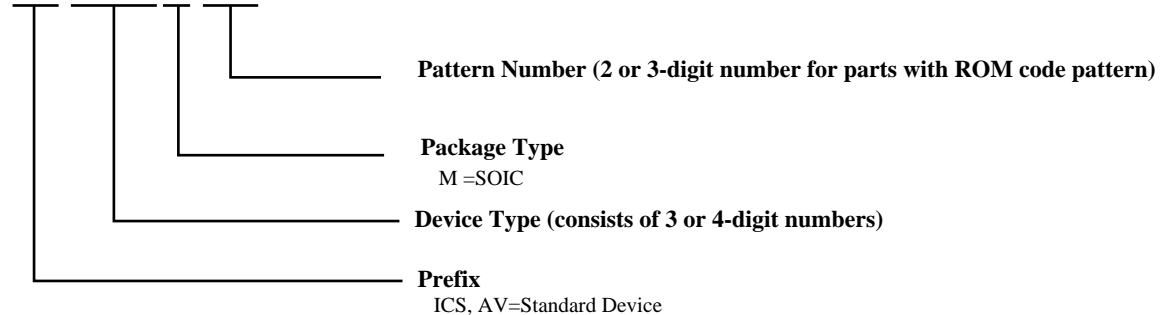



LittleDiode supplies new, hard to find or obsolete electronic components and semiconductors all over the world.

With over two million different components listed you are sure to find the part you need.

Feel free to visit us today at our online store:

LittleDiode.com

Looking forward to providing you with the best possible service.