



## 3.3V ZERO DELAY CLOCK BUFFER

**IDT2305**

### FEATURES:

- Phase-Lock Loop Clock Distribution
- 10MHz to 133MHz operating frequency
- Distributes one clock input to one bank of five outputs
- Zero Input-Output Delay
- Output Skew < 250ps
- Low jitter <200 ps cycle-to-cycle
- IDT2305-1 for Standard Drive
- IDT2305-1H for High Drive
- No external RC network required
- Operates at 3.3V V<sub>DD</sub>
- Power down mode
- Available in SOIC package

### DESCRIPTION:

The IDT2305 is a high-speed phase-lock loop (PLL) clock buffer, designed to address high-speed clock distribution applications. The zero delay is achieved by aligning the phase between the incoming clock and the output clock, operable within the range of 10 to 133MHz.

The IDT2305 is an 8-pin version of the IDT2309. IDT2305 accepts one reference input, and drives out five low skew clocks. The -1H version of this device operates, up to 133MHz frequency and has a higher drive than the -1 device. All parts have on-chip PLLs which lock to an input clock on the REF pin. The PLL feedback is on-chip and is obtained from the CLKOUT pad. In the absence of an input clock, the IDT2305 enters power down. In this mode, the device will draw less than 25 $\mu$ A, the outputs are tri-stated, and the PLL is not running, resulting in a significant reduction of power.

The IDT2305 is characterized for both Industrial and Commercial operation.

### FUNCTIONAL BLOCK DIAGRAM

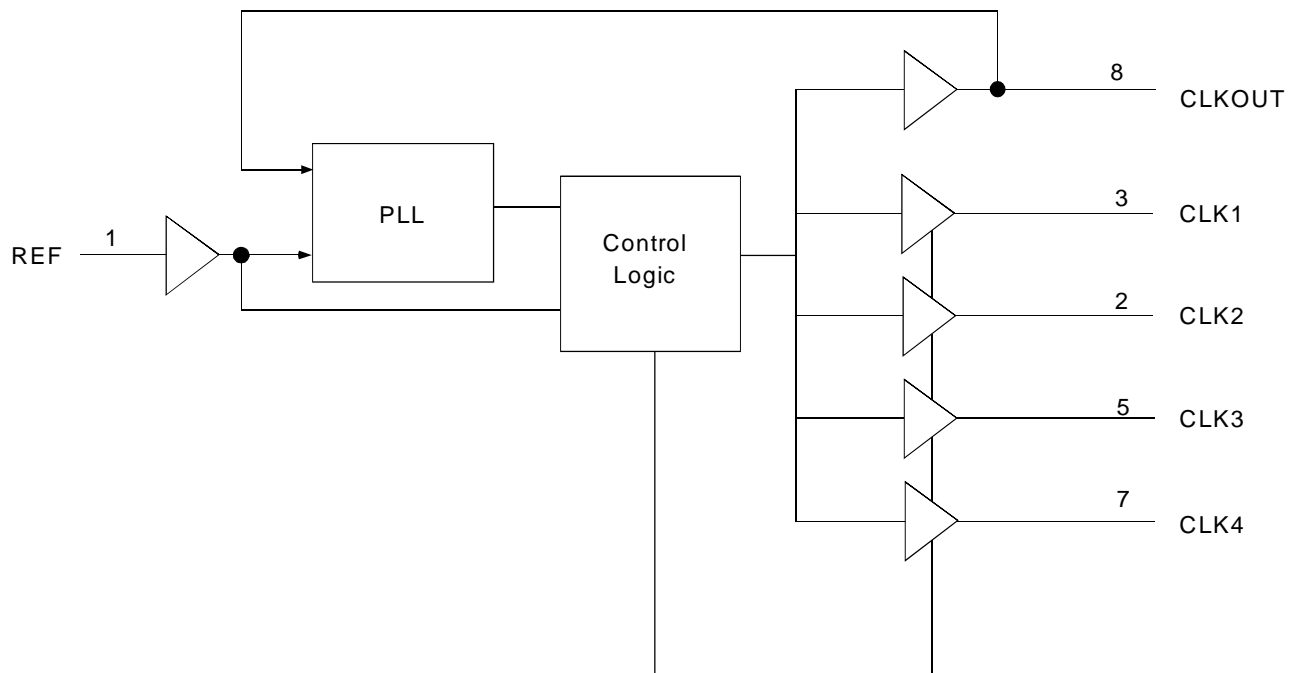

## PIN CONFIGURATION

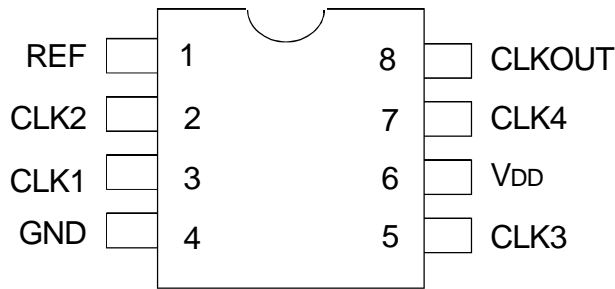

## ABSOLUTE MAXIMUM RATINGS<sup>(1)</sup>

Symbol	Rating	Max.	Unit
V <sub>DD</sub>	Supply Voltage Range	-0.5 to +4.6	V
V <sub>I</sub> <sup>(2)</sup>	Input Voltage Range (REF)	-0.5 to +5.5	V
V <sub>I</sub>	Input Voltage Range (except REF)	-0.5 to V <sub>DD</sub> +0.5	V
I <sub>IK</sub> (V <sub>I</sub> < 0)	Input Clamp Current	-50	mA
I <sub>O</sub> (V <sub>O</sub> = 0 to V <sub>DD</sub> )	Continuous Output Current	±50	mA
V <sub>DD</sub> or GND	Continuous Current	±100	mA
T <sub>A</sub> = 55°C (in still air) <sup>(3)</sup>	Maximum Power Dissipation	0.7	W
T <sub>STG</sub>	Storage Temperature Range	-65 to +150	°C
Operating Temperature	Commercial Temperature Range	0 to +70	°C
Operating Temperature	Industrial Temperature Range	-40 to +85	°C

### NOTES:

- Stresses greater than those listed under ABSOLUTE MAXIMUM RATINGS may cause permanent damage to the device. This is a stress rating only and functional operation of the device at these or any other conditions above those indicated in the operational sections of this specification is not implied. Exposure to absolute maximum rating conditions for extended periods may affect reliability.
- The input and output negative-voltage ratings may be exceeded if the input and output clamp-current ratings are observed.
- The maximum package power dissipation is calculated using a junction temperature of 150°C and a board trace length of 750 mils.

## APPLICATIONS:

- SDRAM
- Telecom
- Datacom
- PC Motherboards/Workstations
- Critical Path Delay Designs

## PIN DESCRIPTION

Pin Name	Pin Number	Type	Functional Description
REF <sup>(1)</sup>	1	IN	Input reference clock, 5 Volt tolerant input
CLK2 <sup>(2)</sup>	2	Out	Output clock
CLK1 <sup>(2)</sup>	3	Out	Output clock
GND	4	Ground	Ground
CLK3 <sup>(2)</sup>	5	Out	Output clock
V <sub>DD</sub>	6	PWR	3.3V Supply
CLK4 <sup>(2)</sup>	7	Out	Output clock
CLKOUT <sup>(2)</sup>	8	Out	Output clock, internal feedback on this pin

### NOTES:

- Weak pull down.
- Weak pull down on all outputs.

## OPERATING CONDITIONS - COMMERCIAL

Symbol	Parameter	Min.	Max.	Unit
V <sub>DD</sub>	Supply Voltage	3	3.6	V
T <sub>A</sub>	Operating Temperature (Ambient Temperature)	0	70	°C
C <sub>L</sub>	Load Capacitance < 100MHz	—	30	pF
	Load Capacitance 100MHz - 133MHz	—	10	
C <sub>IN</sub>	Input Capacitance	—	7	pF

## DC ELECTRICAL CHARACTERISTICS - COMMERCIAL

Symbol	Parameter	Conditions		Min.	Max.	Unit
V <sub>IL</sub>	Input LOW Voltage Level			—	0.8	V
V <sub>IH</sub>	Input HIGH Voltage Level			2	—	V
I <sub>IL</sub>	Input LOW Current	V <sub>IN</sub> = 0V		—	50	μA
I <sub>IH</sub>	Input HIGH Current	V <sub>IN</sub> = V <sub>DD</sub>		—	100	μA
V <sub>OL</sub>	Output LOW Voltage	Standard Drive	I <sub>OL</sub> = 8mA	—	0.4	V
		High Drive	I <sub>OL</sub> = 12mA (-1H)			
V <sub>OH</sub>	Output HIGH Voltage	Standard Drive	I <sub>OH</sub> = -8mA	2.4	—	V
		High Drive	I <sub>OH</sub> = -12mA (-1H)			
I <sub>DD_PD</sub>	Power Down Current	REF = 0MHz		—	12	μA
I <sub>DD</sub>	Supply Current	Unloaded Outputs at 66.66MHz		—	32	mA

## SWITCHING CHARACTERISTICS (2305-1) - COMMERCIAL <sup>(1,2)</sup>

Symbol	Parameter	Conditions	Min.	Typ.	Max.	Unit
t <sub>i</sub>	Output Frequency	10pF Load	10	—	133	MHz
		30pF Load	10	—	100	
	Duty Cycle = t <sub>2</sub> ÷ t <sub>1</sub>	Measured at 1.4V, F <sub>OUT</sub> = 66.66MHz	40	50	60	%
t <sub>r</sub>	Rise Time	Measured between 0.8V and 2V	—	—	2.5	ns
t <sub>f</sub>	Fall Time	Measured between 0.8V and 2V	—	—	2.5	ns
t <sub>s</sub>	Output to Output Skew	All outputs equally loaded	—	—	250	ps
t <sub>d</sub>	Delay, REF Rising Edge to CLKOUT Rising Edge	Measured at V <sub>DD</sub> /2	—	0	±350	ps
t <sub>7</sub>	Device-to-Device Skew	Measured at V <sub>DD</sub> /2 on the CLKOUT pins of devices	—	0	700	ps
t <sub>j</sub>	Cycle-to-Cycle Jitter, pk - pk	Measured at 66.66MHz, loaded outputs	—	—	200	ps
t <sub>LOCK</sub>	PLL Lock Time	Stable power supply, valid clock presented on REF pin	—	—	1	ms

**NOTES:**

- REF Input has a threshold voltage of V<sub>DD</sub>/2.
- All parameters specified with loaded outputs.

## SWITCHING CHARACTERISTICS (2305-1H) - COMMERCIAL <sup>(1,2)</sup>

Symbol	Parameter	Conditions	Min.	Typ.	Max.	Unit
t <sub>f</sub>	Output Frequency	10pF Load	10	—	133	MHz
		30pF Load	10	—	100	
	Duty Cycle = t <sub>2</sub> ÷ t <sub>1</sub>	Measured at 1.4V, F <sub>OUT</sub> = 66.66MHz	40	50	60	%
	Duty Cycle = t <sub>2</sub> ÷ t <sub>1</sub>	Measured at 1.4V, F <sub>OUT</sub> <50MHz	45	50	55	%
t <sub>r</sub>	Rise Time	Measured between 0.8V and 2V	—	—	1.5	ns
t <sub>f</sub>	Fall Time	Measured between 0.8V and 2V	—	—	1.5	ns
t <sub>s</sub>	Output to Output Skew	All outputs equally loaded	—	—	250	ps
t <sub>d</sub>	Delay, REF Rising Edge to CLKOUT Rising Edge	Measured at V <sub>DD</sub> /2	—	0	±350	ps
t <sub>7</sub>	Device-to-Device Skew	Measured at V <sub>DD</sub> /2 on the CLKOUT pins of devices	—	0	700	ps
t <sub>s</sub>	Output Slew Rate	Measured between 0.8V and 2V using Test Circuit #2	1	—	—	V/ns
t <sub>j</sub>	Cycle-to-Cycle Jitter, pk - pk	Measured at 66.66MHz, loaded outputs	—	—	200	ps
t <sub>LOCK</sub>	PLL Lock Time	Stable power supply, valid clock presented on REF pin	—	—	1	ms

### NOTES:

- REF Input has a threshold voltage of V<sub>DD</sub>/2.
- All parameters specified with loaded outputs.

## OPERATING CONDITIONS - INDUSTRIAL

Symbol	Parameter	Min.	Max.	Unit
V <sub>DD</sub>	Supply Voltage	3	3.6	V
T <sub>A</sub>	Operating Temperature (Ambient Temperature)	-40	+85	°C
C <sub>L</sub>	Load Capacitance < 100MHz	—	30	pF
	Load Capacitance 100MHz - 133MHz	—	10	
C <sub>IN</sub>	Input Capacitance	—	7	pF

## DC ELECTRICAL CHARACTERISTICS - INDUSTRIAL

Symbol	Parameter	Conditions		Min.	Max.	Unit
V <sub>IL</sub>	Input LOW Voltage Level			—	0.8	V
V <sub>IH</sub>	Input HIGH Voltage Level			2	—	V
I <sub>IL</sub>	Input LOW Current	V <sub>IN</sub> = 0V		—	50	μA
I <sub>IH</sub>	Input HIGH Current	V <sub>IN</sub> = V <sub>DD</sub>		—	100	μA
V <sub>OL</sub>	Output LOW Voltage	Standard Drive	I <sub>OL</sub> = 8mA	—	0.4	V
		High Drive	I <sub>OL</sub> = 12mA (-1H)			
V <sub>OH</sub>	Output HIGH Voltage	Standard Drive	I <sub>OH</sub> = -8mA	2.4	—	V
		High Drive	I <sub>OH</sub> = -12mA (-1H)			
I <sub>DD_PD</sub>	Power Down Current	REF = 0MHz		—	25	μA
I <sub>DD</sub>	Supply Current	Unloaded Outputs at 66.66MHz		—	35	mA

SWITCHING CHARACTERISTICS (2305-1) - INDUSTRIAL<sup>(1,2)</sup>

Symbol	Parameter	Conditions	Min.	Typ.	Max.	Unit
t <sub>1</sub>	Output Frequency	10pF Load	10	—	133	MHz
		30pF Load	10	—	100	
	Duty Cycle = t <sub>2</sub> ÷ t <sub>1</sub>	Measured at 1.4V, F <sub>OUT</sub> = 66.66MHz	40	50	60	%
t <sub>3</sub>	Rise Time	Measured between 0.8V and 2V	—	—	2.5	ns
t <sub>4</sub>	Fall Time	Measured between 0.8V and 2V	—	—	2.5	ns
t <sub>5</sub>	Output to Output Skew	All outputs equally loaded	—	—	250	ps
t <sub>6</sub>	Delay, REF Rising Edge to CLKOUT Rising Edge	Measured at V <sub>DD</sub> /2	—	0	±350	ps
t <sub>7</sub>	Device-to-Device Skew	Measured at V <sub>DD</sub> /2 on the CLKOUT pins of devices	—	0	700	ps
t <sub>1</sub>	Cycle-to-Cycle Jitter, pk - pk	Measured at 66.66MHz, loaded outputs	—	—	200	ps
t <sub>LOCK</sub>	PLL Lock Time	Stable power supply, valid clock presented on REF pin	—	—	1	ms

## NOTES:

- REF Input has a threshold voltage of V<sub>DD</sub>/2.
- All parameters specified with loaded outputs.

SWITCHING CHARACTERISTICS (2305-1H) - INDUSTRIAL<sup>(1,2)</sup>

Symbol	Parameter	Conditions	Min.	Typ.	Max.	Unit
t <sub>1</sub>	Output Frequency	10pF Load	10	—	133	MHz
		30pF Load	10	—	100	
	Duty Cycle = t <sub>2</sub> ÷ t <sub>1</sub>	Measured at 1.4V, F <sub>OUT</sub> = 66.66MHz	40	50	60	%
	Duty Cycle = t <sub>2</sub> ÷ t <sub>1</sub>	Measured at 1.4V, F <sub>OUT</sub> <50MHz	45	50	55	%
t <sub>3</sub>	Rise Time	Measured between 0.8V and 2V	—	—	1.5	ns
t <sub>4</sub>	Fall Time	Measured between 0.8V and 2V	—	—	1.5	ns
t <sub>5</sub>	Output to Output Skew	All outputs equally loaded	—	—	250	ps
t <sub>6</sub>	Delay, REF Rising Edge to CLKOUT Rising Edge	Measured at V <sub>DD</sub> /2	—	0	±350	ps
t <sub>7</sub>	Device-to-Device Skew	Measured at V <sub>DD</sub> /2 on the CLKOUT pins of devices	—	0	700	ps
t <sub>8</sub>	Output Slew Rate	Measured between 0.8V and 2V using Test Circuit #2	1	—	—	V/ns
t <sub>1</sub>	Cycle-to-Cycle Jitter, pk - pk	Measured at 66.66MHz, loaded outputs	—	—	200	ps
t <sub>LOCK</sub>	PLL Lock Time	Stable power supply, valid clock presented on REF pin	—	—	1	ms

## NOTES:

- REF Input has a threshold voltage of V<sub>DD</sub>/2.
- All parameters specified with loaded outputs.

## ZERO DELAY AND SKEW CONTROL

All outputs should be uniformly loaded in order to achieve Zero I/O Delay. Since the CLKOUT pin is the internal feedback for the PLL, its relative loading can affect and adjust the input/output delay. The Output Load Difference diagram illustrates the PLL's relative loading with respect to the other outputs that can adjust the Input-Output (I/O) Delay.

For designs utilizing zero I/O Delay, all outputs including CLKOUT must be equally loaded. Even if the output is not used, it must have a capacitive load equal to that on the other outputs in order to obtain true zero I/O Delay. If I/O Delay adjustments are needed, use the Output Load Difference diagram to calculate loading differences between the CLKOUT pin and other outputs. For zero output-to-output skew, all outputs must be loaded equally.

REF TO CLKA/CLKB RELAY vs. OUTPUT LOAD DIFFERENCE BETWEEN CLKOUT PIN AND CLKA/CLKB PINS

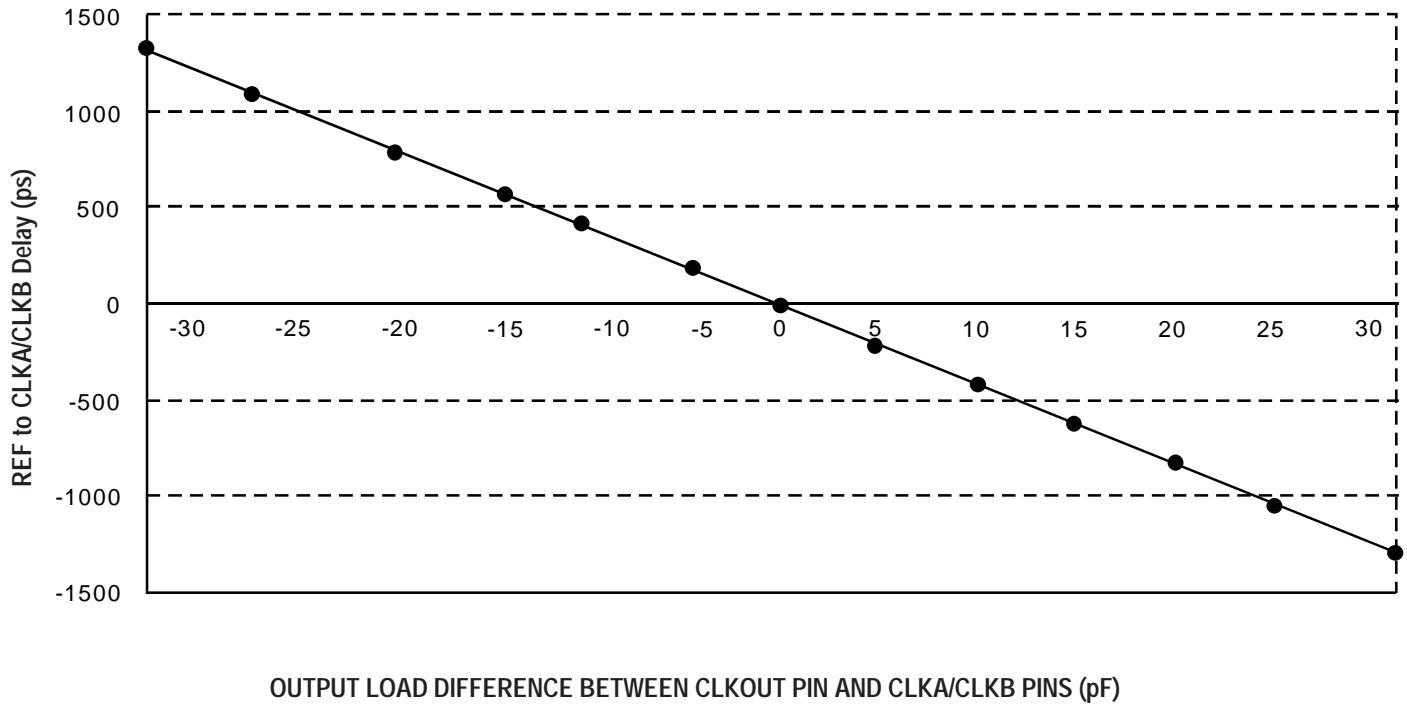

## SWITCHING WAVEFORMS

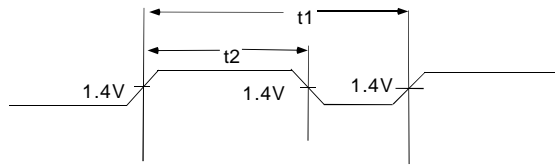

*Duty Cycle Timing*

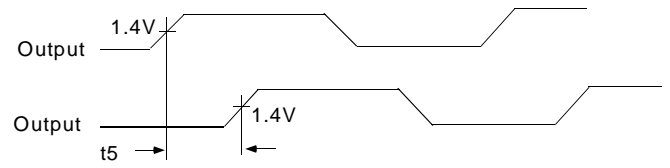

*Output to Output Skew*

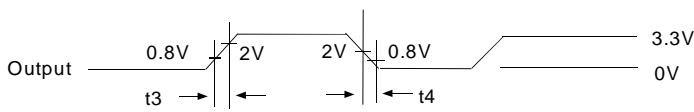

*All Outputs Rise/Fall Time*

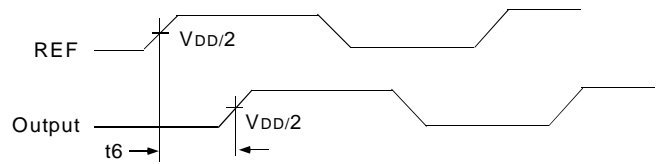

*Input to Output Propagation Delay*

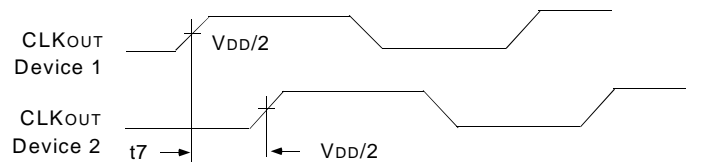

*Device to Device Skew*

## TEST CIRCUITS

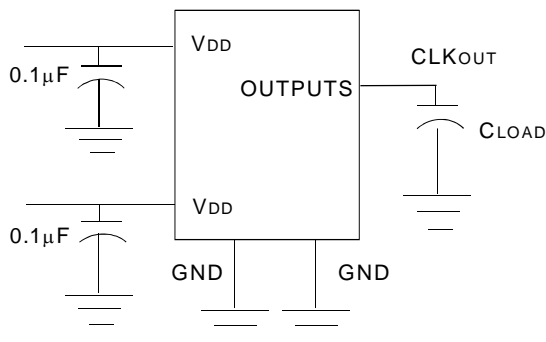

*Test Circuit 1 (all Parameters Except  $t_8$ )*

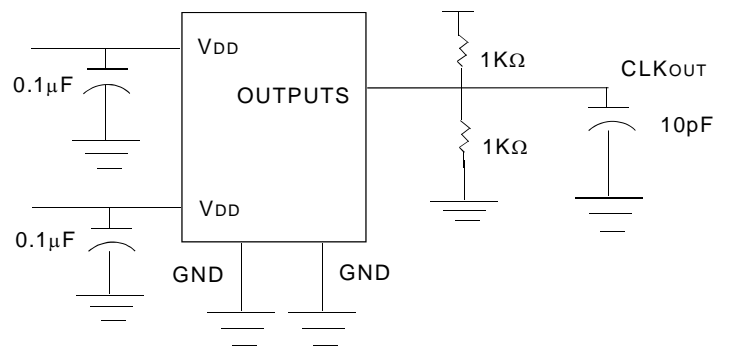

*Test Circuit 2 ( $t_8$ , Output Slew Rate On -1H Devices)*

## TYPICAL DUTY CYCLE<sup>(1)</sup> AND I<sub>DD</sub> TRENDS<sup>(2)</sup> FOR IDT2305-1

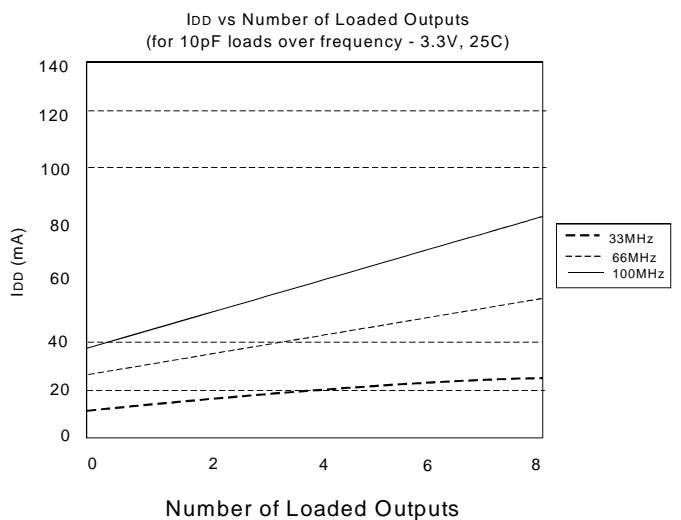
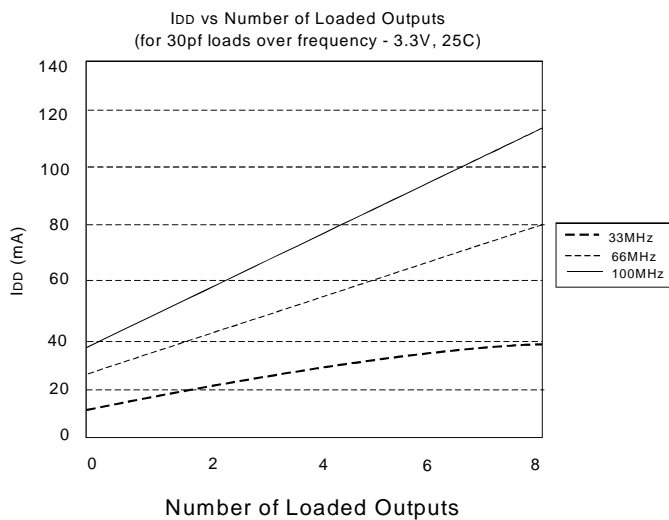
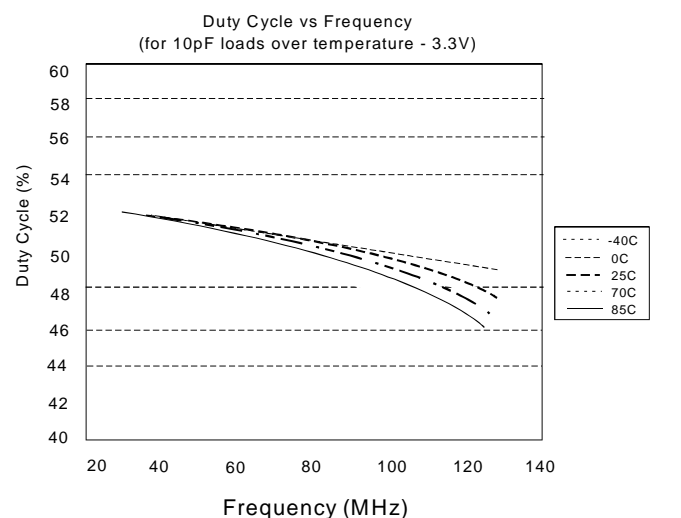
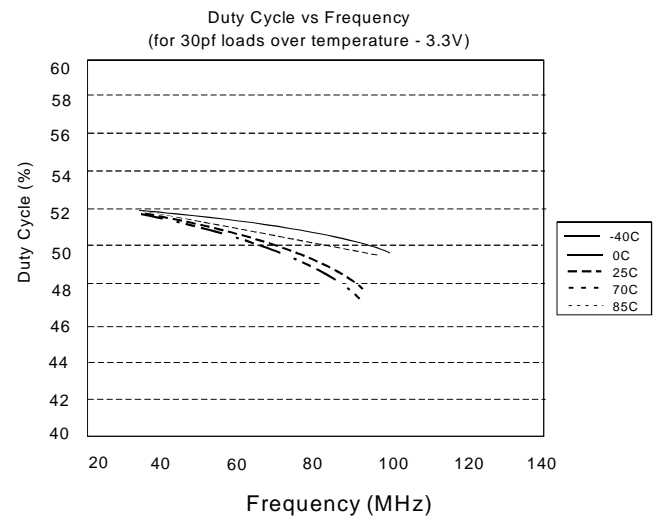
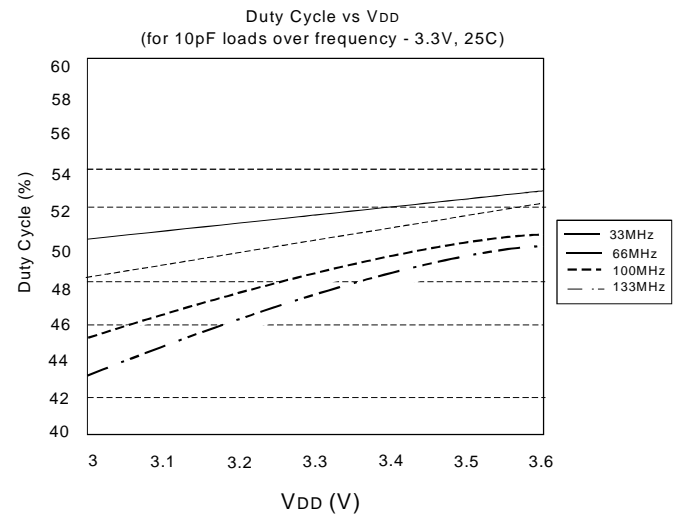
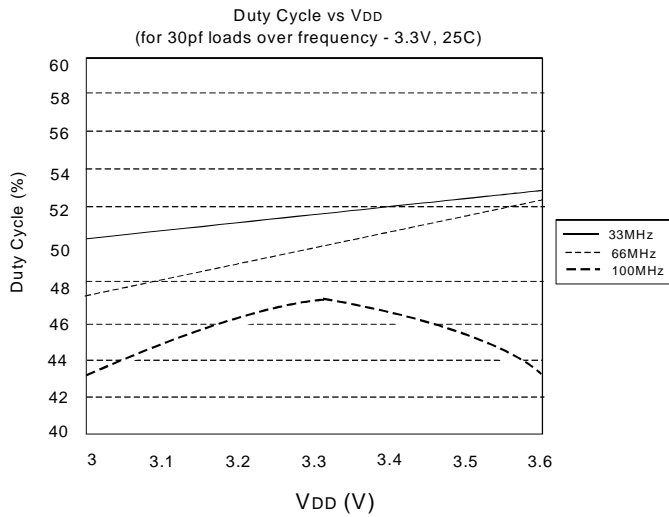

**NOTES:**

- Duty Cycle is taken from typical chip measured at 1.4V.
- I<sub>DD</sub> data is calculated from  $I_{DD} = I_{CORE} + nCVf$ , where I<sub>CORE</sub> is the unloaded current. (n = Number of outputs; C = Capacitance load per output (F); V = Supply Voltage (V); f = Frequency (Hz))

## TYPICAL DUTY CYCLE<sup>(1)</sup> AND I<sub>DD</sub> TRENDS<sup>(2)</sup> FOR IDT2305-1H

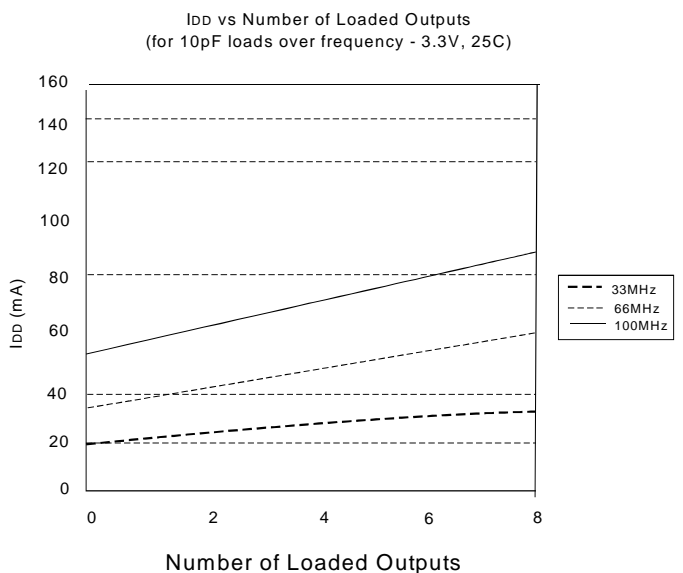
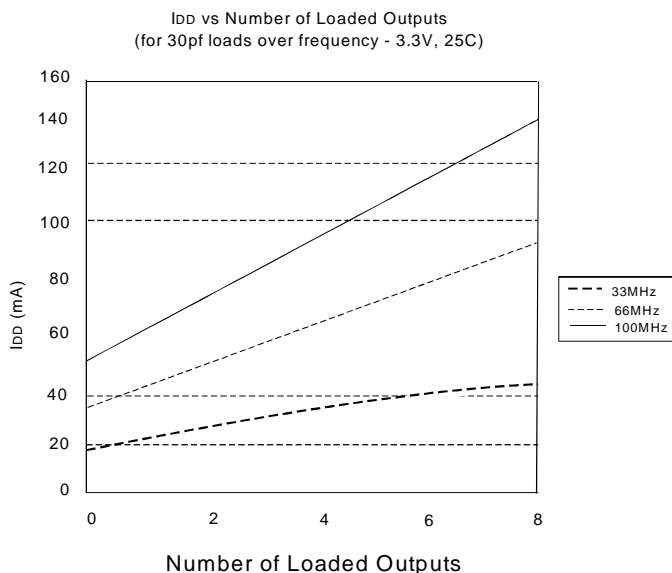
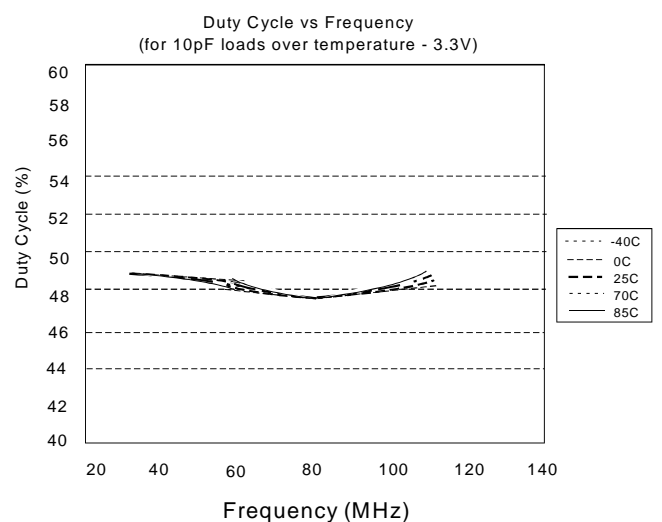
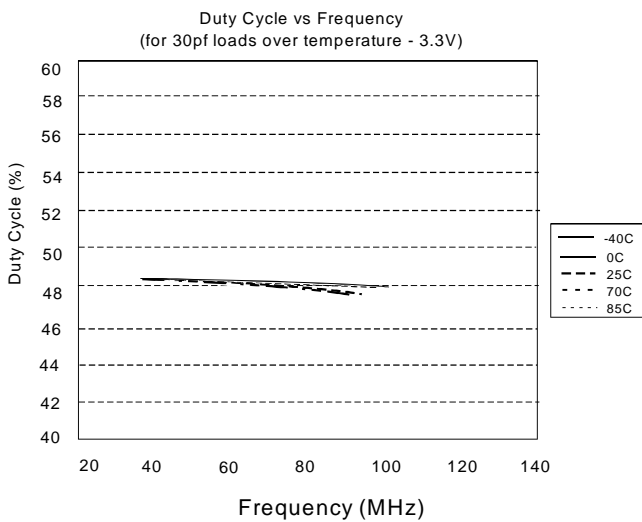
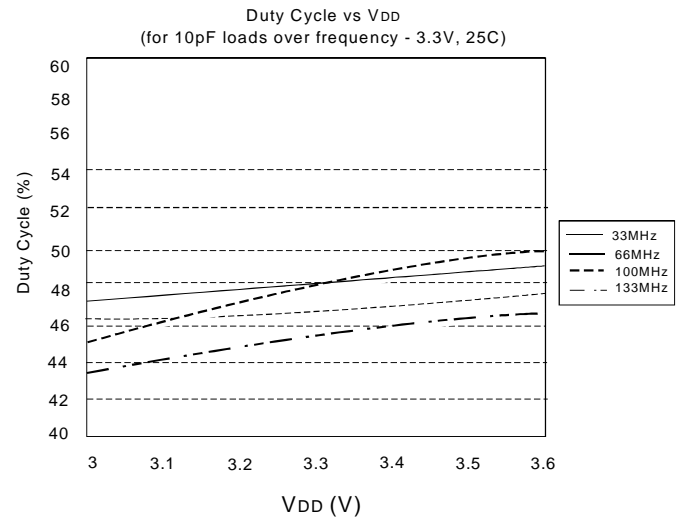
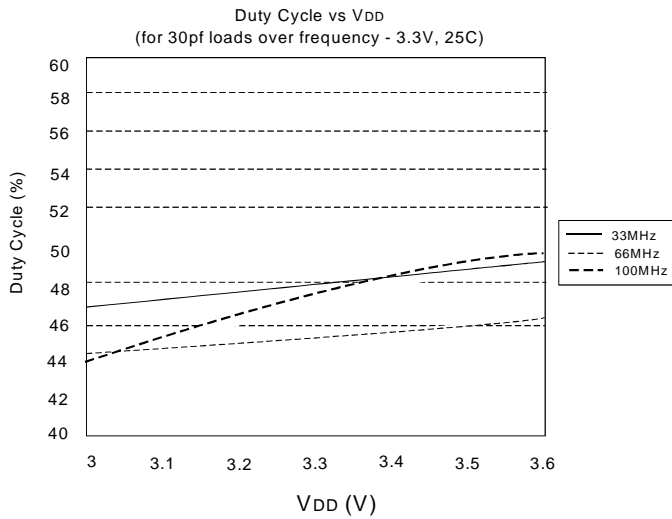

NOTES:

- Duty Cycle is taken from typical chip measured at 1.4V.
- I<sub>DD</sub> data is calculated from  $I_{DD} = I_{CORE} + nCfV$ , where I<sub>CORE</sub> is the unloaded current. (n = Number of outputs; C = Capacitance load per output (F); V = Supply Voltage (V); f = Frequency (Hz))

**ORDERING INFORMATION**

IDT XXXXX XX X  
 Device Type Package Process

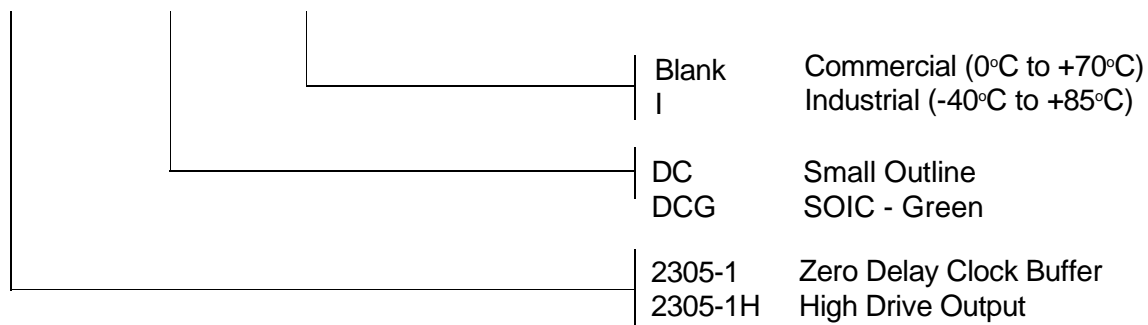

Ordering Code	Package Type	Operating Range
IDT2305-1DC	8-Pin SOIC	Commercial
IDT2305-1DCG	8-Pin SOIC	Commercial
IDT2305-1DCI	8-Pin SOIC	Industrial
IDT2305-1DCGI	8-Pin SOIC	Industrial
IDT2305-1HDC	8-Pin SOIC	Commercial
IDT2305-1HDCI	8-Pin SOIC	Industrial



**CORPORATE HEADQUARTERS**  
 2975 Stender Way  
 Santa Clara, CA 95054

**for SALES:**  
 800-345-7015 or 408-727-6116  
 fax: 408-492-8674  
 www.idt.com

**for Tech Support:**  
 logichelp@idt.com  
 (408) 654-6459



LittleDiode supplies new, hard to find or obsolete electronic components and semiconductors all over the world.

With over two million different components listed you are sure to find the part you need.

Feel free to visit us today at our online store:

[LittleDiode.com](http://LittleDiode.com)

Looking forward to providing you with the best possible service.