

## IR2109(4) (S)

### HALF-BRIDGE DRIVER

#### Features

- Floating channel designed for bootstrap operation Fully operational to +600V Tolerant to negative transient voltage dV/dt immune
- Gate drive supply range from 10 to 20V
- Undervoltage lockout for both channels
- 3.3V, 5V and 15V input logic compatible
- Cross-conduction prevention logic
- Matched propagation delay for both channels
- High side output in phase with IN input
- Logic and power ground +/- 5V offset.
- Internal 540ns dead-time, and programmable up to 5us with one external R<sub>DT</sub> resistor (IR21094)
- Lower di/dt gate driver for better noise immunity
- Shut down input turns off both channels.

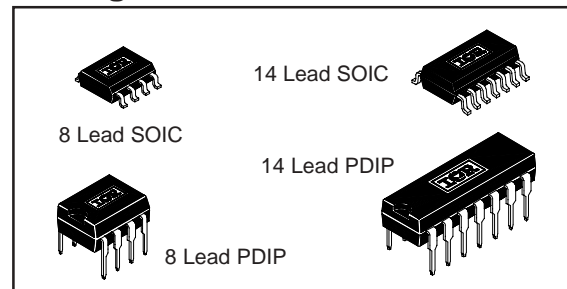
#### Description

The IR2109(4)(S) are high voltage, high speed power MOSFET and IGBT drivers with dependent high and low side referenced output channels. Proprietary HVIC and latch immune CMOS technologies enable ruggedized monolithic construction. The logic input is compatible with standard CMOS or LSTTL output, down to 3.3V logic. The output drivers feature a high pulse current buffer stage designed for minimum driver cross-conduction. The floating channel can be used to drive an N-channel power MOSFET or IGBT in the high side configuration which operates up to 600 volts.

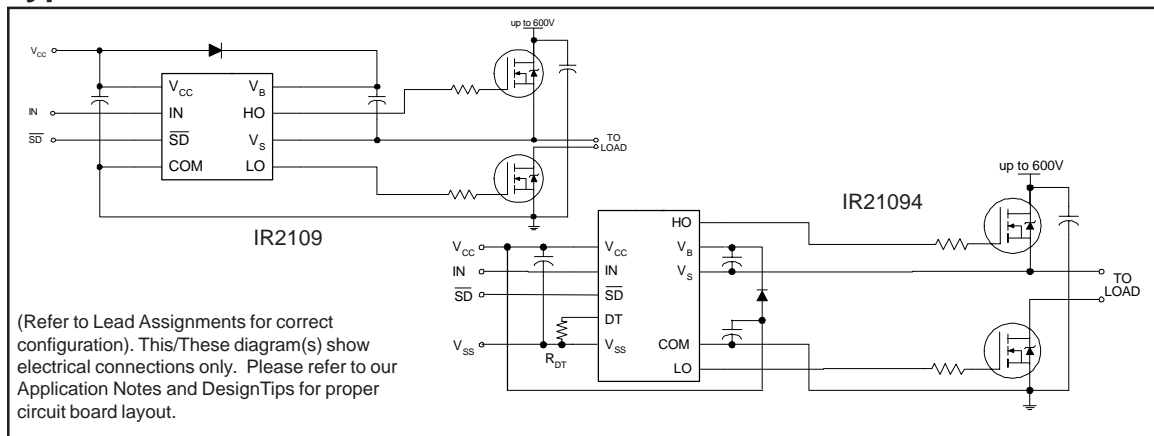
#### Product Summary

|                                      |                 |
|--------------------------------------|-----------------|
| V <sub>OFFSET</sub>                  | 600V max.       |
| I <sub>O+/-</sub>                    | 120 mA / 250 mA |
| V <sub>OUT</sub>                     | 10 - 20V        |
| t <sub>on/off</sub> (typ.)           | 750 & 200 ns    |
| Dead Time                            | 540 ns          |
| (programmable up to 5us for IR21094) |                 |

#### Packages



#### Typical Connection



# IR2109(4) (S)

## Absolute Maximum Ratings

Absolute maximum ratings indicate sustained limits beyond which damage to the device may occur. All voltage parameters are absolute voltages referenced to COM. The thermal resistance and power dissipation ratings are measured under board mounted and still air conditions.

| Symbol              | Definition                                         | Min.                  | Max.                  | Units |      |
|---------------------|----------------------------------------------------|-----------------------|-----------------------|-------|------|
| V <sub>B</sub>      | High side floating absolute voltage                | -0.3                  | 625                   | V     |      |
| V <sub>S</sub>      | High side floating supply offset voltage           | V <sub>B</sub> - 25   | V <sub>B</sub> + 0.3  |       |      |
| V <sub>HO</sub>     | High side floating output voltage                  | V <sub>S</sub> - 0.3  | V <sub>B</sub> + 0.3  |       |      |
| V <sub>CC</sub>     | Low side and logic fixed supply voltage            | -0.3                  | 25                    |       |      |
| V <sub>LO</sub>     | Low side output voltage                            | -0.3                  | V <sub>CC</sub> + 0.3 |       |      |
| DT                  | Programmable dead-time pin voltage (IR21094 only)  | V <sub>SS</sub> - 0.3 | V <sub>CC</sub> + 0.3 |       |      |
| V <sub>IN</sub>     | Logic input voltage (IN & $\overline{SD}$ )        | V <sub>SS</sub> - 0.3 | V <sub>CC</sub> + 0.3 |       |      |
| V <sub>SS</sub>     | Logic ground (IR21094/IR21894 only)                | V <sub>CC</sub> - 25  | V <sub>CC</sub> + 0.3 |       |      |
| dV <sub>S</sub> /dt | Allowable offset supply voltage transient          | —                     | 50                    | V/ns  |      |
| P <sub>D</sub>      | Package power dissipation @ T <sub>A</sub> ≤ +25°C | (8 Lead PDIP)         | —                     | 1.0   | W    |
|                     |                                                    | (8 Lead SOIC)         | —                     | 0.625 |      |
|                     |                                                    | (14 lead PDIP)        | —                     | 1.6   |      |
|                     |                                                    | (14 lead SOIC)        | —                     | 1.0   |      |
| R <sub>thJA</sub>   | Thermal resistance, junction to ambient            | (8 Lead PDIP)         | —                     | 125   | °C/W |
|                     |                                                    | (8 Lead SOIC)         | —                     | 200   |      |
|                     |                                                    | (14 lead PDIP)        | —                     | 75    |      |
|                     |                                                    | (14 lead SOIC)        | —                     | 120   |      |
| T <sub>J</sub>      | Junction temperature                               | —                     | 150                   | °C    |      |
| T <sub>S</sub>      | Storage temperature                                | -50                   | 150                   |       |      |
| T <sub>L</sub>      | Lead temperature (soldering, 10 seconds)           | —                     | 300                   |       |      |

## Recommended Operating Conditions

The input/output logic timing diagram is shown in figure 1. For proper operation the device should be used within the recommended conditions. The  $V_S$  and  $V_{SS}$  offset rating are tested with all supplies biased at 15V differential.

| Symbol   | Definition                                        | Min.       | Max.       | Units |
|----------|---------------------------------------------------|------------|------------|-------|
| $V_B$    | High side floating supply absolute voltage        | $V_S + 10$ | $V_S + 20$ | V     |
| $V_S$    | High side floating supply offset voltage          | Note 1     | 600        |       |
| $V_{HO}$ | High side floating output voltage                 | $V_S$      | $V_B$      |       |
| $V_{CC}$ | Low side and logic fixed supply voltage           | 10         | 20         |       |
| $V_{LO}$ | Low side output voltage                           | 0          | $V_{CC}$   |       |
| $V_{IN}$ | Logic input voltage (IN & $\overline{SD}$ )       | $V_{SS}$   | $V_{CC}$   |       |
| DT       | Programmable dead-time pin voltage (IR21094 only) | $V_{SS}$   | $V_{CC}$   |       |
| $V_{SS}$ | Logic ground (IR21094 only)                       | -5         | 5          |       |
| $T_A$    | Ambient temperature                               | -40        | 125        | °C    |

Note 1: Logic operational for  $V_S$  of -5V to +600V. Logic state held for  $V_S$  of -5V to  $-V_{BS}$ . (Please refer to the Design Tip DT97-3 for more details).

## Dynamic Electrical Characteristics

$V_{BIAS}$  ( $V_{CC}$ ,  $V_{BS}$ ) = 15V,  $V_{SS}$  = COM,  $C_L$  = 1000 pF,  $T_A$  = 25°C, DT =  $V_{SS}$  unless otherwise specified.

| Symbol    | Definition                                                                          | Min. | Typ. | Max. | Units | Test Conditions      |
|-----------|-------------------------------------------------------------------------------------|------|------|------|-------|----------------------|
| $t_{on}$  | Turn-on propagation delay                                                           | —    | 750  | 950  | nsec  | $V_S = 0V$           |
| $t_{off}$ | Turn-off propagation delay                                                          | —    | 200  | 280  |       | $V_S = 0V$ or 600V   |
| $t_{sd}$  | Shut-down propagation delay                                                         | —    | 200  | 280  |       |                      |
| MT        | Delay matching, HS & LS turn-on/off                                                 | —    | 0    | 70   |       |                      |
| $t_r$     | Turn-on rise time                                                                   | —    | 150  | 220  |       | $V_S = 0V$           |
| $t_f$     | Turn-off fall time                                                                  | —    | 50   | 80   |       | $V_S = 0V$           |
| DT        | Deadtime: LO turn-off to HO turn-on (DTLO-HO) & HO turn-off to LO turn-on (DTHO-LO) | 400  | 540  | 680  | usec  | RDT = 0              |
|           |                                                                                     | 4    | 5    | 6    |       | RDT = 200k (IR21094) |
| MDT       | Deadtime matching = DTLO - HO - DTHO-LO                                             | —    | 0    | 60   | nsec  | RDT=0                |
|           |                                                                                     | —    | 0    | 600  |       | RDT = 200k (IR21094) |

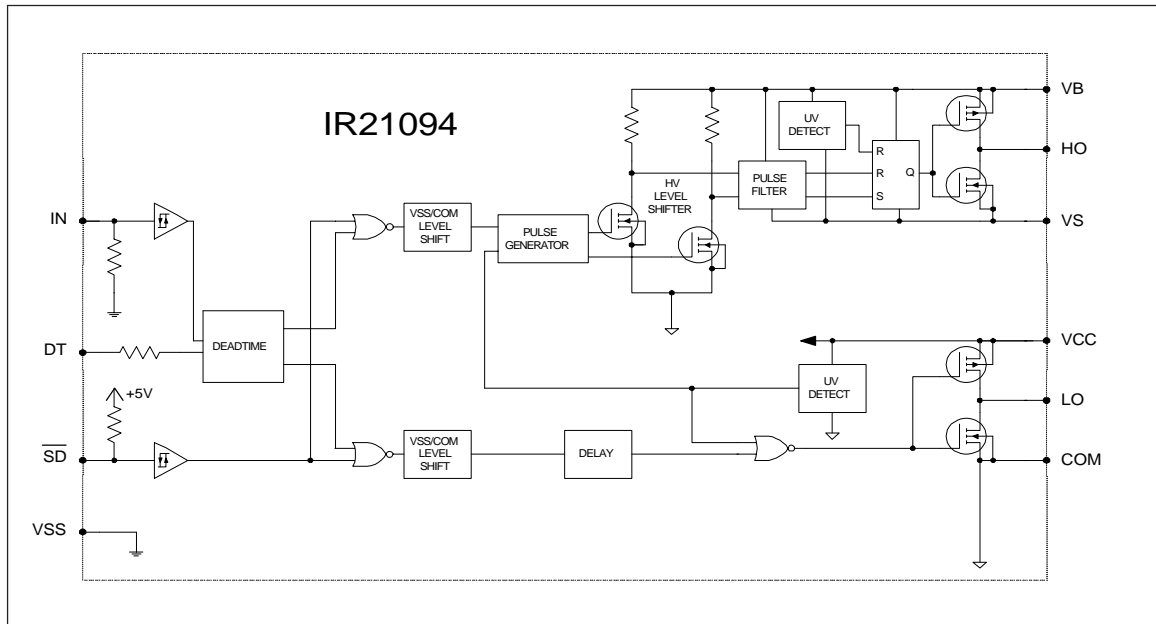
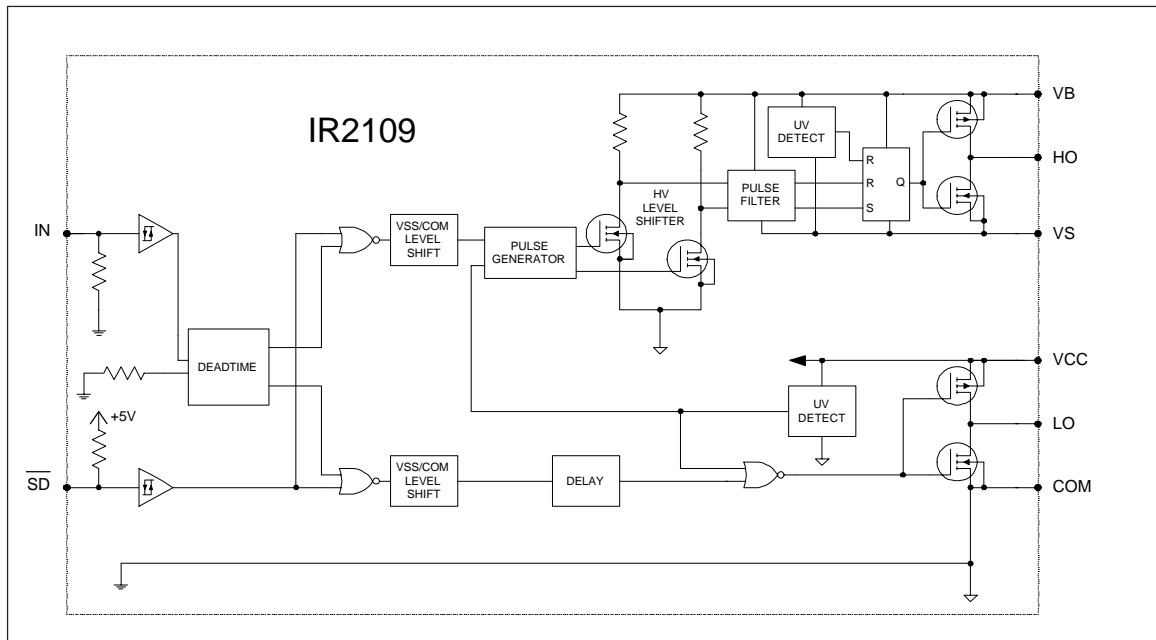
# IR2109(4) (S)

## Static Electrical Characteristics

$V_{BIAS}$  ( $V_{CC}$ ,  $V_{BS}$ ) = 15V,  $V_{SS}$  = COM,  $DT = V_{SS}$  and  $T_A = 25^\circ\text{C}$  unless otherwise specified. The  $V_{IL}$ ,  $V_{IH}$  and  $I_{IN}$  parameters are referenced to  $V_{SS}$  /COM and are applicable to the respective input leads: IN and SD. The  $V_O$ ,  $I_O$  and  $R_{on}$  parameters are referenced to COM and are applicable to the respective output leads: HO and LO.

| Symbol                     | Definition                                                         | Min. | Typ. | Max. | Units         | Test Conditions                                |
|----------------------------|--------------------------------------------------------------------|------|------|------|---------------|------------------------------------------------|
| $V_{IH}$                   | Logic "1" input voltage for HO & logic "0" for LO                  | 2.9  | —    | —    | V             | $V_{CC} = 10\text{V to }20\text{V}$            |
| $V_{IL}$                   | Logic "0" input voltage for HO & logic "1" for LO                  | —    | —    | 0.8  |               | $V_{CC} = 10\text{V to }20\text{V}$            |
| $V_{SD,TH+}$               | $\overline{SD}$ input positive going threshold                     | 2.9  | —    | —    |               | $V_{CC} = 10\text{V to }20\text{V}$            |
| $V_{SD,TH-}$               | $\overline{SD}$ input negative going threshold                     | —    | —    | 0.8  |               | $V_{CC} = 10\text{V to }20\text{V}$            |
| $V_{OH}$                   | High level output voltage, $V_{BIAS} - V_O$                        | —    | 0.8  | 1.4  |               | $I_O = 20\text{ mA}$                           |
| $V_{OL}$                   | Low level output voltage, $V_O$                                    | —    | 0.3  | 0.6  |               | $I_O = 20\text{ mA}$                           |
| $I_{LK}$                   | Offset supply leakage current                                      | —    | —    | 50   | $\mu\text{A}$ | $V_B = V_S = 600\text{V}$                      |
| $I_{QBS}$                  | Quiescent $V_{BS}$ supply current                                  | 20   | 75   | 130  |               | $V_{IN} = 0\text{V or }5\text{V}$              |
| $I_{QCC}$                  | Quiescent $V_{CC}$ supply current                                  | 0.4  | 1.0  | 1.6  | mA            | $V_{IN} = 0\text{V or }5\text{V}$<br>$RDT = 0$ |
| $I_{IN+}$                  | Logic "1" input bias current                                       | —    | 5    | 20   | $\mu\text{A}$ | $IN = 5\text{V}, \overline{SD} = 0\text{V}$    |
| $I_{IN-}$                  | Logic "0" input bias current                                       | —    | —    | 2    |               | $IN = 0\text{V}, \overline{SD} = 5\text{V}$    |
| $V_{CCUV+}$<br>$V_{BSUV+}$ | $V_{CC}$ and $V_{BS}$ supply undervoltage positive going threshold | 8.0  | 8.9  | 9.8  | V             |                                                |
| $V_{CCUV-}$<br>$V_{BSUV-}$ | $V_{CC}$ and $V_{BS}$ supply undervoltage negative going threshold | 7.4  | 8.2  | 9.0  |               |                                                |
| $V_{CCUVH}$<br>$V_{BSUVH}$ | Hysteresis                                                         | 0.3  | 0.7  | —    |               |                                                |
| $I_{O+}$                   | Output high short circuit pulsed current                           | 120  | 200  | —    | mA            | $V_O = 0\text{V}, PW \leq 10\ \mu\text{s}$     |
| $I_{O-}$                   | Output low short circuit pulsed current                            | 250  | 350  | —    |               | $V_O = 15\text{V}, PW \leq 10\ \mu\text{s}$    |

**Functional Block Diagrams**



# IR2109(4) (S)

## Lead Definitions

| Symbol          | Description                                                                                                                            |
|-----------------|----------------------------------------------------------------------------------------------------------------------------------------|
| IN              | Logic input for high and low side gate driver outputs (HO and LO), in phase with HO (referenced to COM for IR2109 and VSS for IR21094) |
| $\overline{SD}$ | Logic input for shutdown (referenced to COM for IR2109 and VSS for IR21094)                                                            |
| DT              | Programmable dead-time lead, referenced to VSS. (IR21094 only)                                                                         |
| VSS             | Logic Ground (21094 only)                                                                                                              |
| $V_B$           | High side floating supply                                                                                                              |
| HO              | High side gate drive output                                                                                                            |
| $V_S$           | High side floating supply return                                                                                                       |
| $V_{CC}$        | Low side and logic fixed supply                                                                                                        |
| LO              | Low side gate drive output                                                                                                             |
| COM             | Low side return                                                                                                                        |

## Lead Assignments

|                    |                    |
|--------------------|--------------------|
| <p>8 Lead PDIP</p> | <p>8 Lead SOIC</p> |
| <b>IR2109</b>      | <b>IR2109S</b>     |

|                     |                     |
|---------------------|---------------------|
| <p>14 Lead PDIP</p> | <p>14 Lead SOIC</p> |
| <b>IR21094</b>      | <b>IR21094S</b>     |

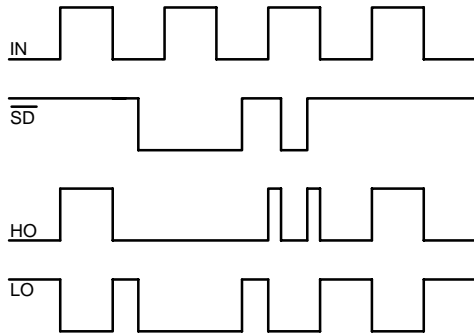


Figure 1. Input/Output Timing Diagram

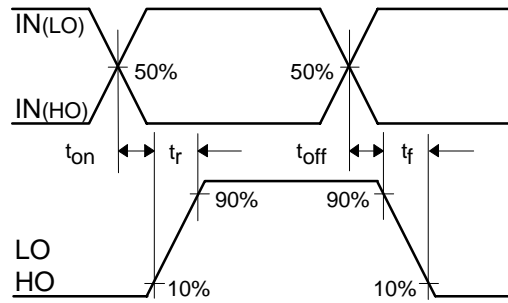


Figure 2. Switching Time Waveform Definitions

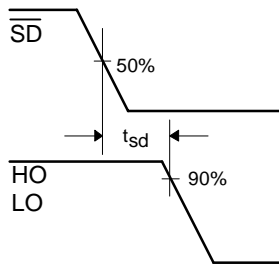


Figure 3. Shutdown Waveform Definitions

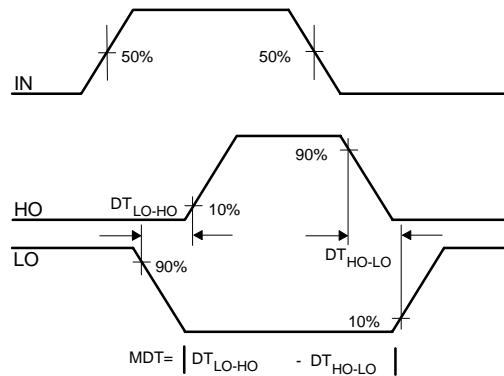


Figure 4. Deadtime Waveform Definitions

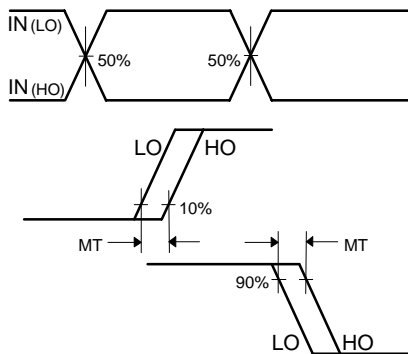
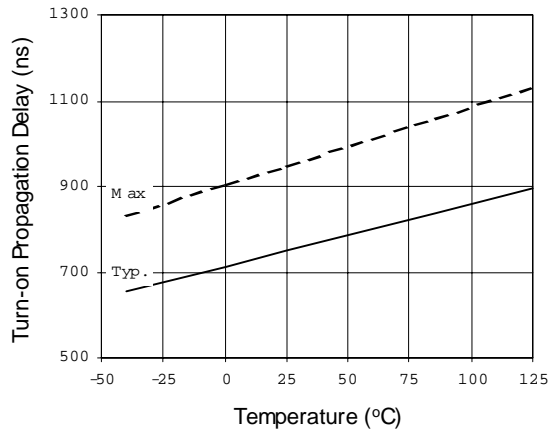
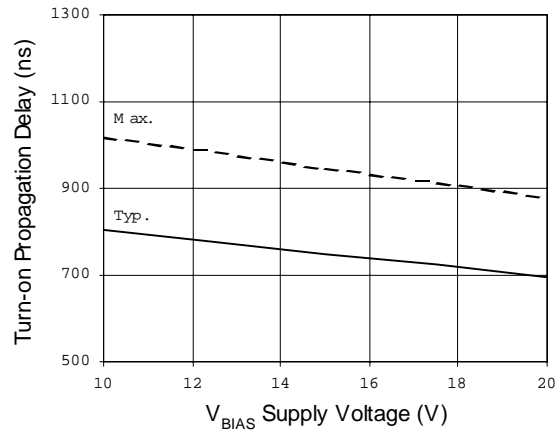


Figure 5. Delay Matching Waveform Definitions

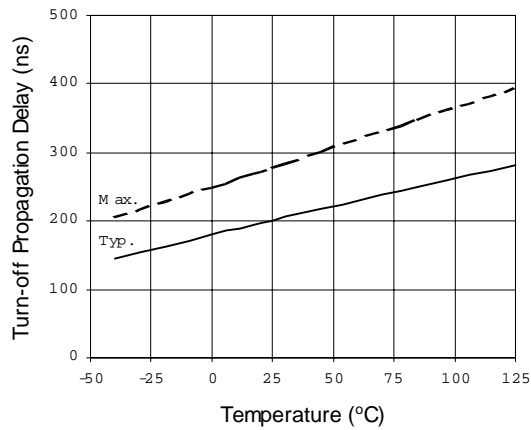
# IR2109(4) (S)



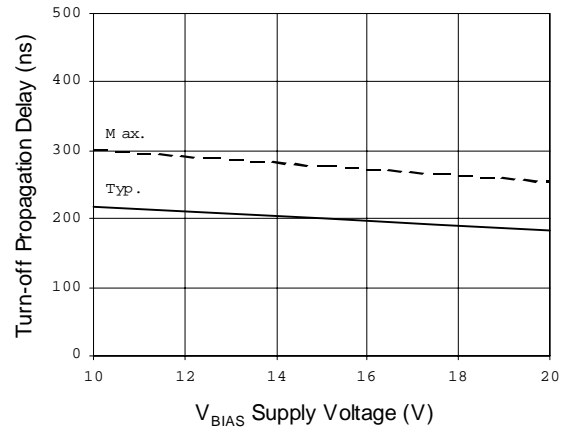
**Figure 6A. Turn-on Propagation Delay vs. Temperature**



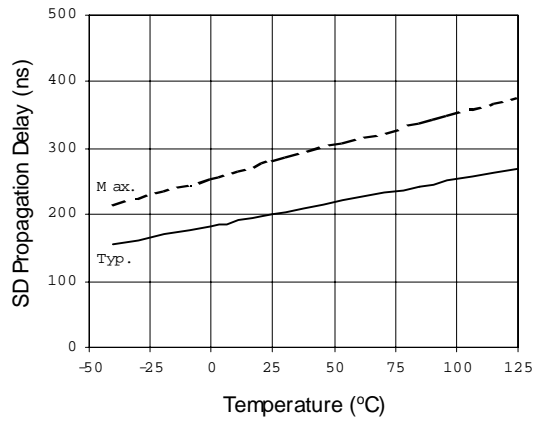
**Figure 6B. Turn-on Propagation Delay vs. Supply Voltage**



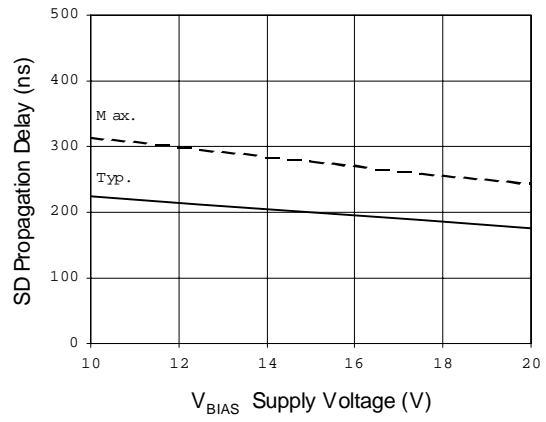
**Figure 7A. Turn-off Propagation Delay vs. Temperature**



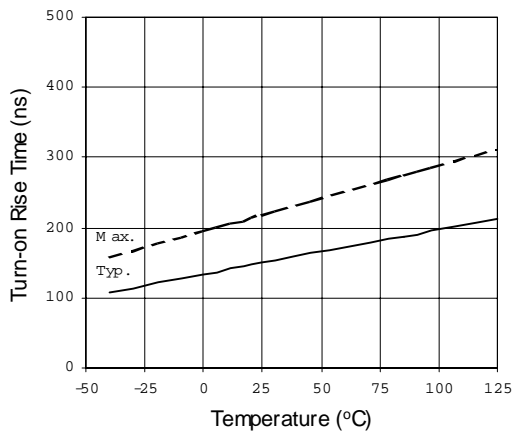
**Figure 7B. Turn-off Propagation Delay vs. Supply Voltage**



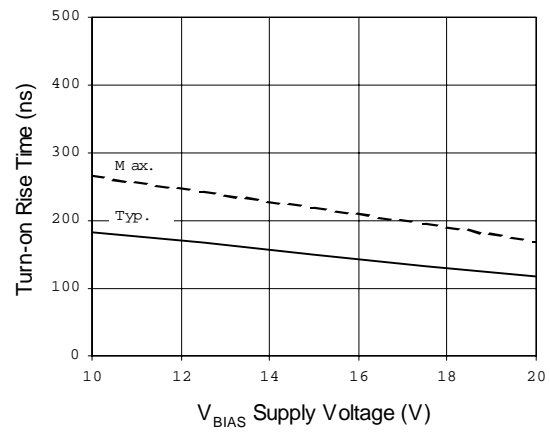
**Figure 8A. SD Propagation Delay vs. Temperature**



**Figure 8B. SD Propagation Delay vs. Supply Voltage**

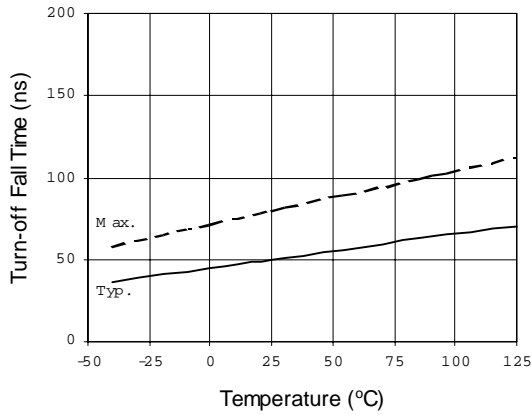


**Figure 9A. Turn-on Rise Time vs. Temperature**

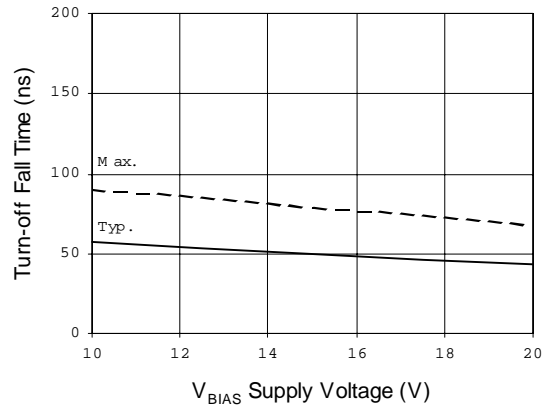


**Figure 9B. Turn-on Rise Time vs. Supply Voltage**

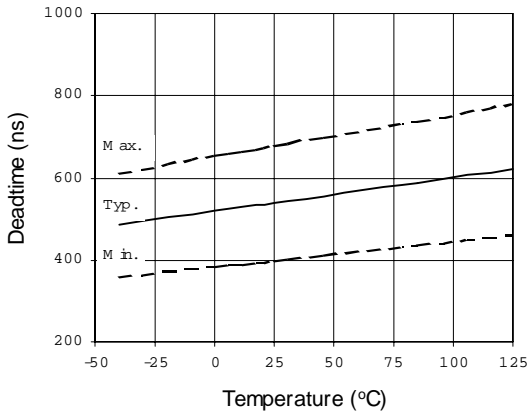
# IR2109(4) (S)



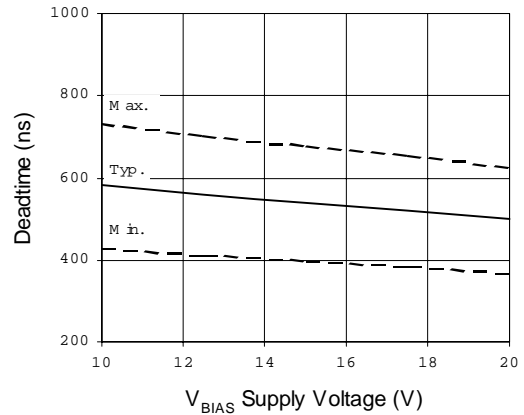
**Figure 10A. Turn-off Fall Time vs. Temperature**



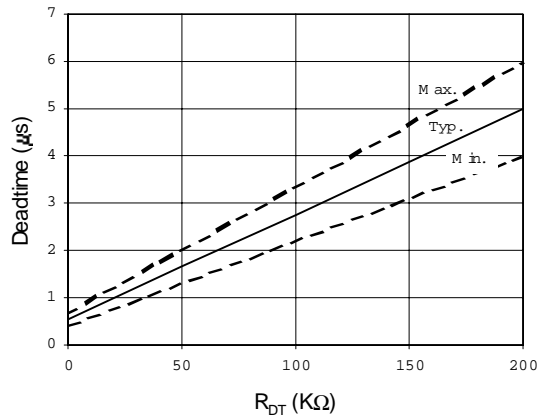
**Figure 10B. Turn-off Fall Time vs. Supply Voltage**



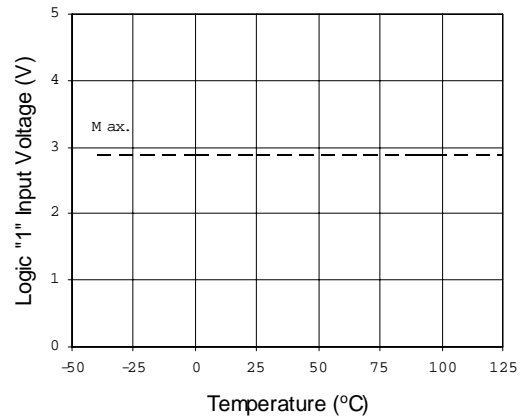
**Figure 11A. Deadtime vs. Temperature**



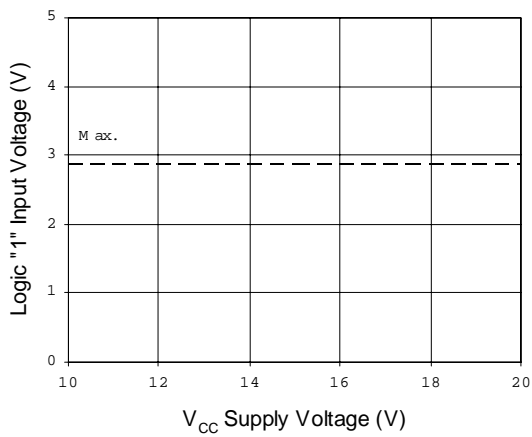
**Figure 11B. Deadtime vs. Supply Voltage**



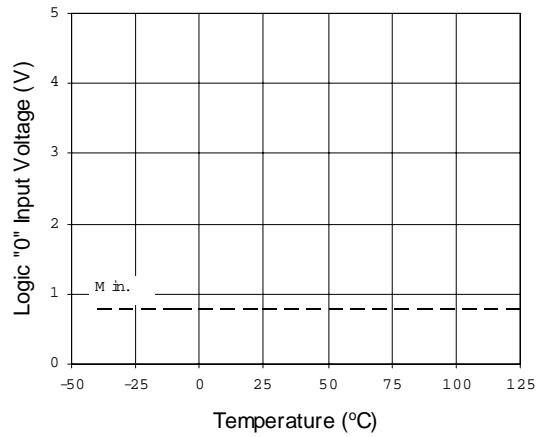
**Figure 11C. Deadtime vs. R<sub>DT</sub>  
 (IR21094 only)**



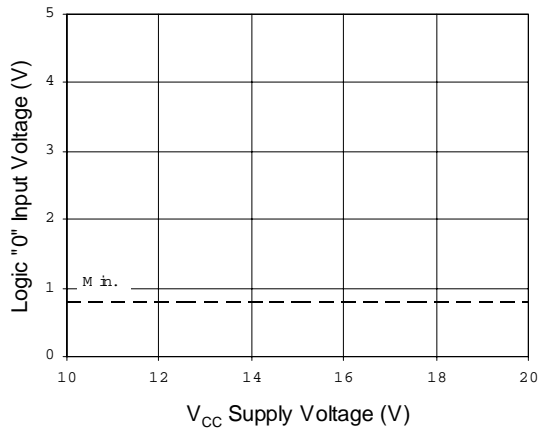
**Figure 12A. Logic "1" Input Voltage  
 vs. Temperature**



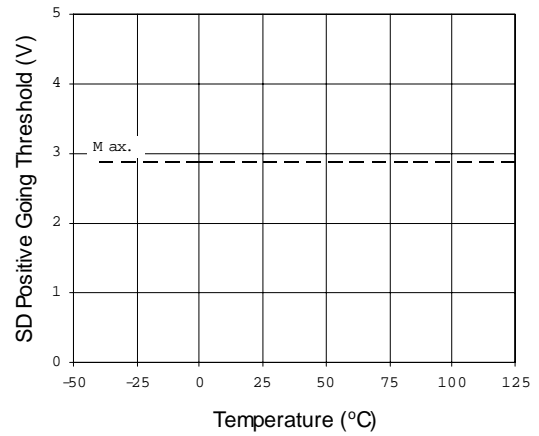
**Figure 12B. Logic "1" Input Voltage  
 vs. Supply Voltage**



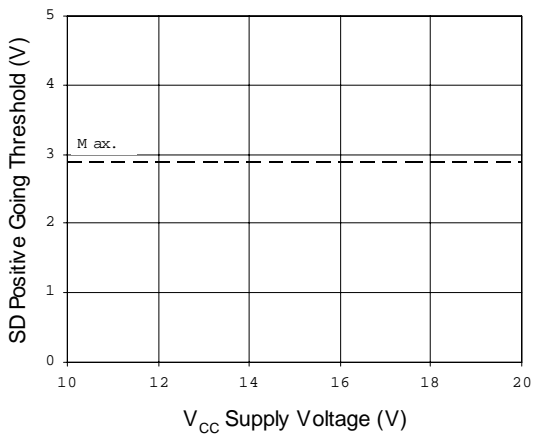
**Figure 13A. Logic "0" Input Voltage  
 vs. Temperature**



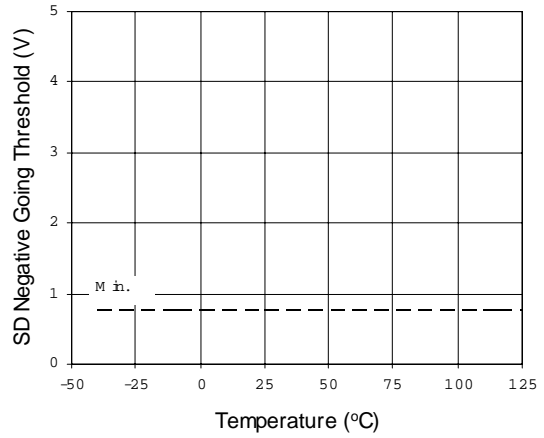
**Figure 13B. Logic "0" Input Current vs. Supply Voltage**



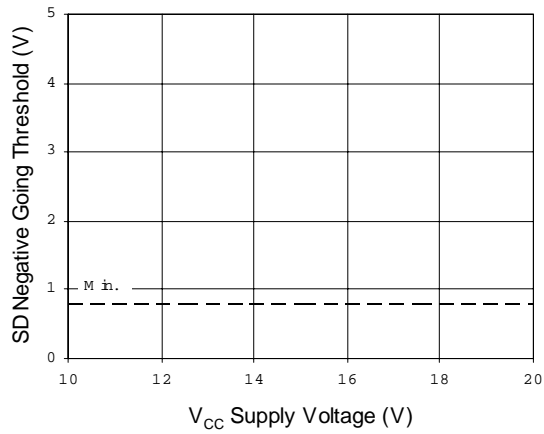
**Figure 14A. SD Positive Going Threshold vs. Temperature**



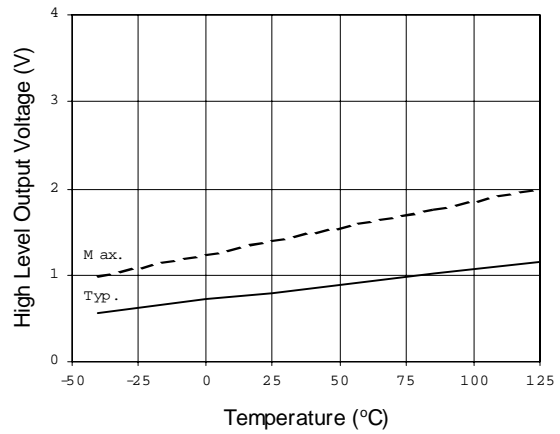
**Figure 14B. SD Positive Going Threshold vs. Supply Voltage**



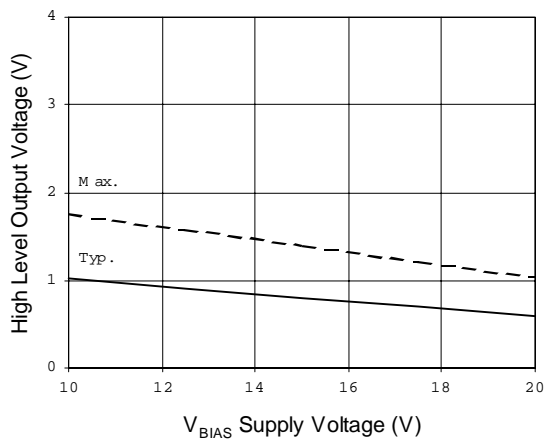
**Figure 15A. SD Negative Going Threshold vs. Temperature**



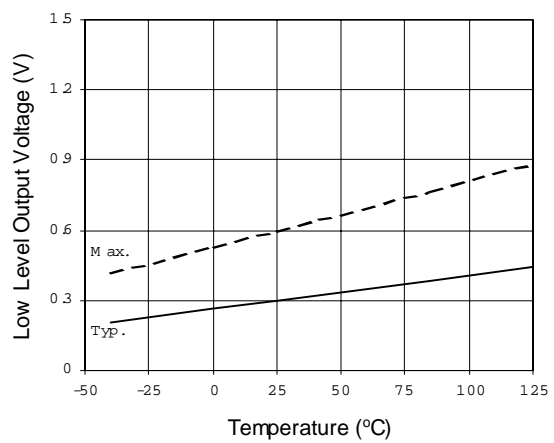
**Figure 15B. SD Negative Going Threshold vs. Supply Voltage**



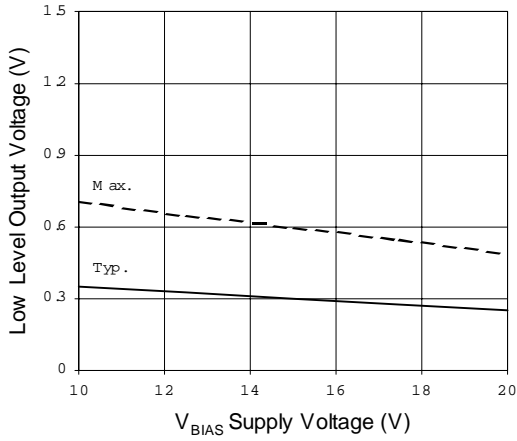
**Figure 16A. High Level Output Voltage vs. Temperature**



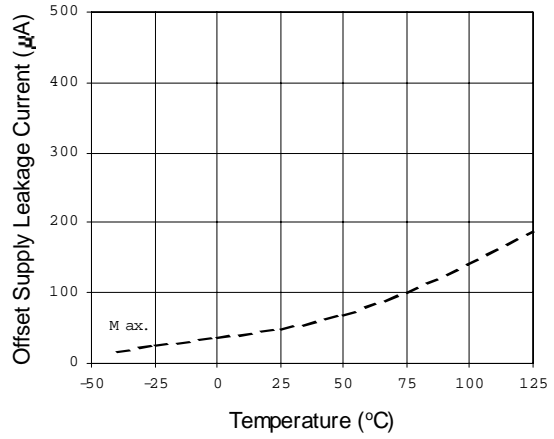
**Figure 16B. High Level Output Voltage vs. Supply Voltage**



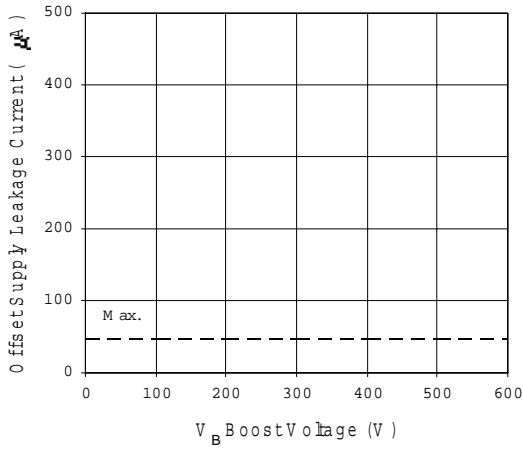
**Figure 17A. Low Level Output Voltage vs. Temperature**



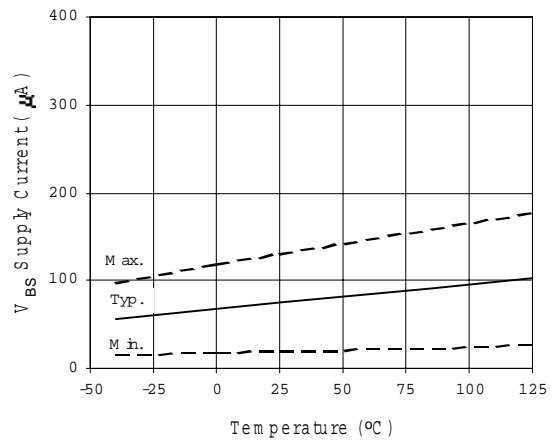
**Figure 17B. Low Level Output Voltage vs. Supply Voltage**



**Figure 18A. Offset Supply Leakage Current vs. Temperature**



**Figure 18B. Offset Supply Leakage Current vs. Boost Voltage**



**Figure 19A. V<sub>BS</sub> Supply Current vs. Temperature**

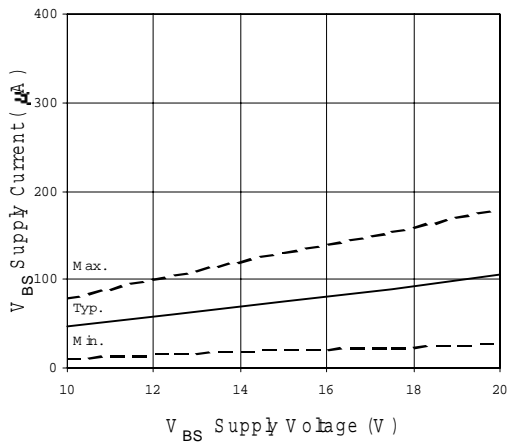


Figure 19B. V<sub>BS</sub> Supply Current vs. Supply Voltage

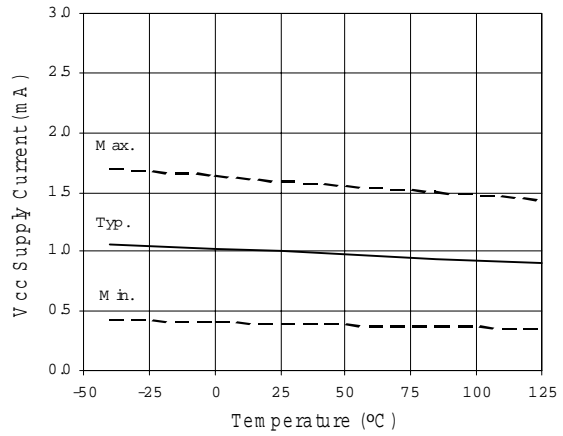


Figure 20A. V<sub>CC</sub> Supply Current vs. Temperature

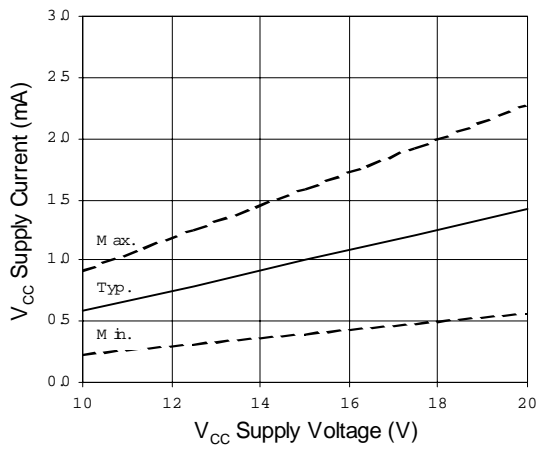


Figure 20B. V<sub>CC</sub> Supply Current vs. V<sub>CC</sub> Supply Voltage

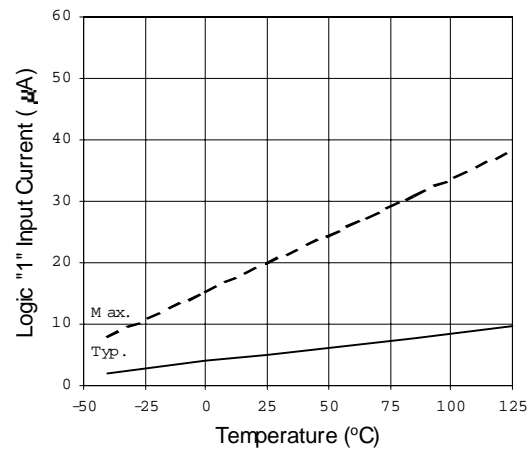
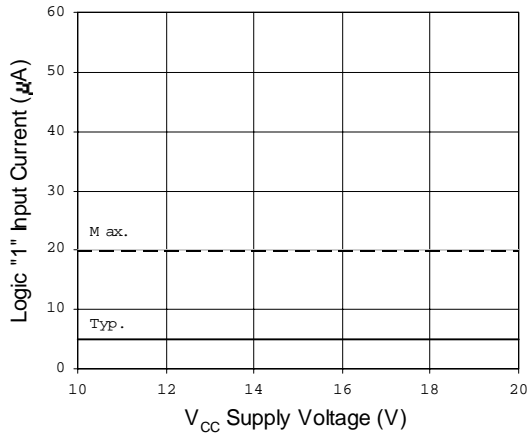
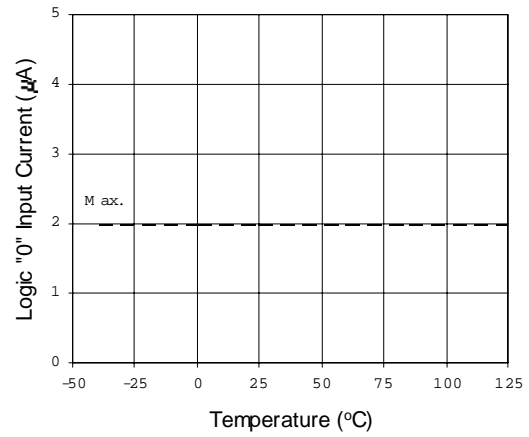


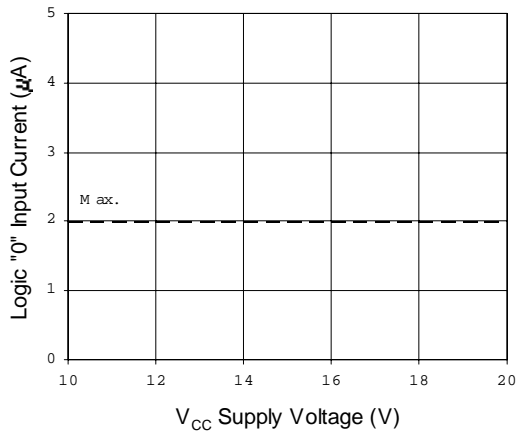
Figure 21A. Logic "1" Input Current vs. Temperature



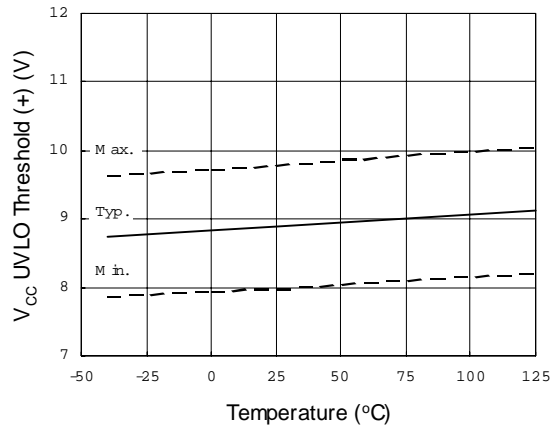
**Figure 21B. Logic "1" Input Current vs. Supply Voltage**



**Figure 22A. Logic "0" Input Current vs. Temperature**



**Figure 22B. Logic "0" Input Current vs. Supply Voltage**



**Figure 23. V<sub>CC</sub> Undervoltage Threshold (+) vs. Temperature**

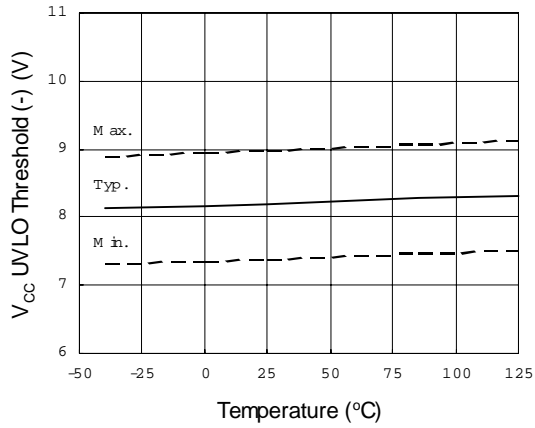


Figure 24.  $V_{CC}$  Undervoltage Threshold (-) vs. Temperature

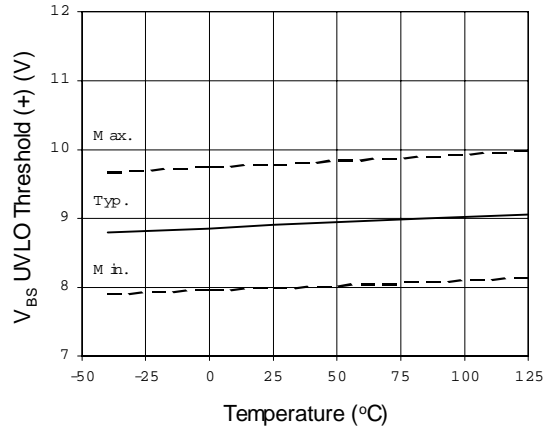


Figure 25.  $V_{BS}$  Undervoltage Threshold (+) vs. Temperature

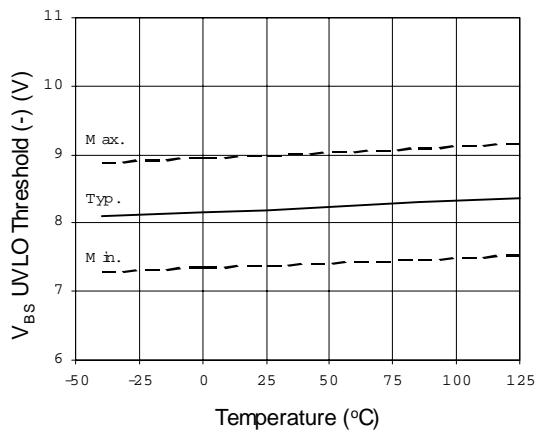


Figure 26.  $V_{BS}$  Undervoltage Threshold (-) vs. Temperature

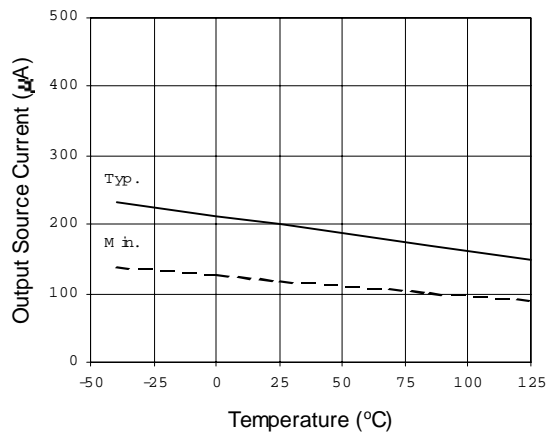


Figure 27A. Output Source Current vs. Temperature

# IR2109(4) (S)

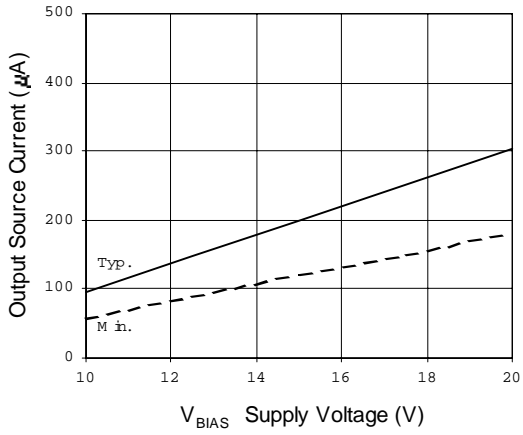


Figure 27B. Output Source Current vs. Supply Voltage

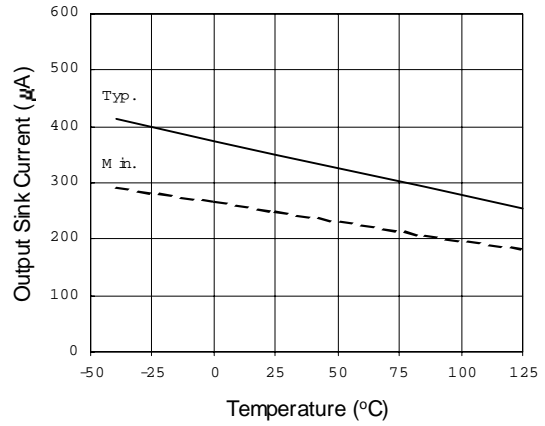


Figure 28A. Output Sink Current vs. Temperature

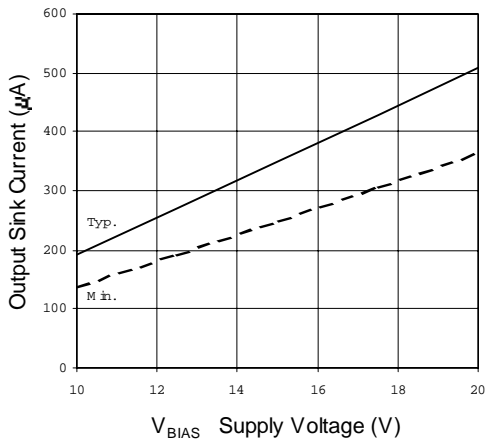


Figure 28B. Output Sink Current vs. Supply Voltage

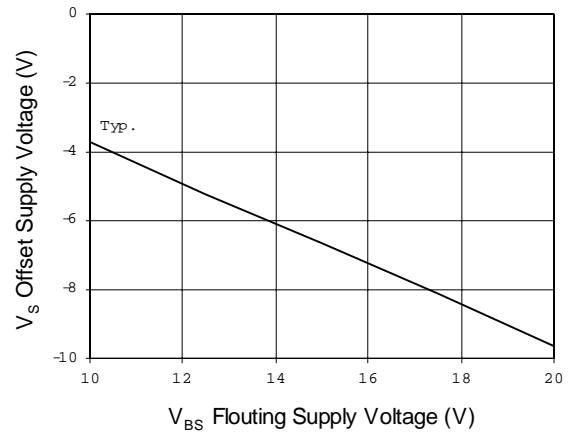


Figure 29. Maximum V<sub>S</sub> Negative Offset vs. Supply Voltage

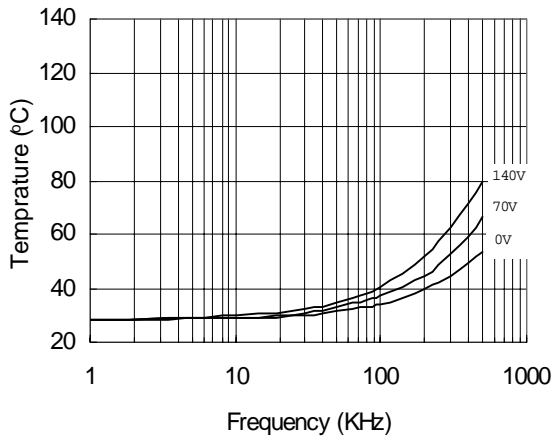


Figure 30. IR2109 vs Frequency (IRFBC20)  
Rgate = 33Ω, VCC = 15V

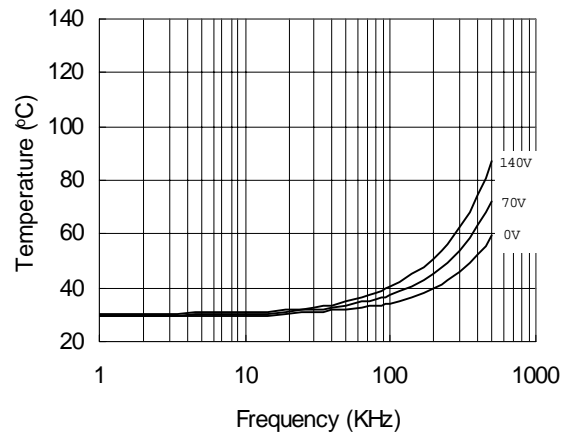


Figure 31. IR2109 vs Frequency (IRFBC30)  
Rgate = 22Ω, VCC = 15V

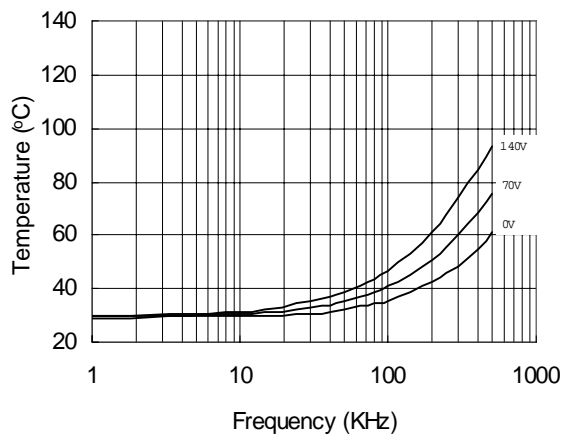


Figure 32. IR2109 vs Frequency (IRFBC40)  
Rgate = 15Ω, VCC = 15V

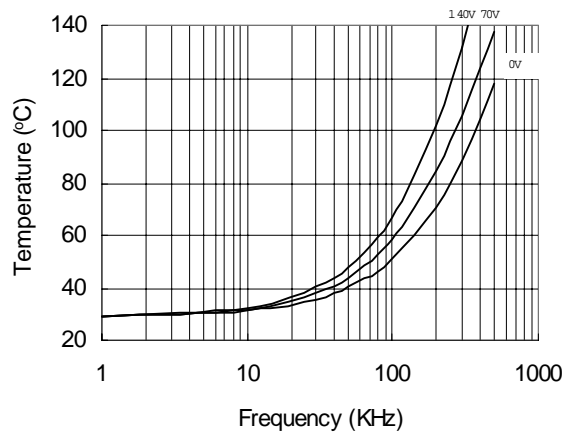


Figure 33. IR2109 vs Frequency (IRFPE50)  
Rgate = 10Ω, VCC = 15V

# IR2109(4) (s)

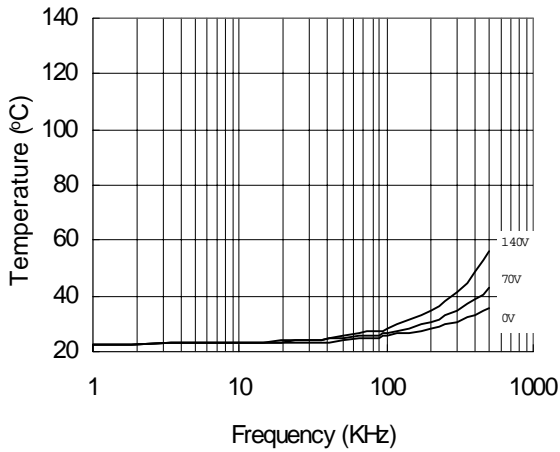


Figure 34. IR21094 vs. Frequency (IRFBC20),  
 $R_{gate}=33\Omega$ ,  $V_{CC}=15V$

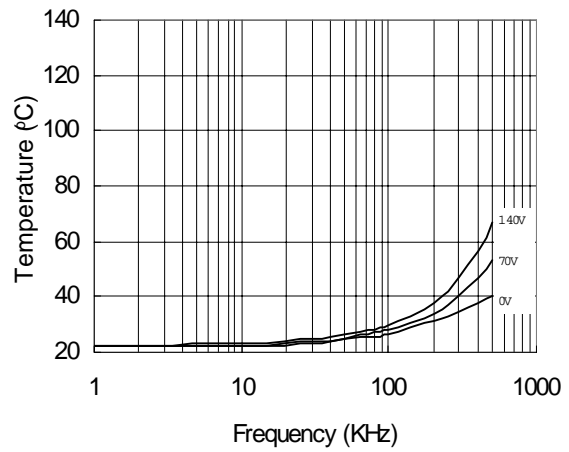


Figure 35. IR21094 vs. Frequency (IRFBC30),  
 $R_{gate}=22\Omega$ ,  $V_{CC}=15V$

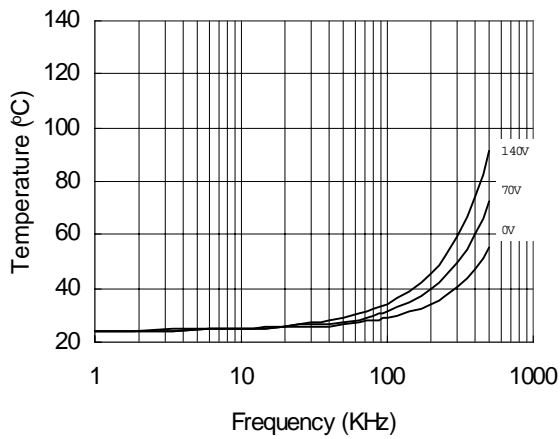


Figure 36. IR21094 vs. Frequency (IRFBC40),  
 $R_{gate}=15\Omega$ ,  $V_{CC}=15V$

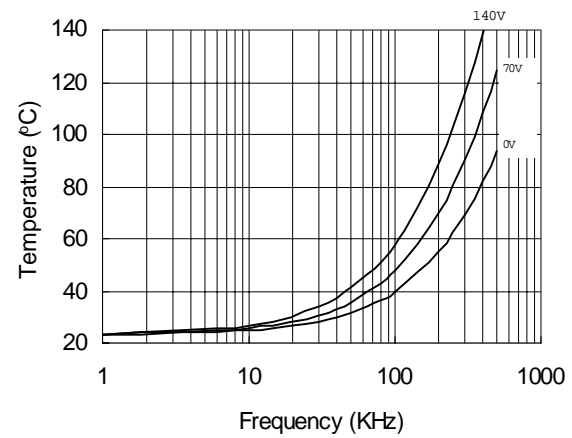


Figure 37. IR21094 vs. Frequency (IRFPE50),  
 $R_{gate}=10\Omega$ ,  $V_{CC}=15V$

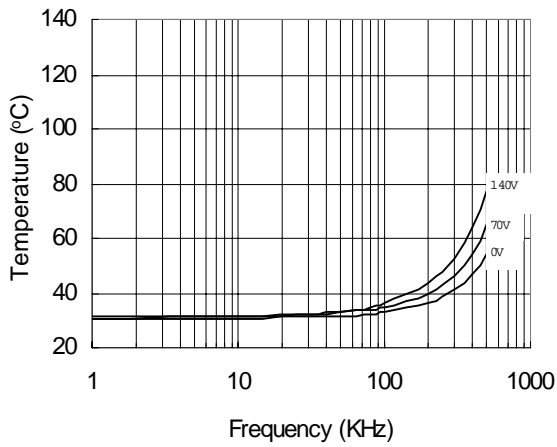


Figure 38. IR2109S vs. Frequency (IRFBC20),  
 $R_{gate}=33\Omega$ ,  $V_{CC}=15V$

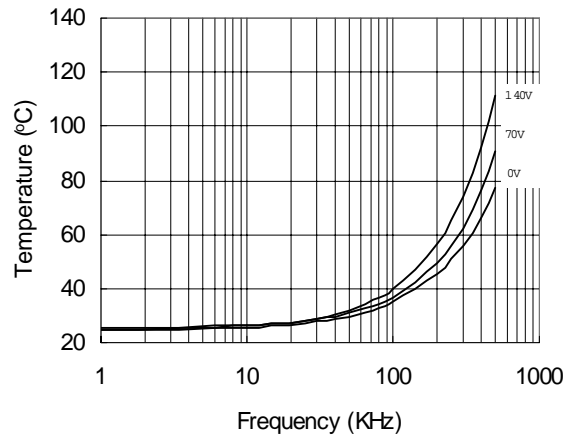


Figure 39. IR2109S vs. Frequency (IRFBC30),  
 $R_{gate}=22\Omega$ ,  $V_{CC}=15V$

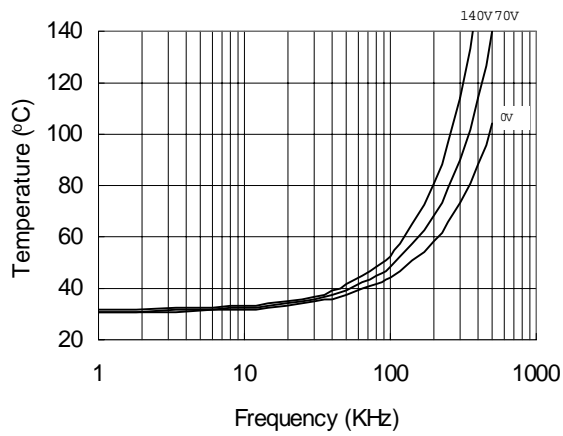


Figure 40. IR2109S vs. Frequency (IRFBC40),  
 $R_{gate}=15\Omega$ ,  $V_{CC}=15V$

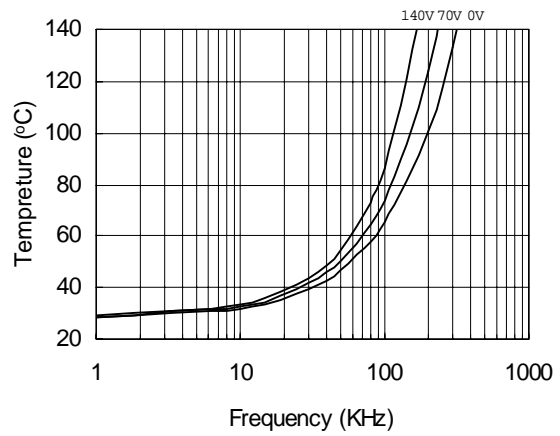


Figure 41. IR2109S vs. Frequency  
(IRFPE50),  $R_{gate}=10\Omega$ ,  $V_{CC}=15V$

# IR2109(4) (s)

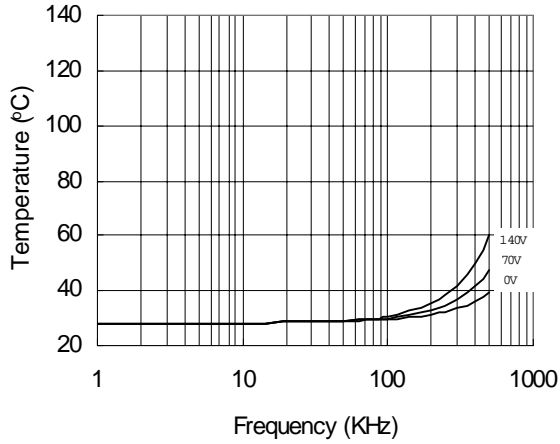


Figure 42. IR21094S vs. Frequency (IRFBC20),  
 $R_{gate}=33\Omega$ ,  $V_{CC}=15V$

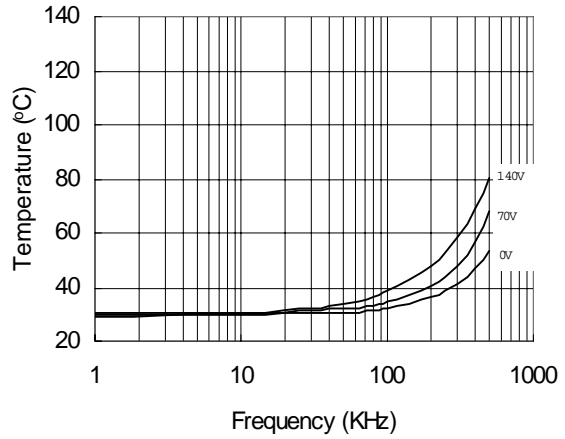


Figure 43. IR21094S vs. Frequency (IRFBC30),  
 $R_{gate}=22\Omega$ ,  $V_{CC}=15V$

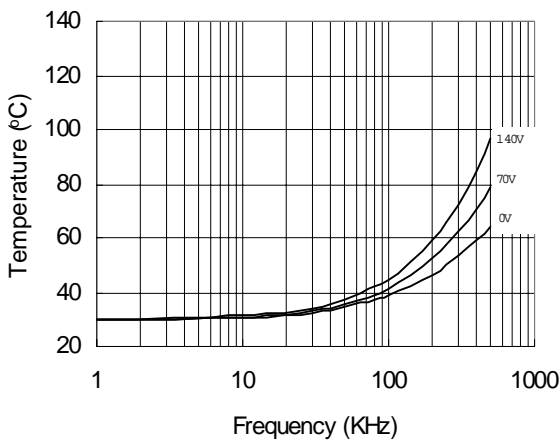


Figure 44. IR21094S vs. Frequency (IRFBC40),  
 $R_{gate}=15\Omega$ ,  $V_{CC}=15V$

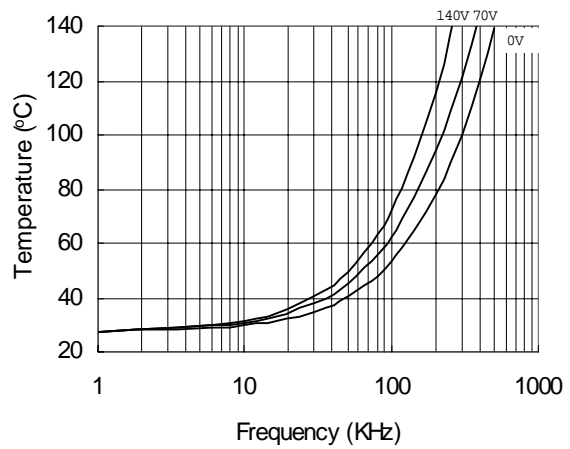
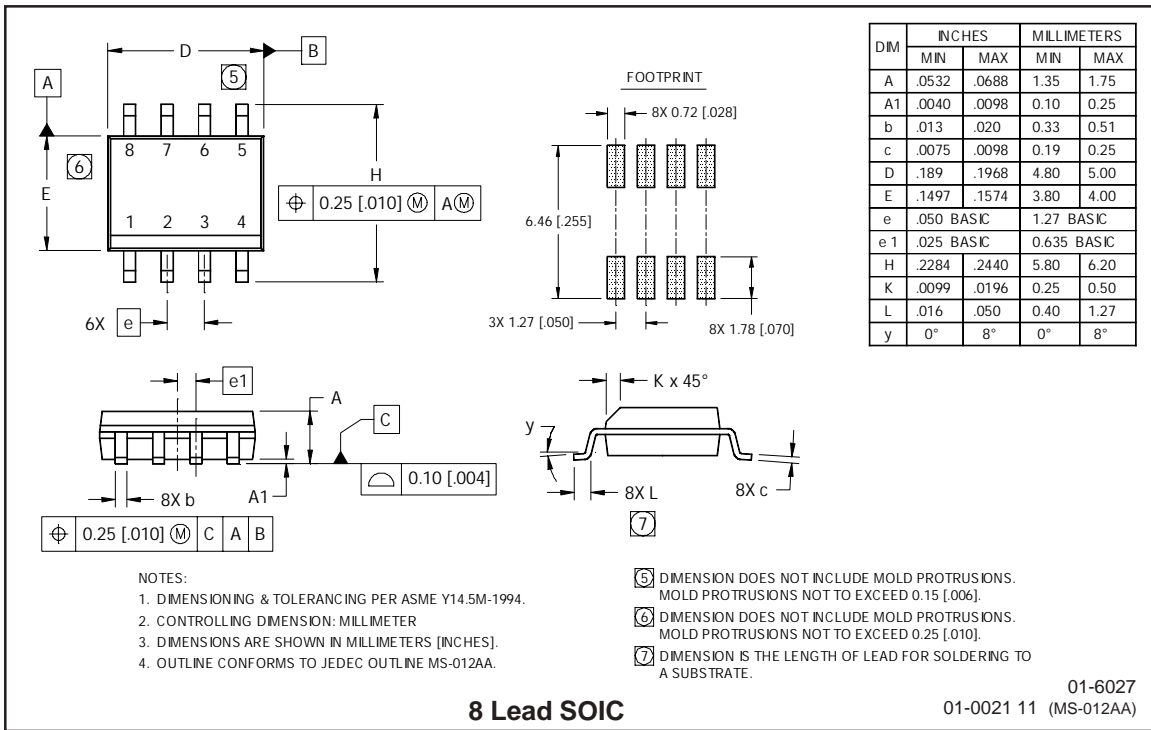
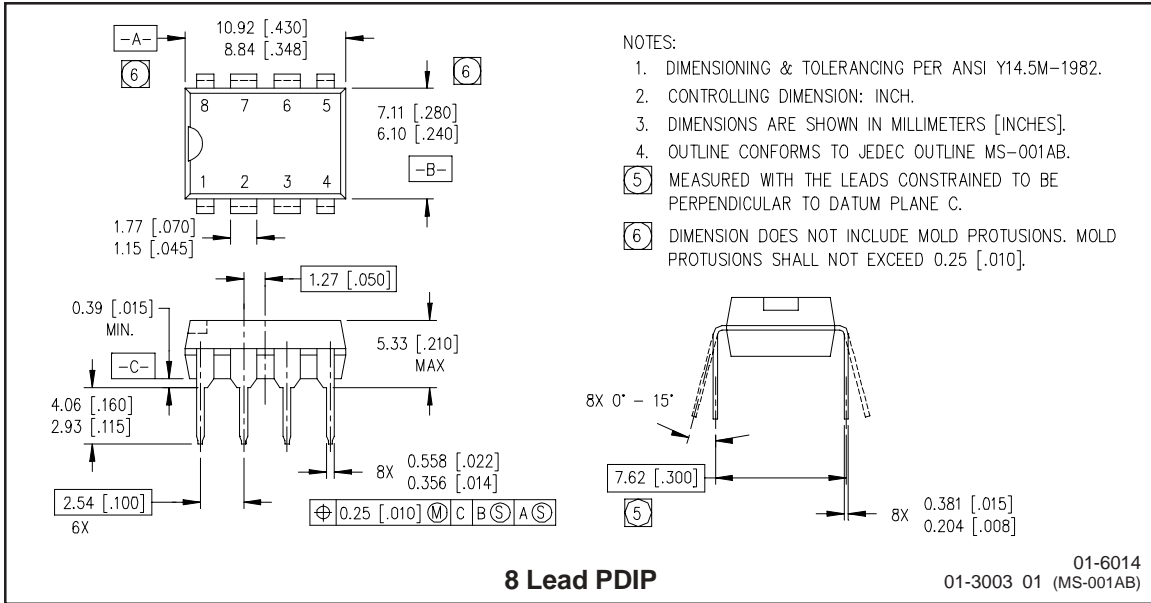


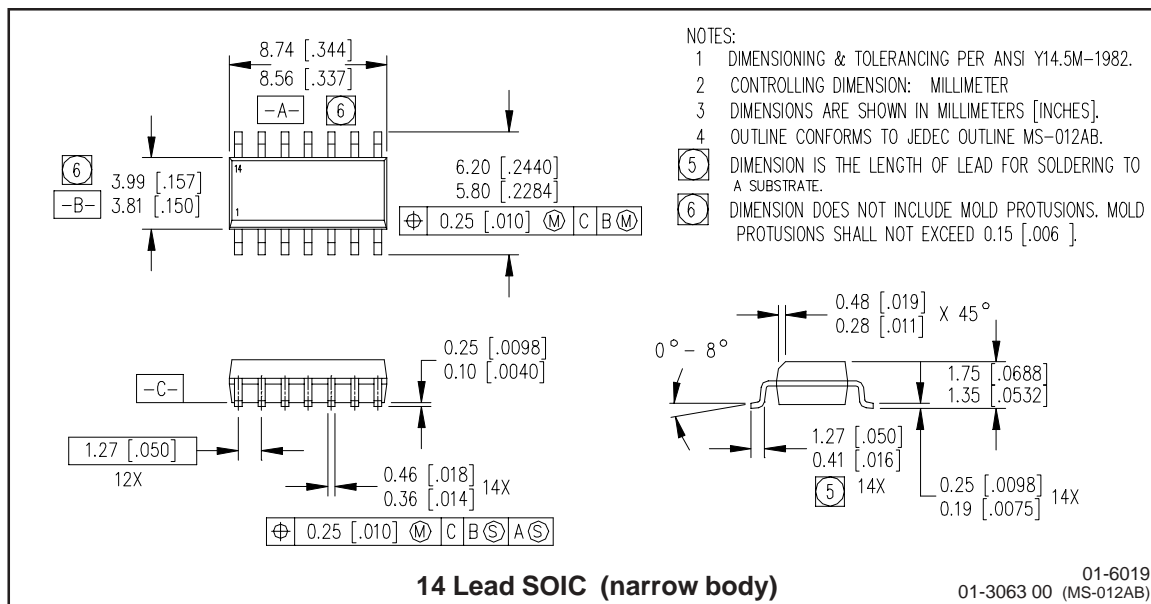
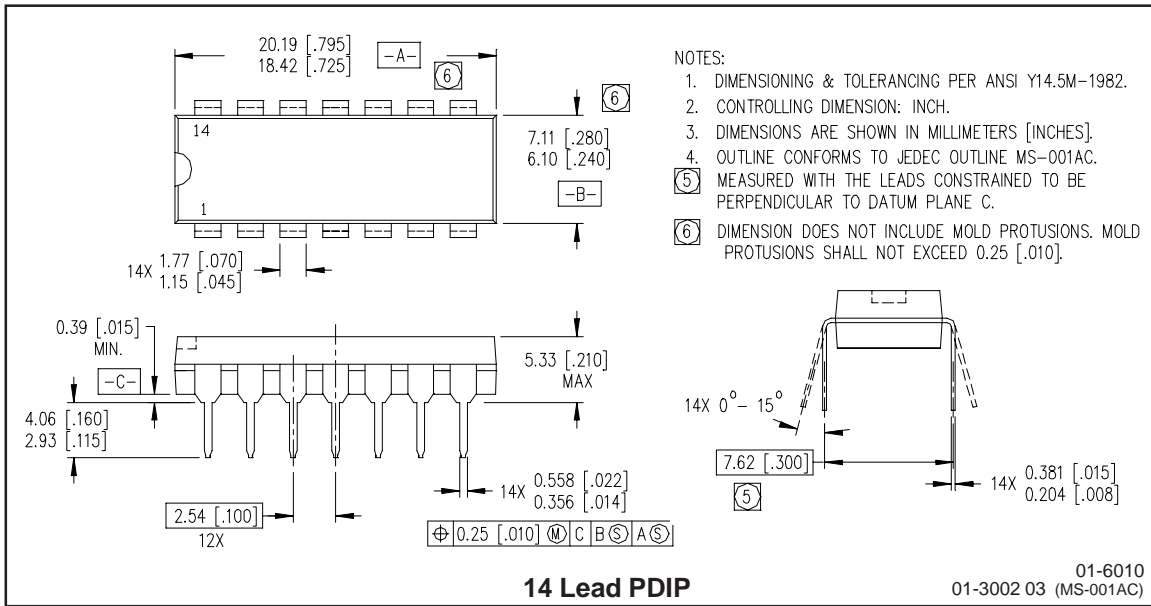
Figure 45. IR21094S vs. Frequency (IRFPE50),  
 $R_{gate}=10\Omega$ ,  $V_{CC}=15V$

## Case Outlines



# IR2109(4) (S)

International  
IR Rectifier



Data and specifications subject to change without notice. 7/11/2003



LittleDiode supplies new, hard to find or obsolete electronic components and semiconductors all over the world.

With over two million different components listed you are sure to find the part you need.

Feel free to visit us today at our online store:

[LittleDiode.com](http://LittleDiode.com)

Looking forward to providing you with the best possible service.