

HEXFET® Power MOSFET

INTERNATIONAL RECTIFIER 65E D

- Isolated Package
- High Voltage Isolation= 2.5KV RMS ⑤
- Sink to Lead Creepage Dist.= 4.8mm
- P-Channel
- 175°C Operating Temperature
- Dynamic dv/dt Rating
- Low Thermal Resistance

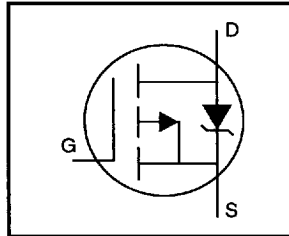

$$V_{DSS} = -60V$$

$$R_{DS(on)} = 0.14\Omega$$

$$I_D = -12A$$

Description

Third Generation HEXFETs from International Rectifier provide the designer with the best combination of fast switching, ruggedized device design, low on-resistance and cost-effectiveness.

The TO-220 Fullpak eliminates the need for additional insulating hardware in commercial-industrial applications. The moulding compound used provides a high isolation capability and a low thermal resistance between the tab and external heatsink. This isolation is equivalent to using a 100 micron mica barrier with standard TO-220 product. The Fullpak is mounted to a heatsink using a single clip or by a single screw fixing.

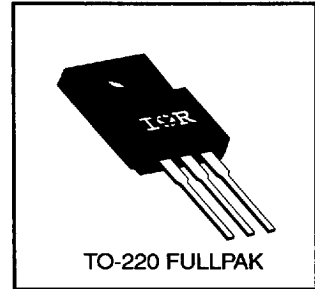

DATA SHEETS

Absolute Maximum Ratings

	Parameter	Max.	Units
$I_D @ T_C = 25^\circ C$	Continuous Drain Current, $V_{GS} @ -10 V$	-12	A
$I_D @ T_C = 100^\circ C$	Continuous Drain Current, $V_{GS} @ -10 V$	-8.5	
I_{DM}	Pulsed Drain Current ①	-48	
$P_D @ T_C = 25^\circ C$	Power Dissipation	42	W
	Linear Derating Factor	0.28	W/°C
V_{GS}	Gate-to-Source Voltage	± 20	V
E_{AS}	Single Pulse Avalanche Energy ②	370	mJ
I_{AR}	Avalanche Current ①	-12	A
E_{AR}	Repetitive Avalanche Energy ①	4.2	mJ
dv/dt	Peak Diode Recovery dv/dt ③	-4.5	V/ns
T_J T_{STG}	Operating Junction and Storage Temperature Range	-55 to +175	°C
	Soldering Temperature, for 10 seconds	300 (1.6mm from case)	
	Mounting Torque, 6-32 or M3 screw	10 lbf•in (1.1 N•m)	

Thermal Resistance

	Parameter	Min.	Typ.	Max.	Units
$R_{\theta JC}$	Junction-to-Case	—	—	3.6	°C/W
$R_{\theta JA}$	Junction-to-Ambient	—	—	65	

Electrical Characteristics @ T_J = 25°C (unless otherwise specified)

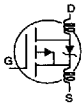
	Parameter	Min.	Typ.	Max.	Units	Test Conditions
V _{(BR)DSS}	Drain-to-Source Breakdown Voltage	-60	—	—	V	V _{GS} =0V, I _D =-250μA
ΔV _{(BR)DSS/ΔT_J}	Breakdown Voltage Temp. Coefficient	—	-0.060	—	V/°C	Reference to 25°C, I _D =-1mA
R _{DS(on)}	Static Drain-to-Source On-Resistance	—	—	0.14	Ω	V _{GS} =-10V, I _D =-7.2A ④
V _{GS(th)}	Gate Threshold Voltage	-2.0	—	-4.0	V	V _{DS} =V _{GS} , I _D =-250μA
g _{fs}	Forward Transconductance	5.4	—	—	S	V _{DS} =-25V, I _D =-7.2A ④
I _{DSS}	Drain-to-Source Leakage Current	—	—	-100	μA	V _{DS} =-60V, V _{GS} =0V
		—	—	-500		V _{DS} =-48V, V _{GS} =0V, T _J =150°C
I _{GSS}	Gate-to-Source Forward Leakage	—	—	-100	nA	V _{GS} =-20V
	Gate-to-Source Reverse Leakage	—	—	100		V _{GS} =20V
Q _g	Total Gate Charge	—	—	34	nC	I _D =-18A
Q _{gs}	Gate-to-Source Charge	—	—	9.9		V _{DS} =-48V
Q _{gd}	Gate-to-Drain ("Miller") Charge	—	—	16		V _{GS} =-10V See Fig. 6 and 13 ④
t _{d(on)}	Turn-On Delay Time	—	18	—	ns	V _{DD} =-30V
t _r	Rise Time	—	120	—		I _D =-18A
t _{d(off)}	Turn-Off Delay Time	—	20	—		R _G =12Ω
t _f	Fall Time	—	58	—		R _D =1.5Ω See Figure 10 ④
L _D	Internal Drain Inductance	—	4.5	—	nH	Between lead, 6 mm (0.25in.) from package and center of die contact
L _S	Internal Source Inductance	—	7.5	—		
C _{iss}	Input Capacitance	—	1100	—	pF	V _{GS} =0V
C _{oss}	Output Capacitance	—	620	—		V _{DS} =-25V
C _{rss}	Reverse Transfer Capacitance	—	100	—		f=1.0MHz See Figure 5
C	Drain to Sink Capacitance	—	12	—		f=1.0MHz

Source-Drain Ratings and Characteristics

	Parameter	Min.	Typ.	Max.	Units	Test Conditions
I _S	Continuous Source Current (Body Diode)	—	—	-12	A	MOSFET symbol showing the integral reverse p-n junction diode.
I _{SM}	Pulsed Source Current (Body Diode) ①	—	—	-48		
V _{SD}	Diode Forward Voltage	—	—	-6.3	V	T _J =25°C, I _S =-12A, V _{GS} =0V ④
t _{rr}	Reverse Recovery Time	—	100	200	ns	T _J =25°C, I _F =-18A
Q _{rr}	Reverse Recovery Charge	—	0.28	0.52	μC	di/dt=100A/μs ④
t _{on}	Forward Turn-On Time	Intrinsic turn-on time is negligible (turn-on is dominated by L _S +L _D)				

Notes:

① Repetitive rating; pulse width limited by max. junction temperature (See Figure 11)

 ③ I_{SD}≤-12A, di/dt≤170A/μs, V_{DD}≤V_{(BR)DSS}, T_J≤175°C

⑤ t=60s, f=60Hz

 ② V_{DD}=-25V, starting T_J=25°C, L=3.0mH R_G=25Ω, I_{AS}=-12A (See Figure 12)

④ Pulse width ≤ 300 μs; duty cycle ≤2%.

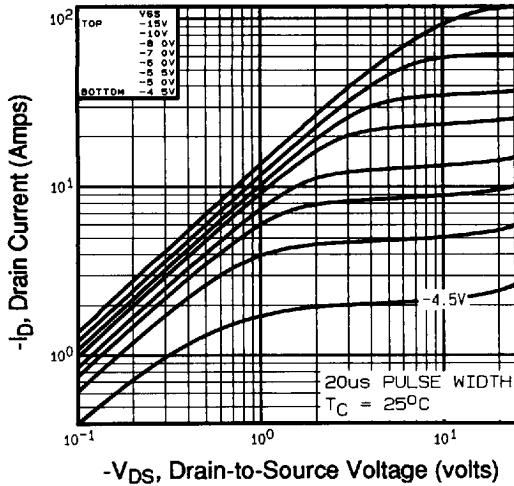
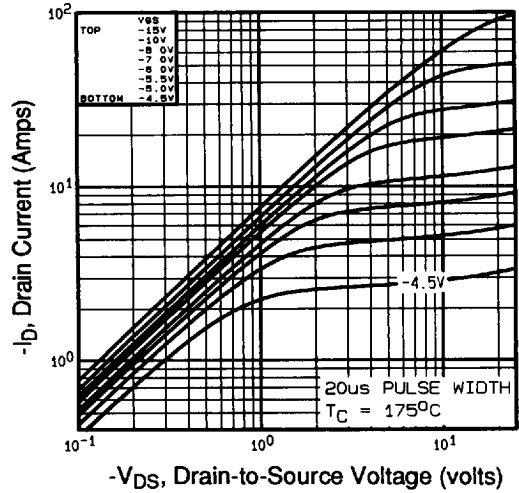
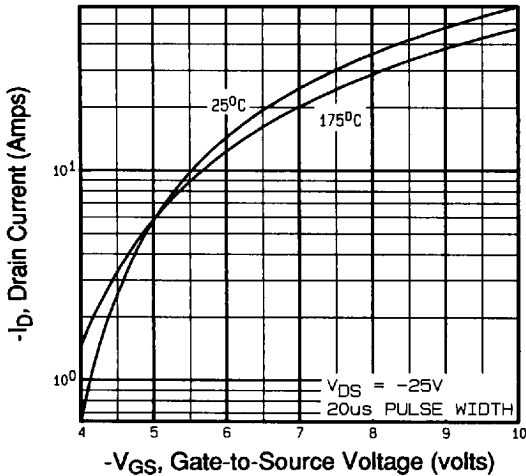
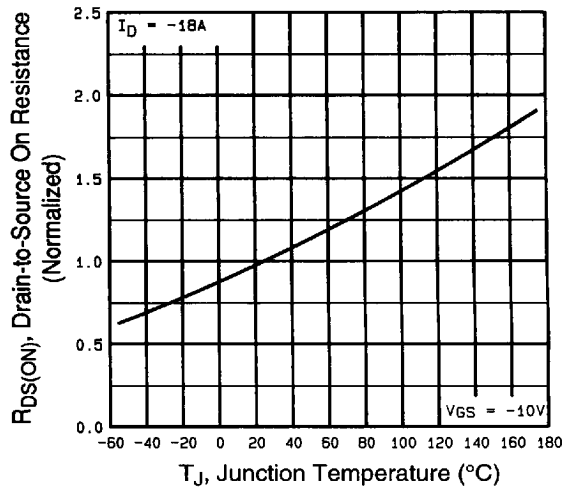
Fig 1. Typical Output Characteristics, $T_C=25^\circ\text{C}$

Fig 2. Typical Output Characteristics, $T_C=175^\circ\text{C}$

Fig 3. Typical Transfer Characteristics

Fig 4. Normalized On-Resistance Vs. Temperature

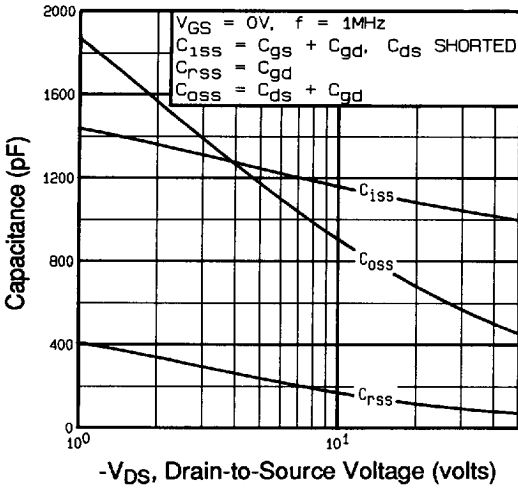

Fig 5. Typical Capacitance Vs. Drain-to-Source Voltage

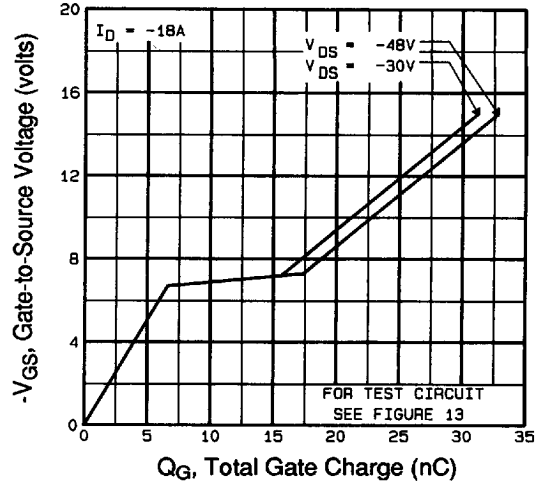

Fig 6. Typical Gate Charge Vs. Gate-to-Source Voltage

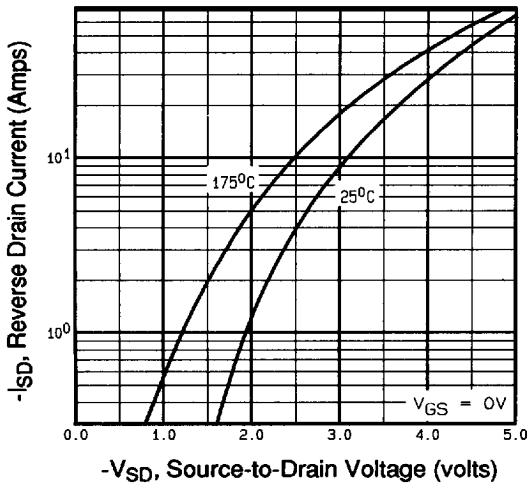

Fig 7. Typical Source-Drain Diode Forward Voltage

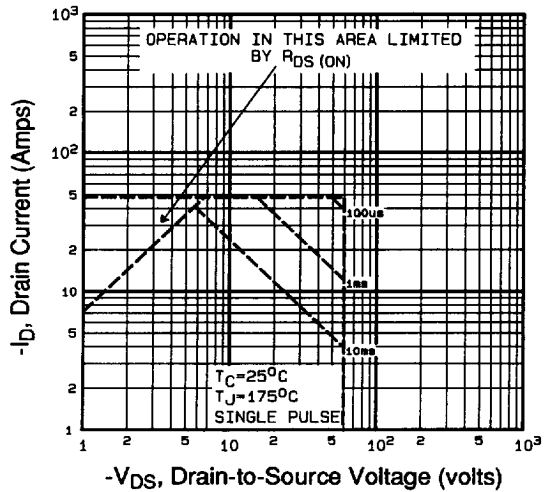

Fig 8. Maximum Safe Operating Area

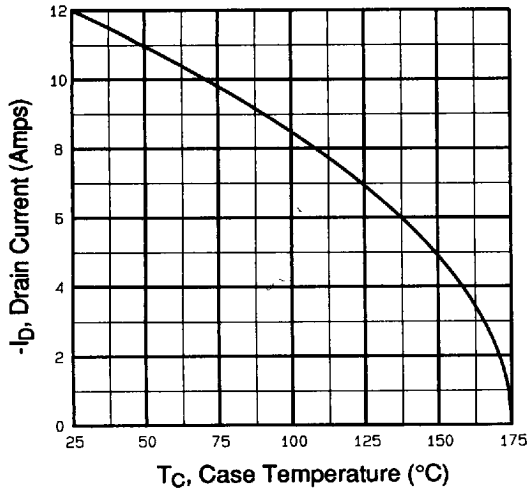

Fig 9. Maximum Drain Current Vs. Case Temperature

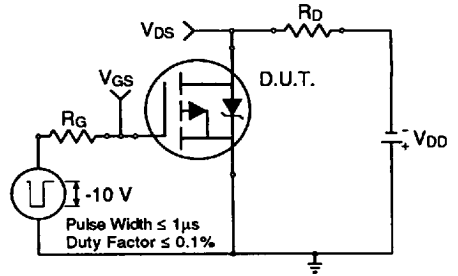

Fig 10a. Switching Time Test Circuit

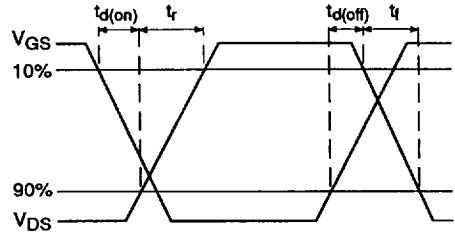

Fig 10b. Switching Time Waveforms

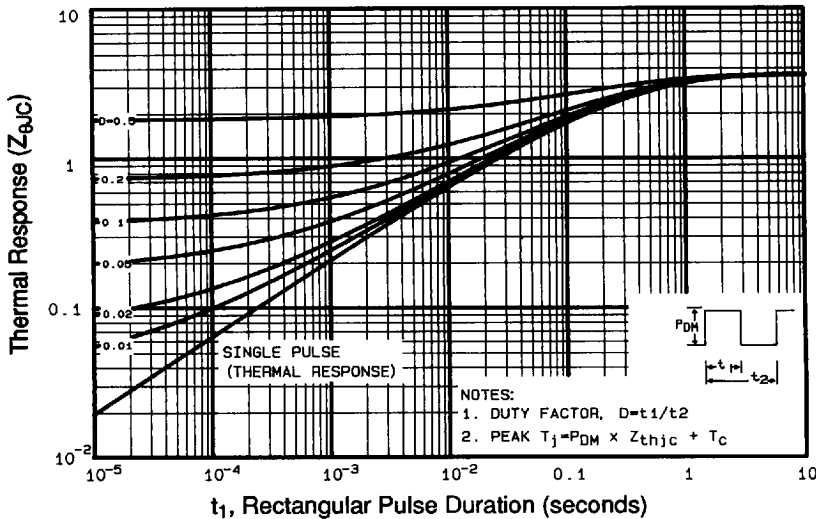

Fig 11. Maximum Effective Transient Thermal Impedance, Junction-to-Case

DATA SHEETS

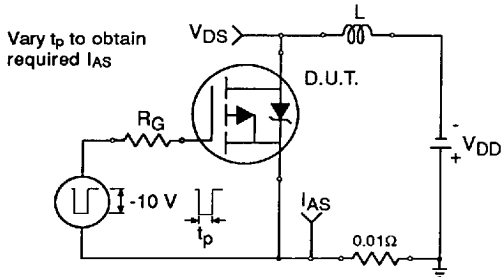

Fig 12a. Unclamped Inductive Test Circuit

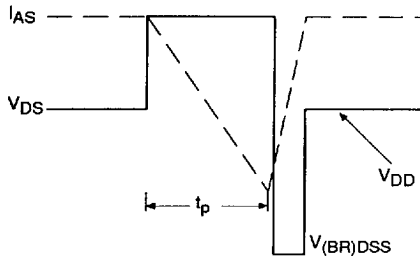

Fig 12b. Unclamped Inductive Waveforms

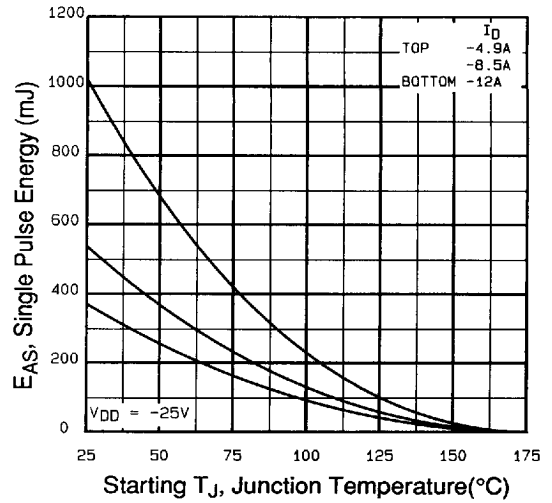

Fig 12c. Maximum Avalanche Energy Vs. Drain Current

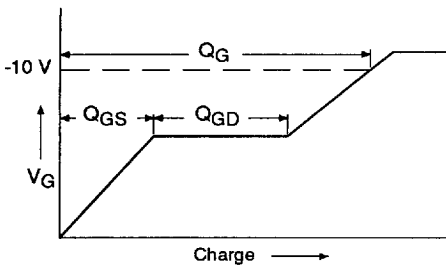

Fig 13a. Basic Gate Charge Waveform

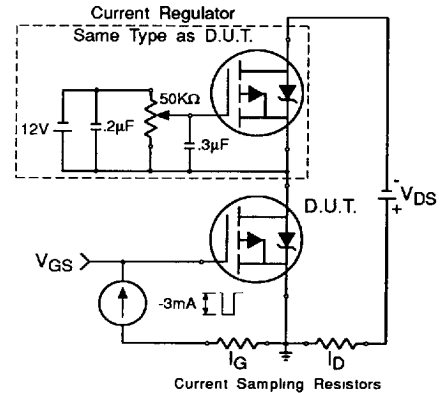

Fig 13b. Gate Charge Test Circuit

Appendix A: Figure 14, Peak Diode Recovery dv/dt Test Circuit – See page 1506

Appendix B: Package Outline Mechanical Drawing – See page 1510

Appendix C: Part Marking Information – See page 1517

International Rectifier