

Features

- Switching-loss rating includes all "tail" losses
- HEXFRED™ soft ultrafast diodes
- Optimized for high operating frequency (over 5kHz)
See Fig. 1 for Current vs. Frequency curve

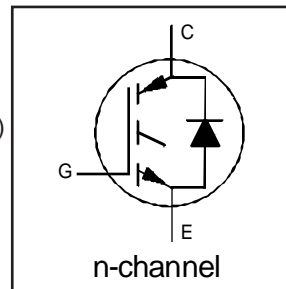

$V_{CES} = 600V$

$V_{CE(sat)} \leq 3.0V$

@ $V_{GE} = 15V, I_C = 12A$

Description

Co-packaged IGBTs are a natural extension of International Rectifier's well known IGBT line. They provide the convenience of an IGBT and an ultrafast recovery diode in one package, resulting in substantial benefits to a host of high-voltage, high-current, motor control, UPS and power supply applications.

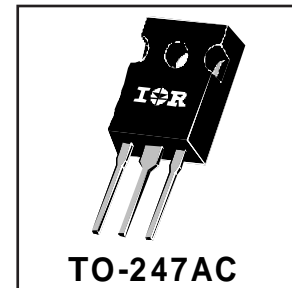

Absolute Maximum Ratings

	Parameter	Max.	Units
V_{CES}	Collector-to-Emitter Voltage	600	V
$I_C @ T_C = 25^\circ C$	Continuous Collector Current	23	A
$I_C @ T_C = 100^\circ C$	Continuous Collector Current	12	
I_{CM}	Pulsed Collector Current ①	92	
I_{LM}	Clamped Inductive Load Current ②	92	
$I_F @ T_C = 100^\circ C$	Diode Continuous Forward Current	12	
I_{FM}	Diode Maximum Forward Current	92	
V_{GE}	Gate-to-Emitter Voltage	± 20	V
$P_D @ T_C = 25^\circ C$	Maximum Power Dissipation	100	W
$P_D @ T_C = 100^\circ C$	Maximum Power Dissipation	42	
T_J	Operating Junction and Storage Temperature Range	-55 to +150	°C
T_{STG}			
	Mounting Torque, 6-32 or M3 Screw.	10 lbf•in (1.1 N•m)	

Thermal Resistance

	Parameter	Min.	Typ.	Max.	Units
$R_{\theta JC}$	Junction-to-Case - IGBT	-----	-----	1.2	°C/W
$R_{\theta JC}$	Junction-to-Case - Diode	-----	-----	2.5	
$R_{\theta CS}$	Case-to-Sink, flat, greased surface	-----	0.24	-----	
$R_{\theta JA}$	Junction-to-Ambient, typical socket mount	-----	-----	40	
Wt	Weight	-----	6 (0.21)	-----	g (oz)

IRGPC30UD2



Electrical Characteristics @ T_J = 25°C (unless otherwise specified)

	Parameter	Min.	Typ.	Max.	Units	Conditions
V _{(BR)CES}	Collector-to-Emitter Breakdown Voltage ^③	600	----	----	V	V _{GE} = 0V, I _C = 250μA
ΔV _{(BR)CES/ΔT_J}	Temperature Coeff. of Breakdown Voltage	----	0.63	----	V/°C	V _{GE} = 0V, I _C = 1.0mA
V _{CE(on)}	Collector-to-Emitter Saturation Voltage	----	2.2	3.0	V	I _C = 12A V _{GE} = 15V
		----	2.7	----		I _C = 23A See Fig. 2, 5
		----	2.4	----		I _C = 12A, T _J = 150°C
V _{GE(th)}	Gate Threshold Voltage	3.0	----	5.5		V _{CE} = V _{GE} , I _C = 250μA
ΔV _{GE(th)/ΔT_J}	Temperature Coeff. of Threshold Voltage	----	-11	----	mV/°C	V _{CE} = V _{GE} , I _C = 250μA
g _{fe}	Forward Transconductance ^④	3.1	8.6	----	S	V _{CE} = 100V, I _C = 12A
I _{CES}	Zero Gate Voltage Collector Current	----	----	250	μA	V _{GE} = 0V, V _{CE} = 600V
		----	----	2500		V _{GE} = 0V, V _{CE} = 600V, T _J = 150°C
V _{FM}	Diode Forward Voltage Drop	----	1.4	1.7	V	I _C = 12A See Fig. 13
		----	1.3	1.6		I _C = 12A, T _J = 150°C
I _{GES}	Gate-to-Emitter Leakage Current	----	----	±100	nA	V _{GE} = ±20V

Switching Characteristics @ T_J = 25°C (unless otherwise specified)

	Parameter	Min.	Typ.	Max.	Units	Conditions	
Q _g	Total Gate Charge (turn-on)	----	29	36	nC	I _C = 12A	
Q _{ge}	Gate - Emitter Charge (turn-on)	----	4.8	6.8		V _{CC} = 400V	
Q _{gc}	Gate - Collector Charge (turn-on)	----	12	17		See Fig. 8	
t _{d(on)}	Turn-On Delay Time	----	67	----	ns	T _J = 25°C	
t _r	Rise Time	----	56	----		I _C = 12A, V _{CC} = 480V	
t _{d(off)}	Turn-Off Delay Time	----	170	250		V _{GE} = 15V, R _G = 23Ω	
t _f	Fall Time	----	140	270	mJ	Energy losses include "tail" and diode reverse recovery.	
E _{on}	Turn-On Switching Loss	----	0.70	----		See Fig. 9, 10, 11, 18	
E _{off}	Turn-Off Switching Loss	----	0.80	----			
E _{ts}	Total Switching Loss	----	1.5	2.5	mJ	T _J = 150°C, See Fig. 9, 10, 11, 18	
t _{d(on)}	Turn-On Delay Time	----	61	----			ns
t _r	Rise Time	----	51	----			
t _{d(off)}	Turn-Off Delay Time	----	190	----	V _{GE} = 15V, R _G = 23Ω		
t _f	Fall Time	----	190	----	mJ	Energy losses include "tail" and diode reverse recovery.	
E _{ts}	Total Switching Loss	----	1.9	----			
L _E	Internal Emitter Inductance	----	13	----	nH	Measured 5mm from package	
C _{ies}	Input Capacitance	----	680	----	pF	V _{GE} = 0V	
C _{oes}	Output Capacitance	----	110	----		V _{CC} = 30V See Fig. 7	
C _{res}	Reverse Transfer Capacitance	----	11	----		f = 1.0MHz	
t _{rr}	Diode Reverse Recovery Time	----	42	60	ns	T _J = 25°C See Fig.	
		----	80	120		T _J = 125°C 14	
I _{rr}	Diode Peak Reverse Recovery Current	----	3.5	6.0	A	T _J = 25°C See Fig.	
		----	5.6	10		T _J = 125°C 15	
Q _{rr}	Diode Reverse Recovery Charge	----	80	180	nC	T _J = 25°C See Fig.	
		----	220	600		T _J = 125°C 16	
μs	A/μs	d _(rec) /dt	Diode Peak Rate of Fall of Recovery	----	----	180	
				T _J = 25°C See Fig.		During t _b	120

Notes:

- ① Repetitive rating; V_{GE}=20V, pulse width limited by max. junction temperature. (See fig. 20)
- ② V_{CC}=80%(V_{CES}), V_{GE}=20V, L=10μH, R_G = 23Ω, (See fig. 19)
- ③ Pulse width ≤ 80μs; duty factor ≤ 0.1%.
- ④ Pulse width 5.0μs, single shot.

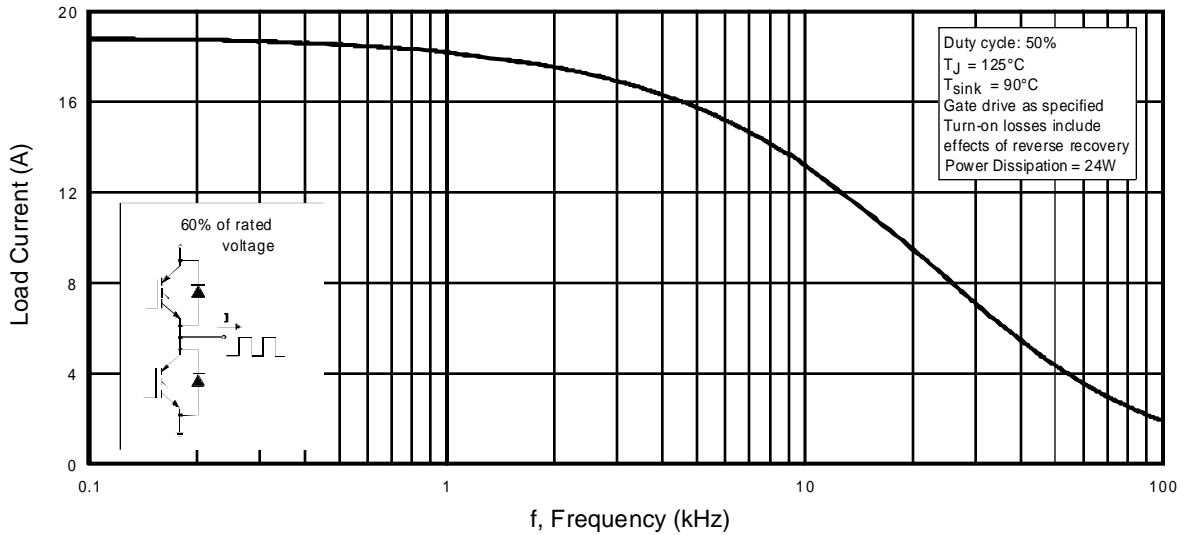

Fig. 1 - Typical Load Current vs. Frequency
(Load Current = I_{RMS} of fundamental)

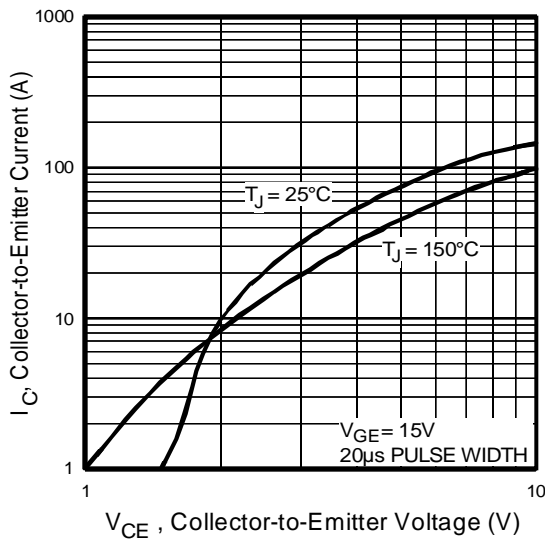

Fig. 2 - Typical Output Characteristics

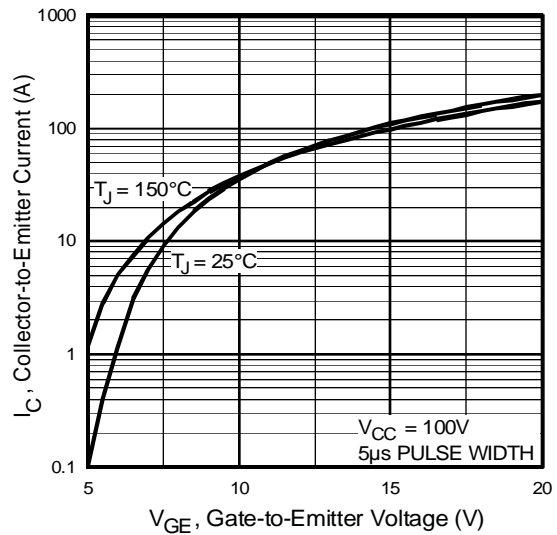

Fig. 3 - Typical Transfer Characteristics

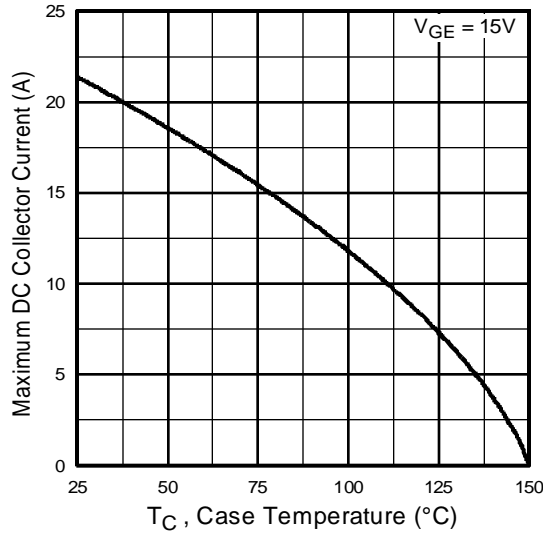

Fig. 4 - Maximum Collector Current vs. Case Temperature

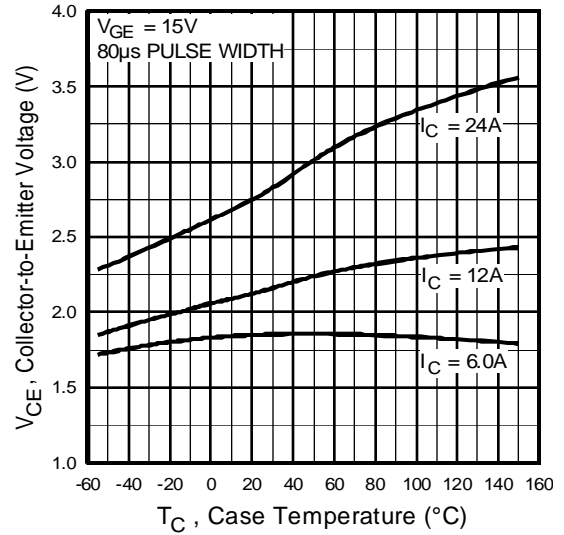

Fig. 5 - Collector-to-Emitter Voltage vs. Case Temperature

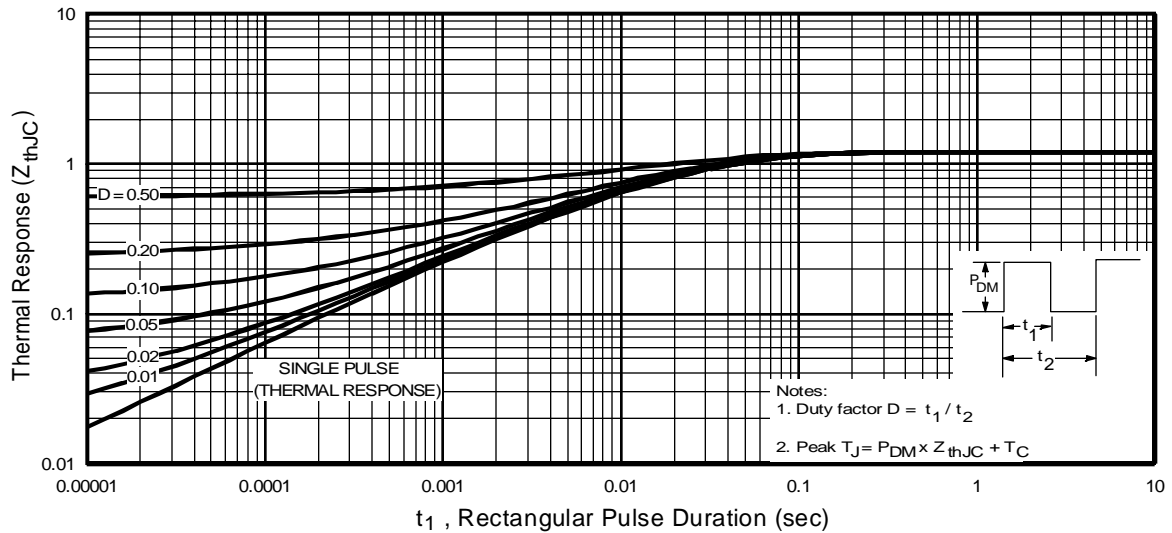

Fig. 6 - Maximum IGBT Effective Transient Thermal Impedance, Junction-to-Case

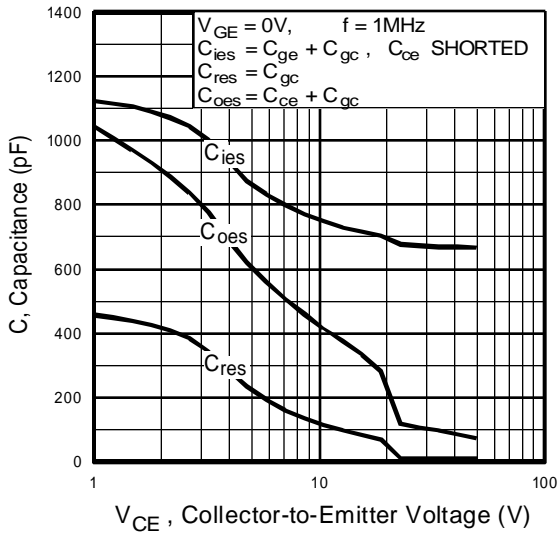

Fig. 7 - Typical Capacitance vs. Collector-to-Emitter Voltage

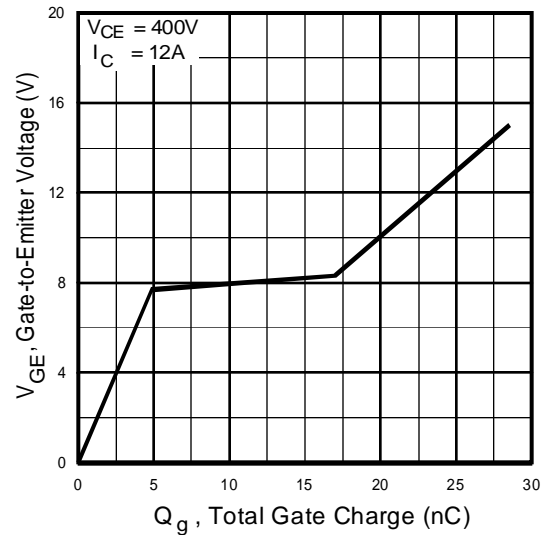

Fig. 8 - Typical Gate Charge vs. Gate-to-Emitter Voltage

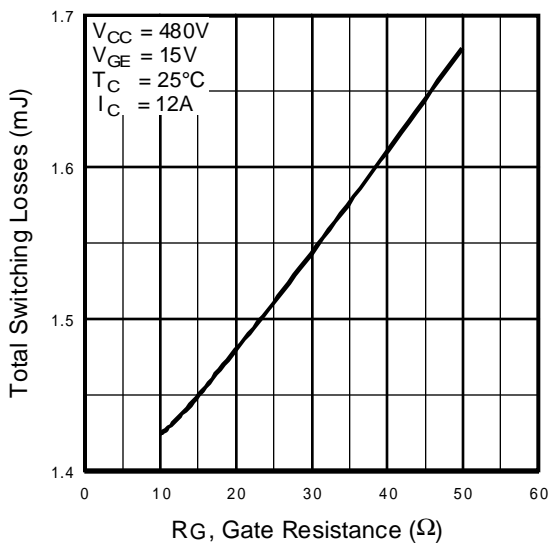

Fig. 9 - Typical Switching Losses vs. Gate Resistance

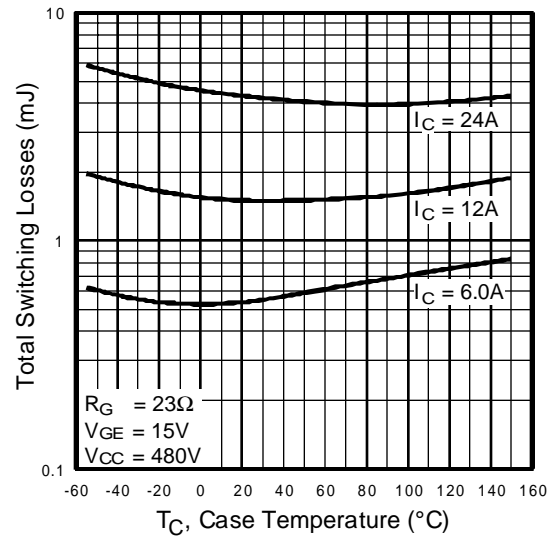

Fig. 10 - Typical Switching Losses vs. Case Temperature

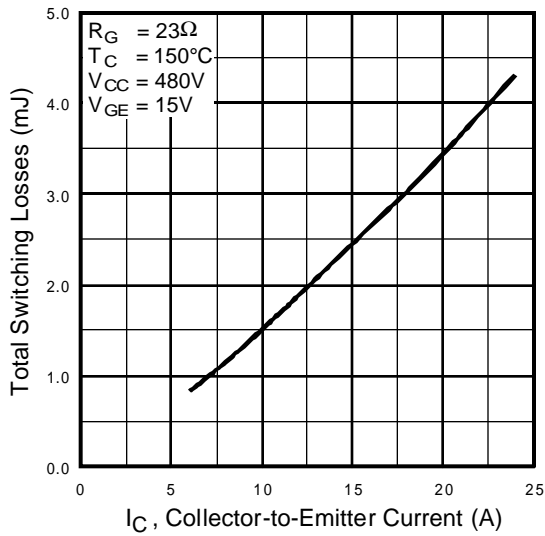

Fig. 11 - Typical Switching Losses vs. Collector-to-Emitter Current

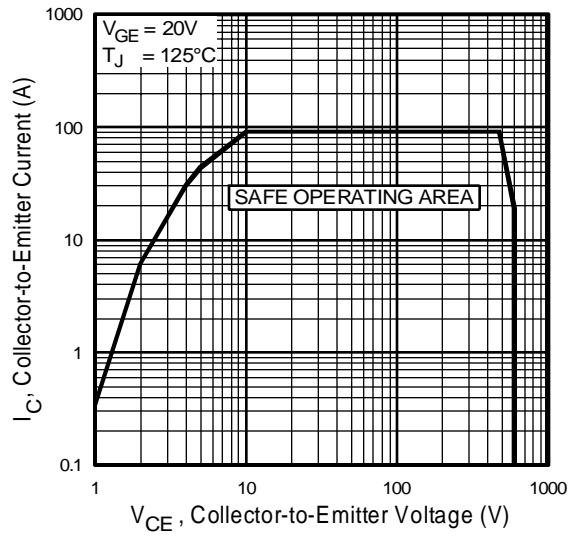

Fig. 12 - Turn-Off SOA

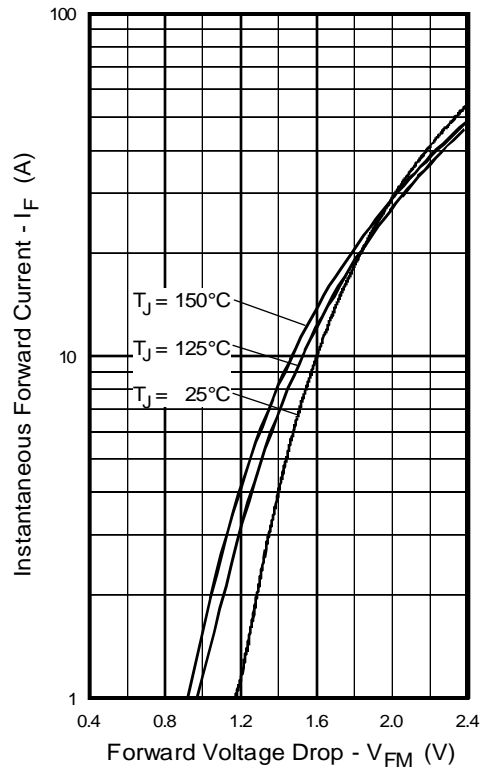

Fig. 13 - Maximum Forward Voltage Drop vs. Instantaneous Forward Current

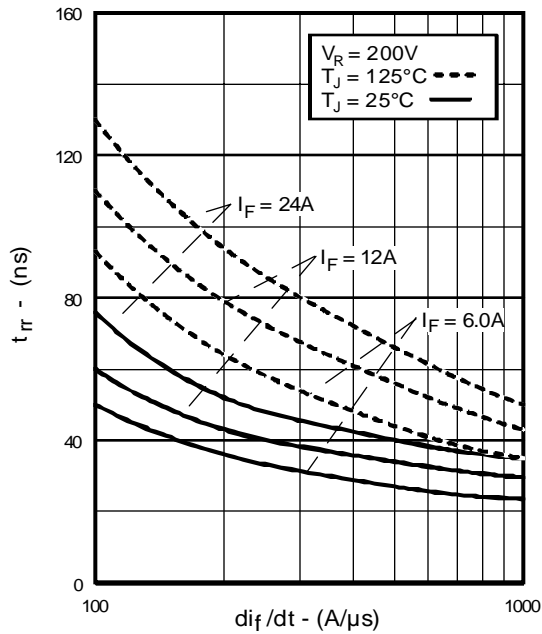

Fig. 14 - Typical Reverse Recovery vs. di_f/dt

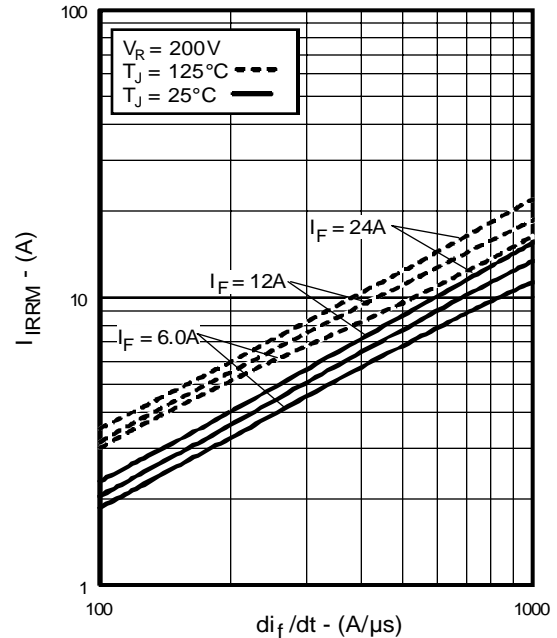

Fig. 15 - Typical Recovery Current vs. di_f/dt

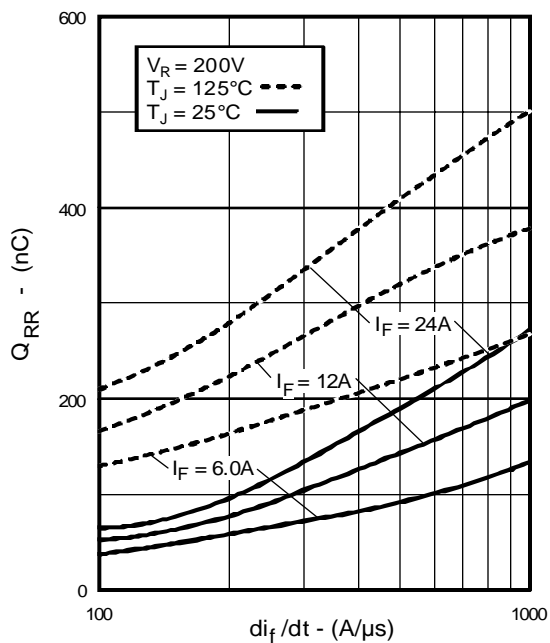

Fig. 16 - Typical Stored Charge vs. di_f/dt

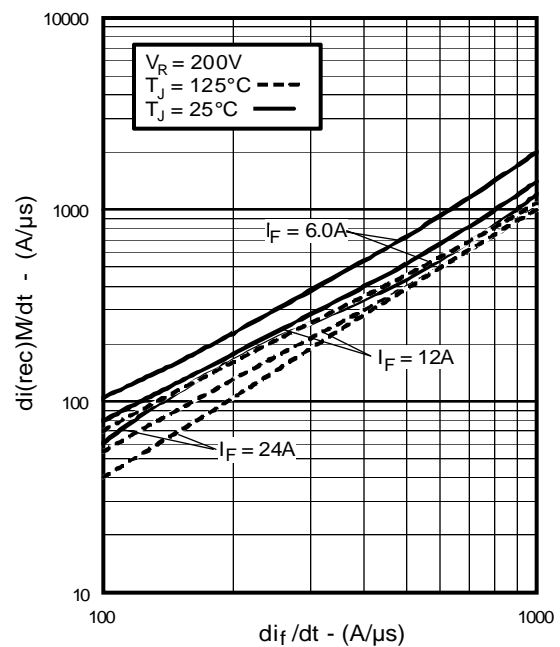

Fig. 17 - Typical $di_{(rec)M}/dt$ vs. di_f/dt

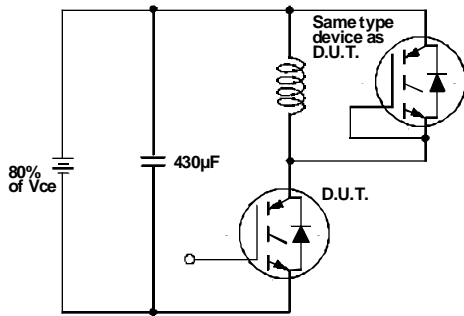

Fig. 18a - Test Circuit for Measurement of I_{LM} , E_{on} , $E_{off}(\text{diode})$, t_{rr} , Q_{rr} , I_{rr} , $t_{d(on)}$, t_r , $t_{d(off)}$, t_f

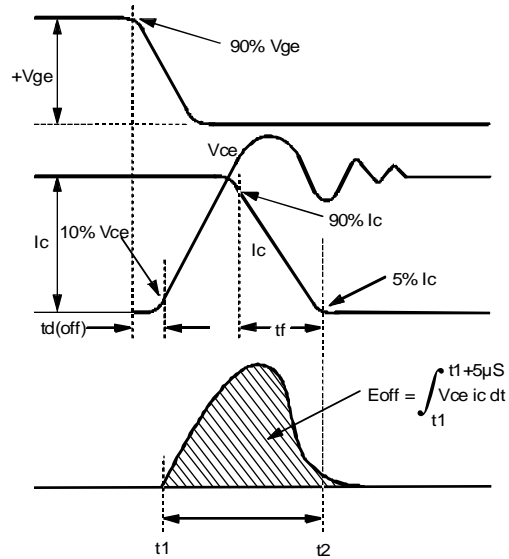

Fig. 18b - Test Waveforms for Circuit of Fig. 18a, Defining E_{off} , $t_{d(off)}$, t_f

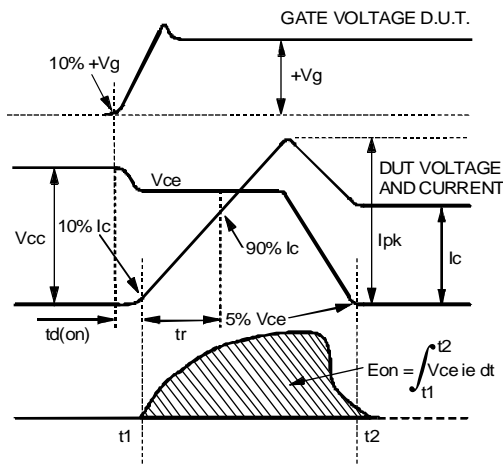

Fig. 18c - Test Waveforms for Circuit of Fig. 18a, Defining E_{on} , $t_{d(on)}$, t_r

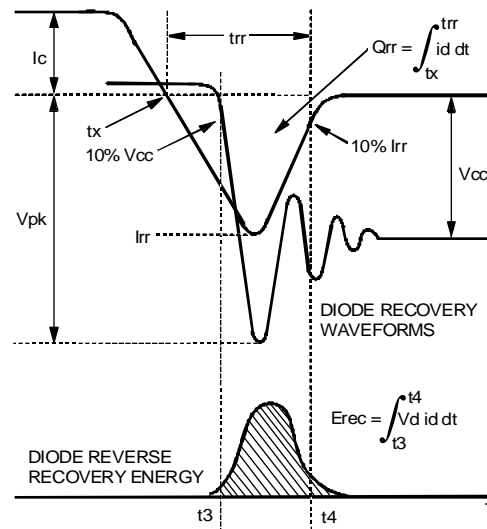

Fig. 18d - Test Waveforms for Circuit of Fig. 18a, Defining E_{rec} , t_{rr} , Q_{rr} , I_{rr}



IRGPC30UD2

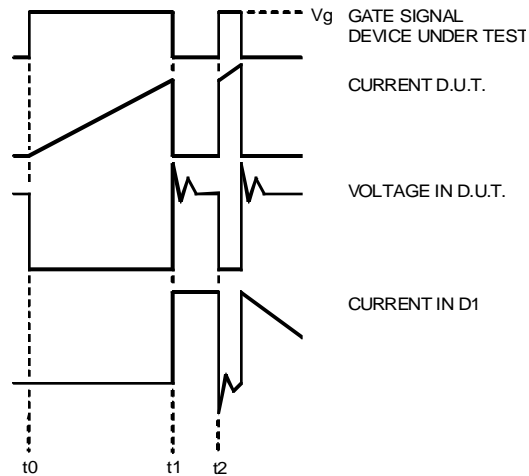

Fig. 18e - Macro Waveforms for Test Circuit of Fig. 18a

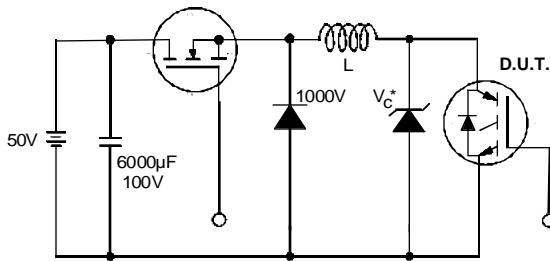

Fig. 19 - Clamped Inductive Load Test Circuit

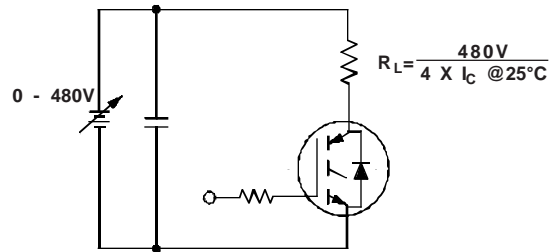
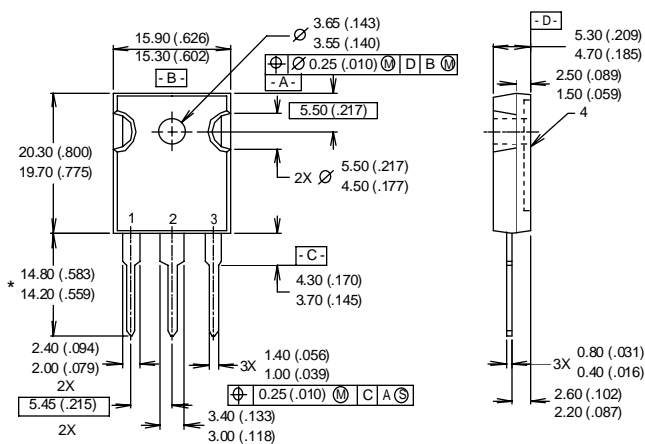

Fig. 20 - Pulsed Collector Current Test Circuit



- NOTES:
- 1 DIMENSIONS & TOLERANCING PER ANSI Y14.5M, 1982.
 - 2 CONTROLLING DIMENSION: INCH.
 - 3 DIMENSIONS ARE SHOWN MILLIMETERS (INCHES).
 - 4 CONFORMS TO JEDEC OUTLINE TO-247AC.

- LEAD ASSIGNMENTS
- 1 - GATE
 - 2 - COLLECTOR
 - 3 - EMITTER
 - 4 - COLLECTOR

* LONGER LEADED (20mm) VERSION AVAILABLE (TO-247AD) TO ORDER ADD "E" SUFFIX TO PART NUMBER

CONFORMS TO JEDEC OUTLINE TO-247AC (TO-3P)
Dimensions in Millimeters and (Inches)



LittleDiode supplies new, hard to find or obsolete electronic components and semiconductors all over the world.

With over two million different components listed you are sure to find the part you need.

Feel free to visit us today at our online store:

LittleDiode.com

Looking forward to providing you with the best possible service.