

ISL9K8120P3

8A, 1200V Stealth™ Dual Diode

General Description

The ISL9K8120P3 is a Stealth™ dual diode optimized for low loss performance in high frequency hard switched applications. The Stealth™ family exhibits low reverse recovery current ($I_{RM(REC)}$) and exceptionally soft recovery under typical operating conditions.

This device is intended for use as a free wheeling or boost diode in power supplies and other power switching applications. The low $I_{RM(REC)}$ and short t_a phase reduce loss in switching transistors. The soft recovery minimizes ringing, expanding the range of conditions under which the diode may be operated without the use of additional snubber circuitry. Consider using the Stealth™ diode with a 1200V NPT IGBT to provide the most efficient and highest power density design at lower cost.

Formerly developmental type TA49413.

Features

- Soft Recovery $t_b / t_a > 5.5$
- Fast Recovery $t_{rr} < 32ns$
- Operating Temperature 150°C
- Reverse Voltage 1200V
- Avalanche Energy Rated

Applications

- Switch Mode Power Supplies
- Hard Switched PFC Boost Diode
- UPS Free Wheeling Diode
- Motor Drive FWD
- SMPS FWD
- Snubber Diode

Package

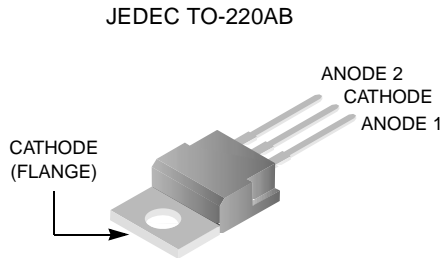

Symbol

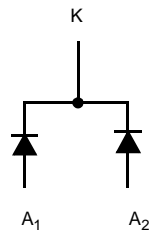

Device Maximum Ratings (per leg) $T_C = 25^\circ\text{C}$ unless otherwise noted

Symbol	Parameter	Ratings	Units
V_{RRM}	Repetitive Peak Reverse Voltage	1200	V
V_{RWM}	Working Peak Reverse Voltage	1200	V
V_R	DC Blocking Voltage	1200	V
$I_{F(AV)}$	Average Rectified Forward Current ($T_C = 105^\circ\text{C}$) Total Device Current (Both Legs)	8 16	A A
I_{FRM}	Repetitive Peak Surge Current (20kHz Square Wave)	16	A
I_{FSM}	Nonrepetitive Peak Surge Current (Halfwave 1 Phase 60Hz)	100	A
P_D	Power Dissipation	71	W
E_{AVL}	Avalanche Energy (1A, 40mH)	20	mJ
T_J, T_{STG}	Operating and Storage Temperature Range	-55 to 150	°C
T_L T_{PKG}	Maximum Temperature for Soldering Leads at 0.063in (1.6mm) from Case for 10s Package Body for 10s, See Application Note AN-7528	300 260	°C °C

CAUTION: Stresses above those listed in "Absolute Maximum Ratings" may cause permanent damage to the device. This is a stress only rating and operation of the device at these or any other conditions above those indicated in the operational sections of this specification is not implied.

Package Marking and Ordering Information

Device Marking	Device	Package	Tape Width	Quantity
K8120P3	ISL9K8120P3	TO-220AB	N/A	50

Electrical Characteristics (per leg) $T_C = 25^\circ\text{C}$ unless otherwise noted

Symbol	Parameter	Test Conditions	Min	Typ	Max	Units
--------	-----------	-----------------	-----	-----	-----	-------

Off State Characteristics

I_R	Instantaneous Reverse Current	$V_R = 1200\text{V}$	$T_C = 25^\circ\text{C}$	-	-	100	μA
			$T_C = 125^\circ\text{C}$	-	-	1.0	mA

On State Characteristics

V_F	Instantaneous Forward Voltage	$I_F = 8\text{A}$	$T_C = 25^\circ\text{C}$	-	2.8	3.3	V
			$T_C = 125^\circ\text{C}$	-	2.7	3.1	V

Dynamic Characteristics

C_J	Junction Capacitance	$V_R = 10\text{V}, I_F = 0\text{A}$	-	30	-	pF
-------	----------------------	-------------------------------------	---	----	---	-------------

Switching Characteristics

t_{rr}	Reverse Recovery Time	$I_F = 1\text{A}, di_F/dt = 100\text{A}/\mu\text{s}, V_R = 30\text{V}$	-	25	32	ns
		$I_F = 8\text{A}, di_F/dt = 100\text{A}/\mu\text{s}, V_R = 30\text{V}$	-	35	44	ns
t_{rr}	Reverse Recovery Time	$I_F = 8\text{A}, di_F/dt = 200\text{A}/\mu\text{s}, V_R = 780\text{V}, T_C = 25^\circ\text{C}$	-	300	-	ns
$I_{RM(REC)}$	Maximum Reverse Recovery Current		-	4.3	-	A
Q_{RR}	Reverse Recovered Charge		-	525	-	nC
t_{rr}	Reverse Recovery Time	$I_F = 8\text{A}, di_F/dt = 200\text{A}/\mu\text{s}, V_R = 780\text{V}, T_C = 125^\circ\text{C}$	-	375	-	ns
S	Softness Factor (t_b/t_a)		-	9	-	-
$I_{RM(REC)}$	Maximum Reverse Recovery Current		-	5.5	-	A
Q_{RR}	Reverse Recovered Charge		-	1.1	-	μC
t_{rr}	Reverse Recovery Time	$I_F = 8\text{A}, di_F/dt = 1000\text{A}/\mu\text{s}, V_R = 780\text{V}, T_C = 125^\circ\text{C}$	-	200	-	ns
S	Softness Factor (t_b/t_a)		-	5.5	-	-
$I_{RM(REC)}$	Maximum Reverse Recovery Current		-	11	-	A
Q_{RR}	Reverse Recovered Charge		-	1.2	-	μC
di_M/dt	Maximum di/dt during t_b		-	310	-	$\text{A}/\mu\text{s}$

Thermal Characteristics

$R_{\theta JC}$	Thermal Resistance Junction to Case	TO-220	-	-	1.75	$^\circ\text{C}/\text{W}$
$R_{\theta JA}$	Thermal Resistance Junction to Ambient	TO-220	-	-	62	$^\circ\text{C}/\text{W}$

Typical Performance Curves (per leg)

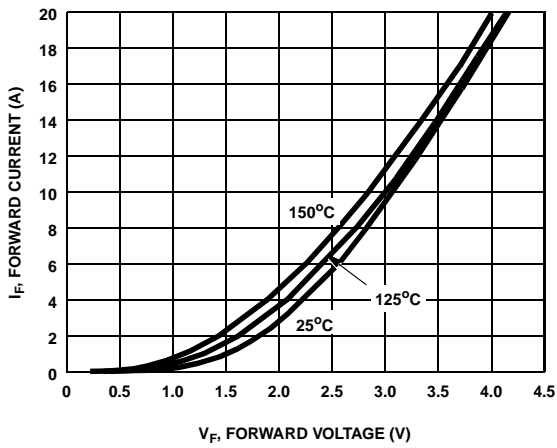

Figure 1. Forward Current vs Forward Voltage

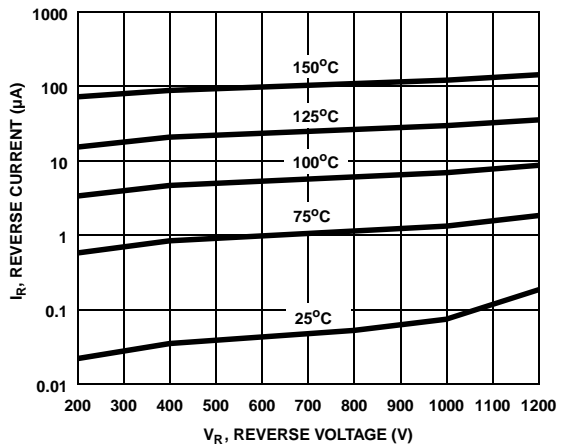

Figure 2. Reverse Current vs Reverse Voltage

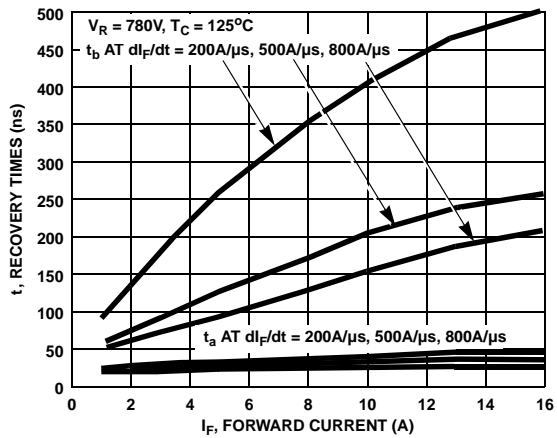

Figure 3. t_a and t_b Curves vs Forward Current

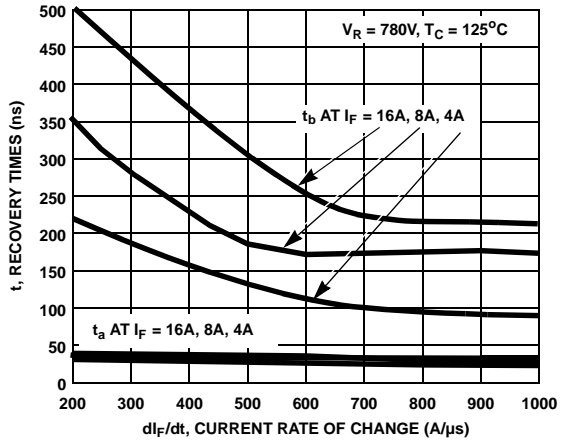

Figure 4. t_a and t_b Curves vs di_F/dt

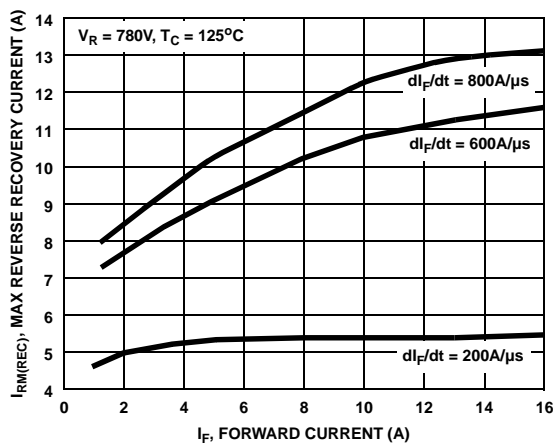

Figure 5. Maximum Reverse Recovery Current vs Forward Current

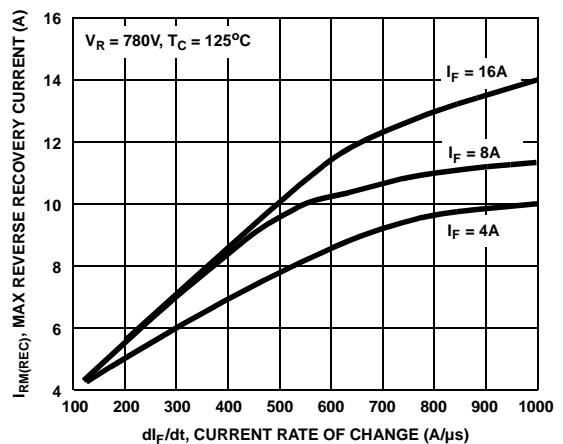

Figure 6. Maximum Reverse Recovery Current vs di_F/dt

Typical Performance Curves (per leg) (Continued)

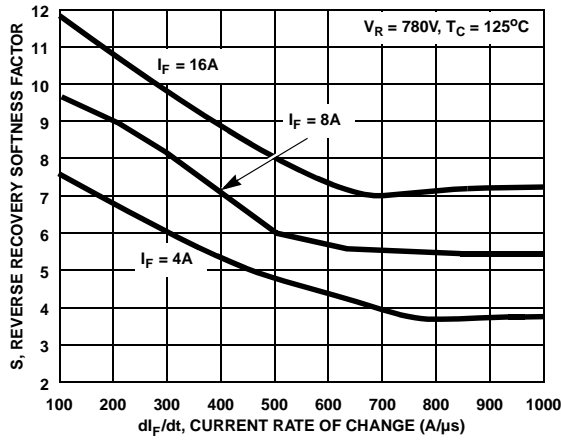

Figure 7. Reverse Recovery Softness Factor vs di_F/dt

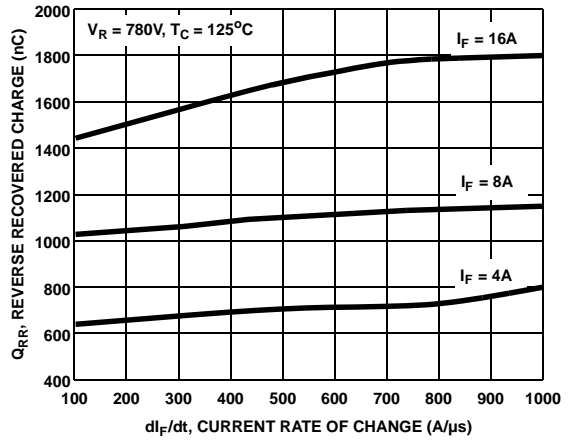

Figure 8. Reverse Recovered Charge vs di_F/dt

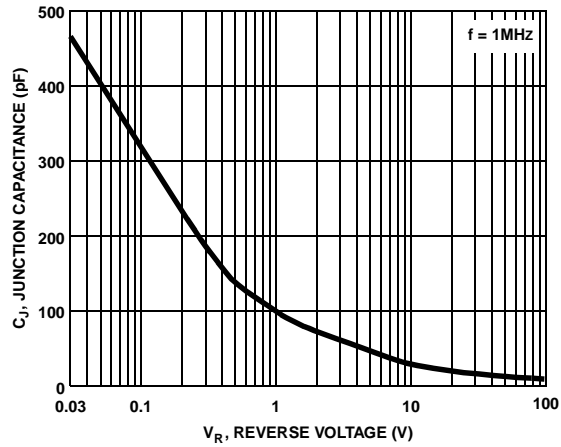

Figure 9. Junction Capacitance vs Reverse Voltage

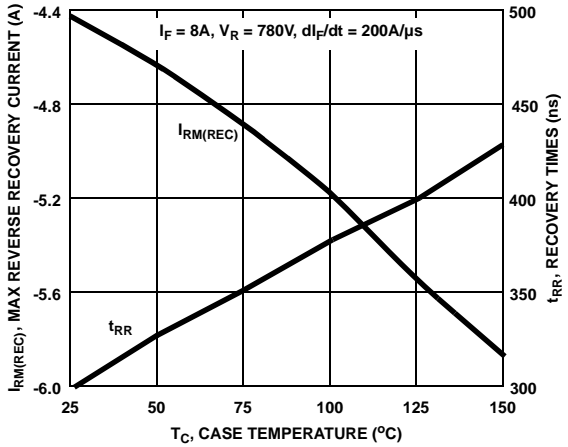

Figure 10. Reverse Recovery Current and Times vs Case Temperature

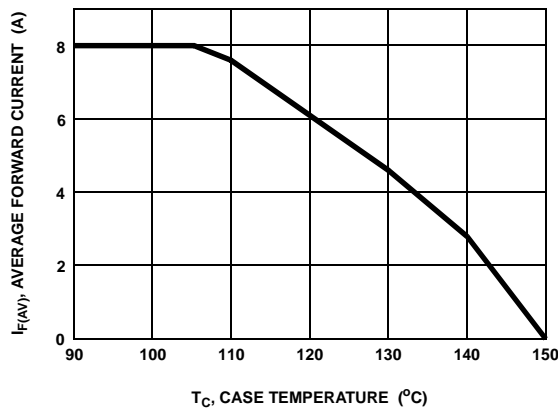

Figure 11. DC Current Derating Curve

Typical Performance Curves (per leg) (Continued)

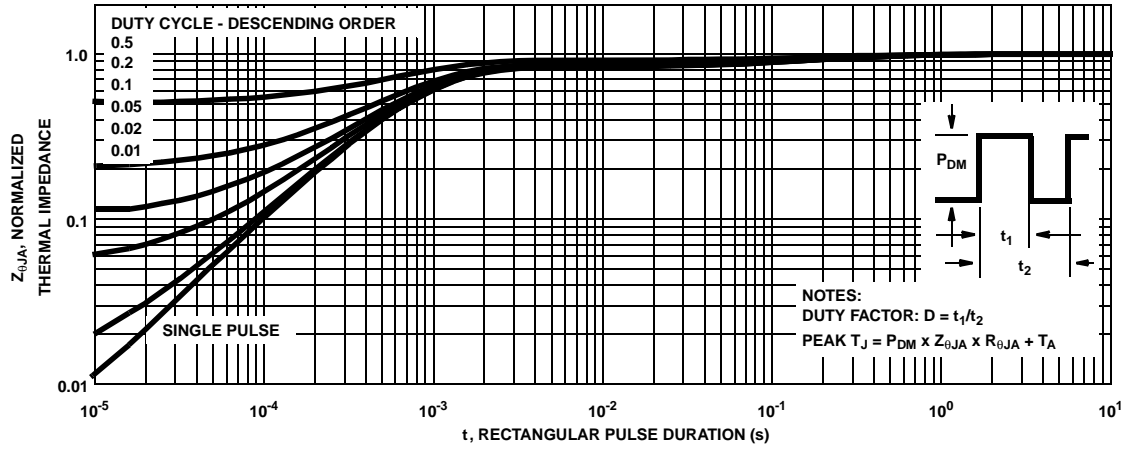

Figure 12. Normalized Maximum Transient Thermal Impedance

Test Circuit and Waveforms

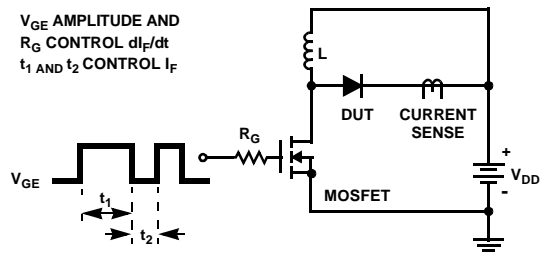

Figure 13. I_{tr} Test Circuit

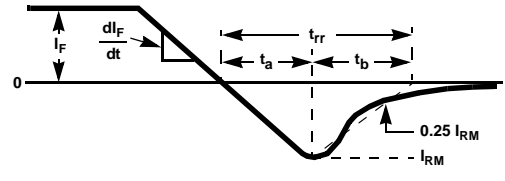

Figure 14. t_{rr} Waveforms and Definitions

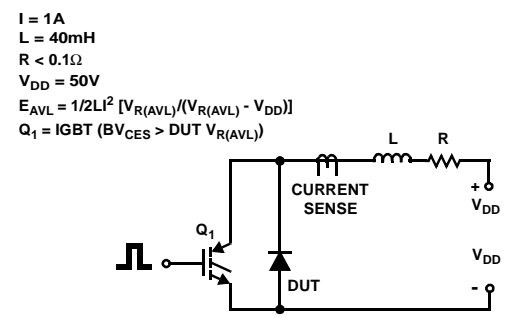

Figure 15. Avalanche Energy Test Circuit

$I = 1A$
 $L = 40mH$
 $R < 0.1\Omega$
 $V_{DD} = 50V$
 $E_{AVL} = 1/2LI^2 [V_{R(AVL)}/(V_{R(AVL)} - V_{DD})]$
 $Q_1 = IGBT (BV_{CES} > DUT V_{R(AVL)})$

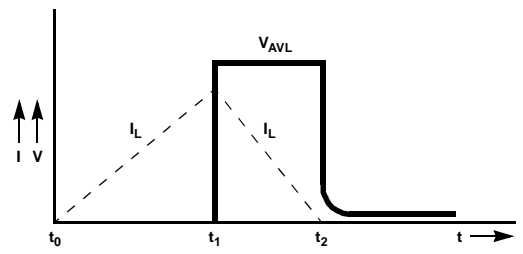

Figure 16. Avalanche Current and Voltage Waveforms

TRADEMARKS

The following are registered and unregistered trademarks Fairchild Semiconductor owns or is authorized to use and is not intended to be an exhaustive list of all such trademarks.

ACE _x [™]	FAST [®]	MICROWIRE [™]	SILENT SWITCHER [®]	UHC [™]
Bottomless [™]	FAST _r [™]	OPTOLOGIC [®]	SMART START [™]	UltraFET [®]
CoolFET [™]	FRFET [™]	OPTOPLANAR [™]	SPM [™]	VCX [™]
CROSSVOLT [™]	GlobalOptoisolator [™]	PACMAN [™]	STAR*POWER [™]	
DenseTrench [™]	GTO [™]	POP [™]	Stealth [™]	
DOME [™]	HiSeC [™]	Power247 [™]	SuperSOT [™] -3	
EcoSPARK [™]	I ² C [™]	PowerTrench [®]	SuperSOT [™] -6	
E ² CMOS [™]	ISOPLANAR [™]	QFET [™]	SuperSOT [™] -8	
EnSigna [™]	LittleFET [™]	QS [™]	SyncFET [™]	
FACT [™]	MicroFET [™]	QT Optoelectronics [™]	TinyLogic [™]	
FACT Quiet Series [™]	MicroPak [™]	Quiet Series [™]	TruTranslation [™]	

STAR*POWER is used under license

DISCLAIMER

FAIRCHILD SEMICONDUCTOR RESERVES THE RIGHT TO MAKE CHANGES WITHOUT FURTHER NOTICE TO ANY PRODUCTS HEREIN TO IMPROVE RELIABILITY, FUNCTION OR DESIGN. FAIRCHILD DOES NOT ASSUME ANY LIABILITY ARISING OUT OF THE APPLICATION OR USE OF ANY PRODUCT OR CIRCUIT DESCRIBED HEREIN; NEITHER DOES IT CONVEY ANY LICENSE UNDER ITS PATENT RIGHTS, NOR THE RIGHTS OF OTHERS.

LIFE SUPPORT POLICY

FAIRCHILD'S PRODUCTS ARE NOT AUTHORIZED FOR USE AS CRITICAL COMPONENTS IN LIFE SUPPORT DEVICES OR SYSTEMS WITHOUT THE EXPRESS WRITTEN APPROVAL OF FAIRCHILD SEMICONDUCTOR CORPORATION.

As used herein:

1. Life support devices or systems are devices or systems which, (a) are intended for surgical implant into the body, or (b) support or sustain life, or (c) whose failure to perform when properly used in accordance with instructions for use provided in the labeling, can be reasonably expected to result in significant injury to the user.
2. A critical component is any component of a life support device or system whose failure to perform can be reasonably expected to cause the failure of the life support device or system, or to affect its safety or effectiveness.

PRODUCT STATUS DEFINITIONS

Definition of Terms

Datasheet Identification	Product Status	Definition
Advance Information	Formative or In Design	This datasheet contains the design specifications for product development. Specifications may change in any manner without notice.
Preliminary	First Production	This datasheet contains preliminary data, and supplementary data will be published at a later date. Fairchild Semiconductor reserves the right to make changes at any time without notice in order to improve design.
No Identification Needed	Full Production	This datasheet contains final specifications. Fairchild Semiconductor reserves the right to make changes at any time without notice in order to improve design.
Obsolete	Not In Production	This datasheet contains specifications on a product that has been discontinued by Fairchild semiconductor. The datasheet is printed for reference information only.



LittleDiode supplies new, hard to find or obsolete electronic components and semiconductors all over the world.

With over two million different components listed you are sure to find the part you need.

Feel free to visit us today at our online store:

LittleDiode.com

Looking forward to providing you with the best possible service.