

# SHINDENGEN

## Darlington Transistor

**2SD1025**  
(T8L20)

**8A NPN**

### OUTLINE DIMENSIONS

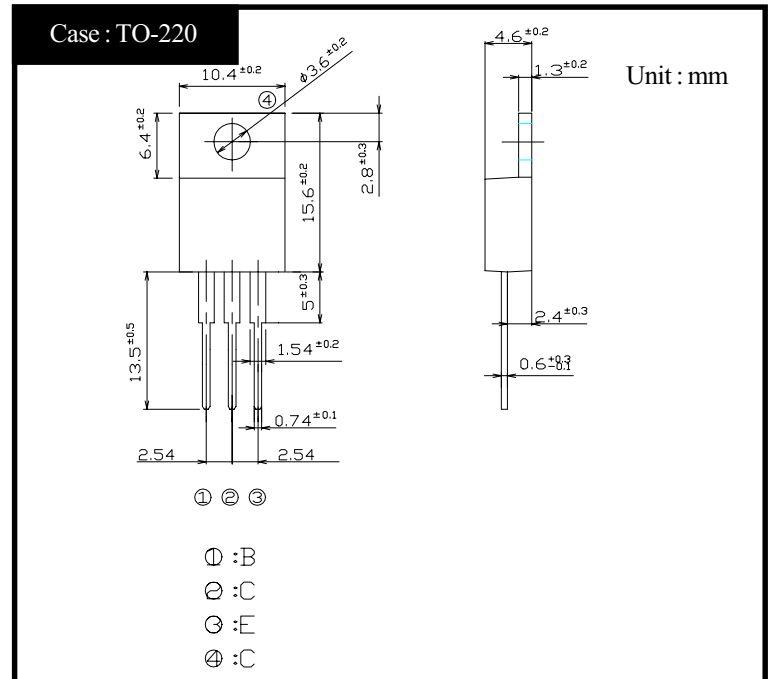

### RATINGS

#### ● Absolute Maximum Ratings

Item	Symbol	Conditions	Ratings	Unit
Storage Temperature	$T_{stg}$		-55~+150	°C
Junction Temperature	$T_j$		+150	°C
Collector to Base Voltage	$V_{CBO}$		200	V
Collector to Emitter Voltage	$V_{CEO}$		200	V
Emitter to Base Voltage	$V_{EBO}$		7	V
Collector Current DC	$I_C$		8	A
Collector Current Peak	$I_{CP}$		12	A
Base Current DC	$I_B$		0.5	A
Base Current Peak	$I_{BP}$		1	A
Total Transistor Dissipation	$P_T$	$T_c = 25^\circ\text{C}$	50	W
Mounting Torque	TOR	(Recommended torque : 0.3N·m)	0.5	N·m

#### ● Electrical Characteristics ( $T_c=25^\circ\text{C}$ )

Item	Symbol	Conditions	Ratings	Unit
Collector Cutoff Current	$I_{CBO}$	$V_{CB} = 200\text{V}$	Max 0.1	mA
	$I_{CEO}$	$V_{CE} = 200\text{V}$	Max 0.1	
Emitter Cutoff Current	$I_{EBO}$	$V_{EB} = 7\text{V}$	Max 5	mA
DC Current Gain	$h_{FE}$	$V_{CE} = 3\text{V}, I_C = 5\text{A}$	Min 1,500	
			Max 30,000	
Collector to Emitter Saturation Voltage	$V_{CE}(\text{sat})$	$I_C = 5\text{A}$	Max 1.5	V
Base to Emitter Saturation Voltage	$V_{BE}(\text{sat})$	$I_B = 10\text{mA}$	Max 2.0	V
Thermal Resistance	$\theta_{jc}$	Junction to case	Max 2.5	°C/W
Transition Frequency	$f_T$	$V_{CE} = 10\text{V}, I_C = 0.8\text{A}$	TYP 20	MHz
Turn on Time	$t_{on}$		Max 2	$\mu\text{s}$
Storage Time	$t_s$	$I_C = 5\text{A}$ $I_{B1} = I_{B2} = 10\text{mA}$ $R_L = 5\Omega$	Max 8	
Fall Time	$t_f$	$V_{BB2} = 4\text{V}$	Max 5	

# 2SD1025

$h_{FE} - I_C$

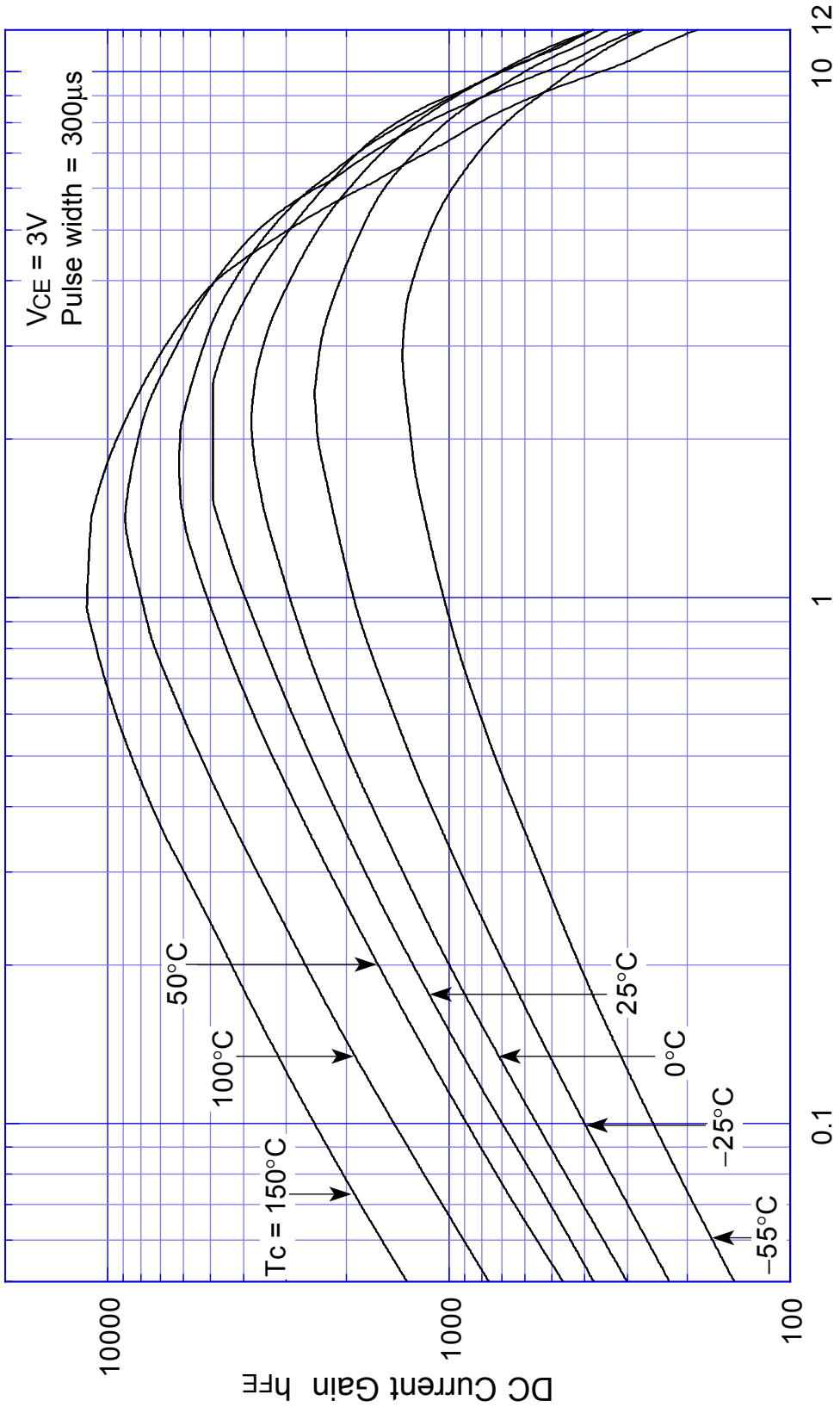

Collector Current  $I_C$  [A]

# 2SD1025 Saturation Voltage

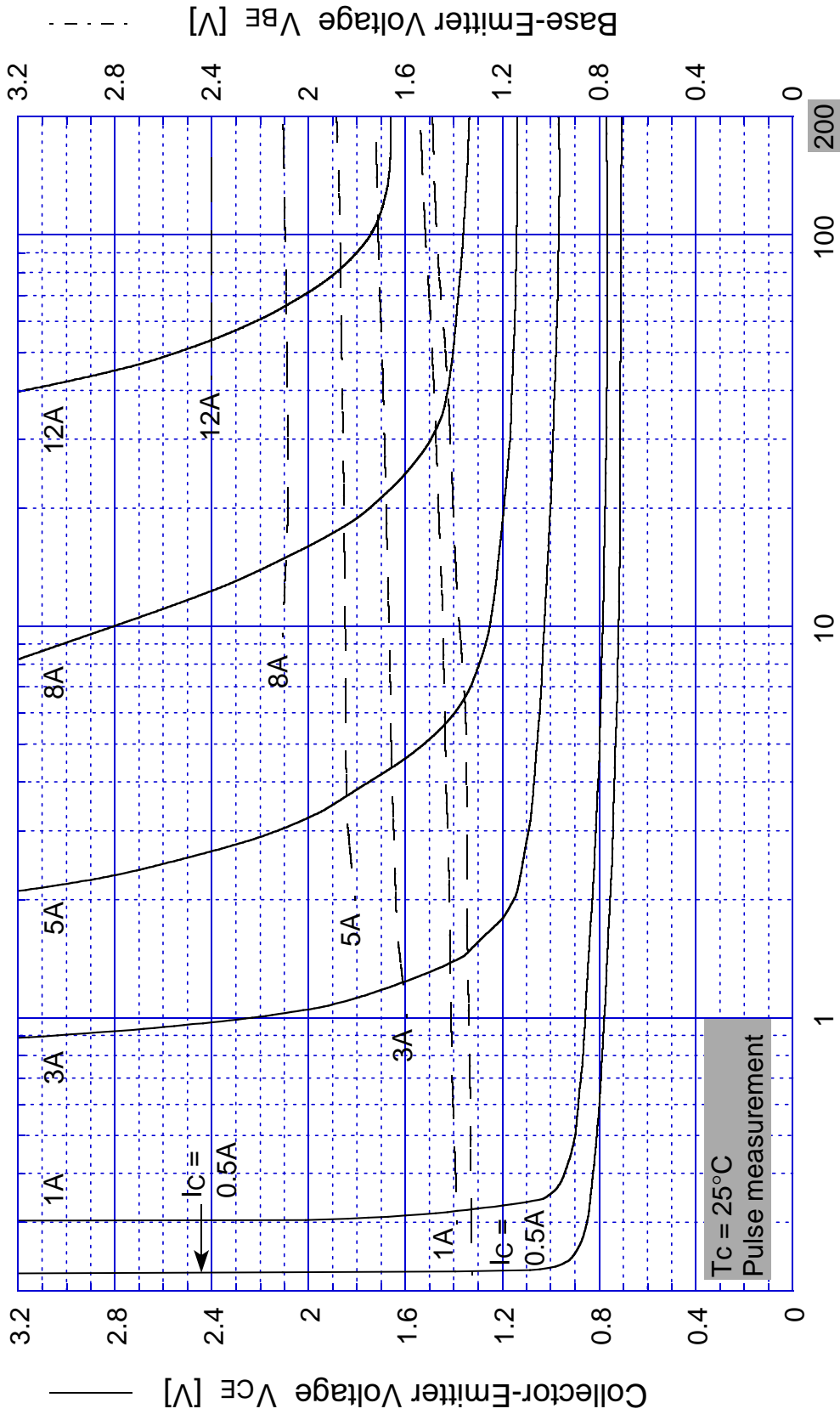

Base Current  $I_B$  [mA]

# 2SD1025

## Switching Time - $I_C$

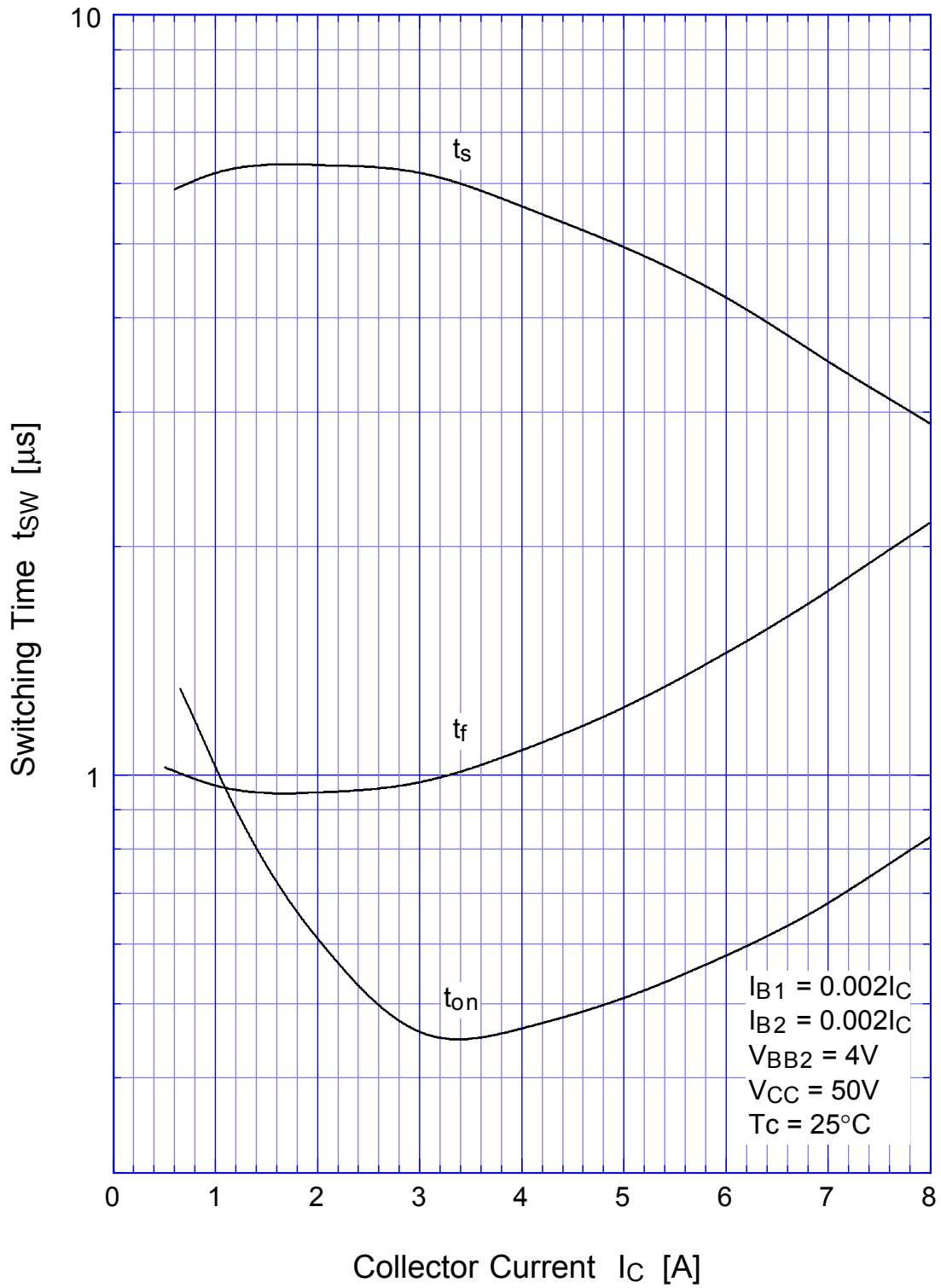

# 2SD1025

## Switching Time - Tc

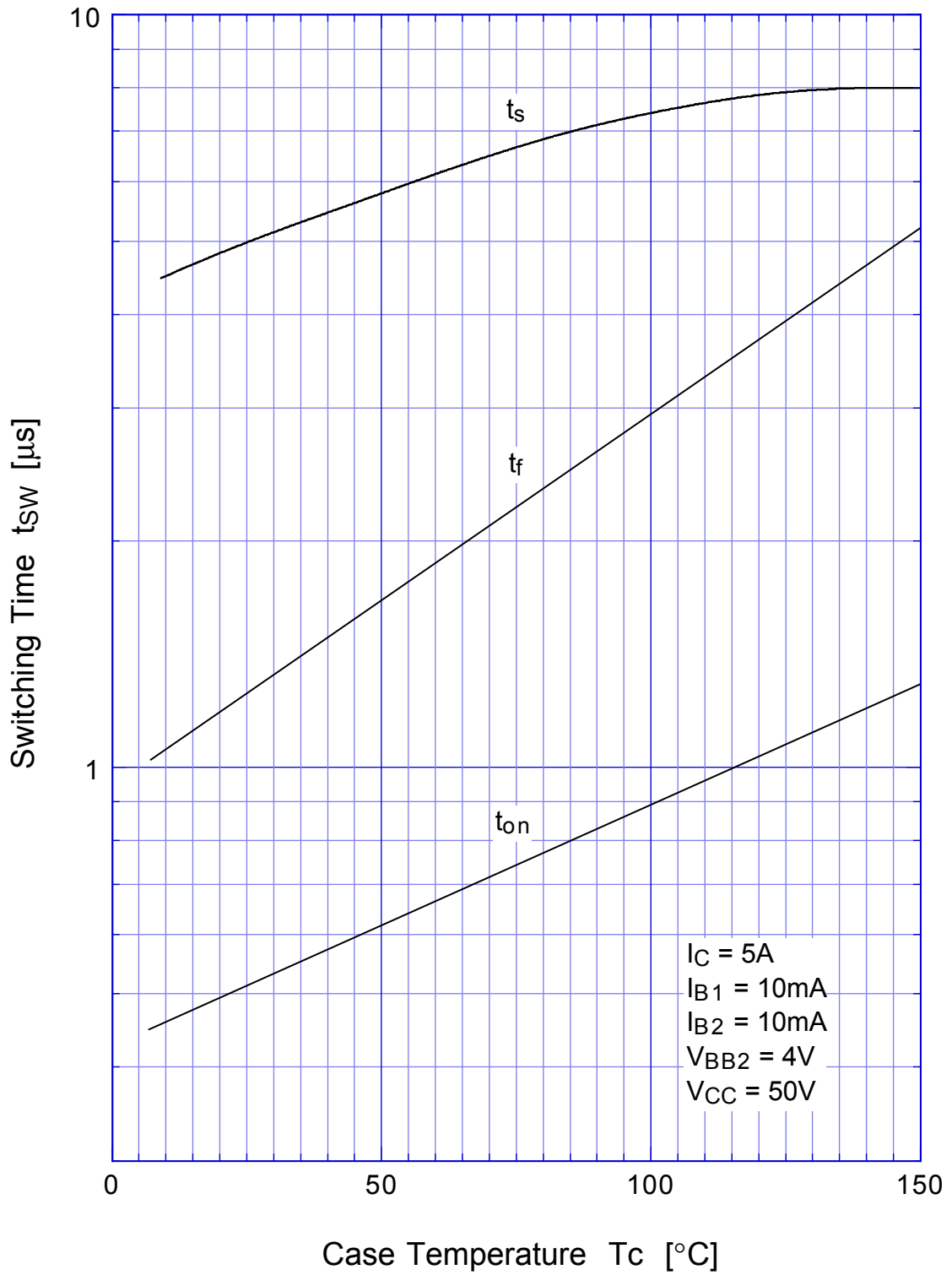

# 2SD1025 Transient Thermal Impedance

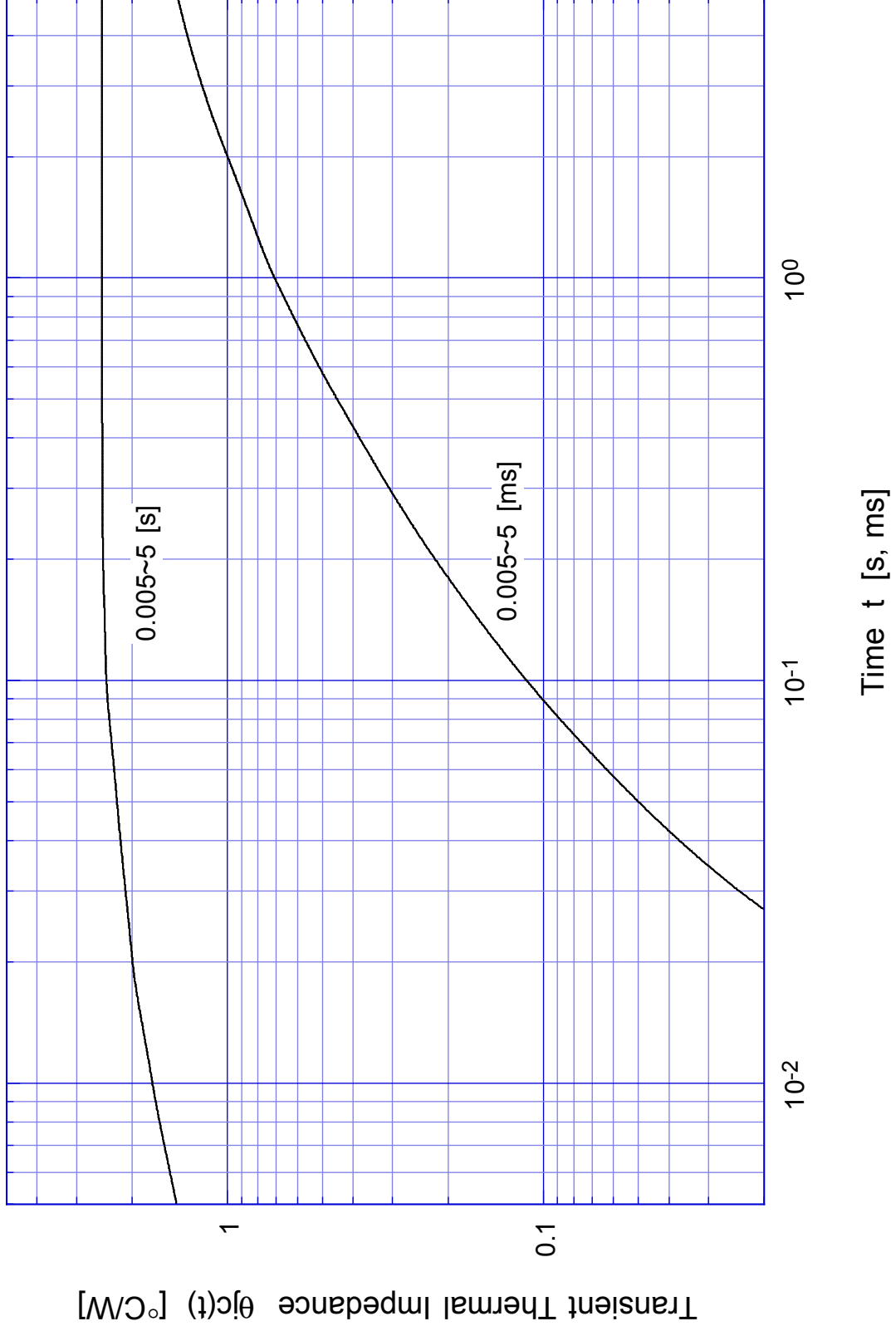

# 2SD1025

## Forward Bias SOA

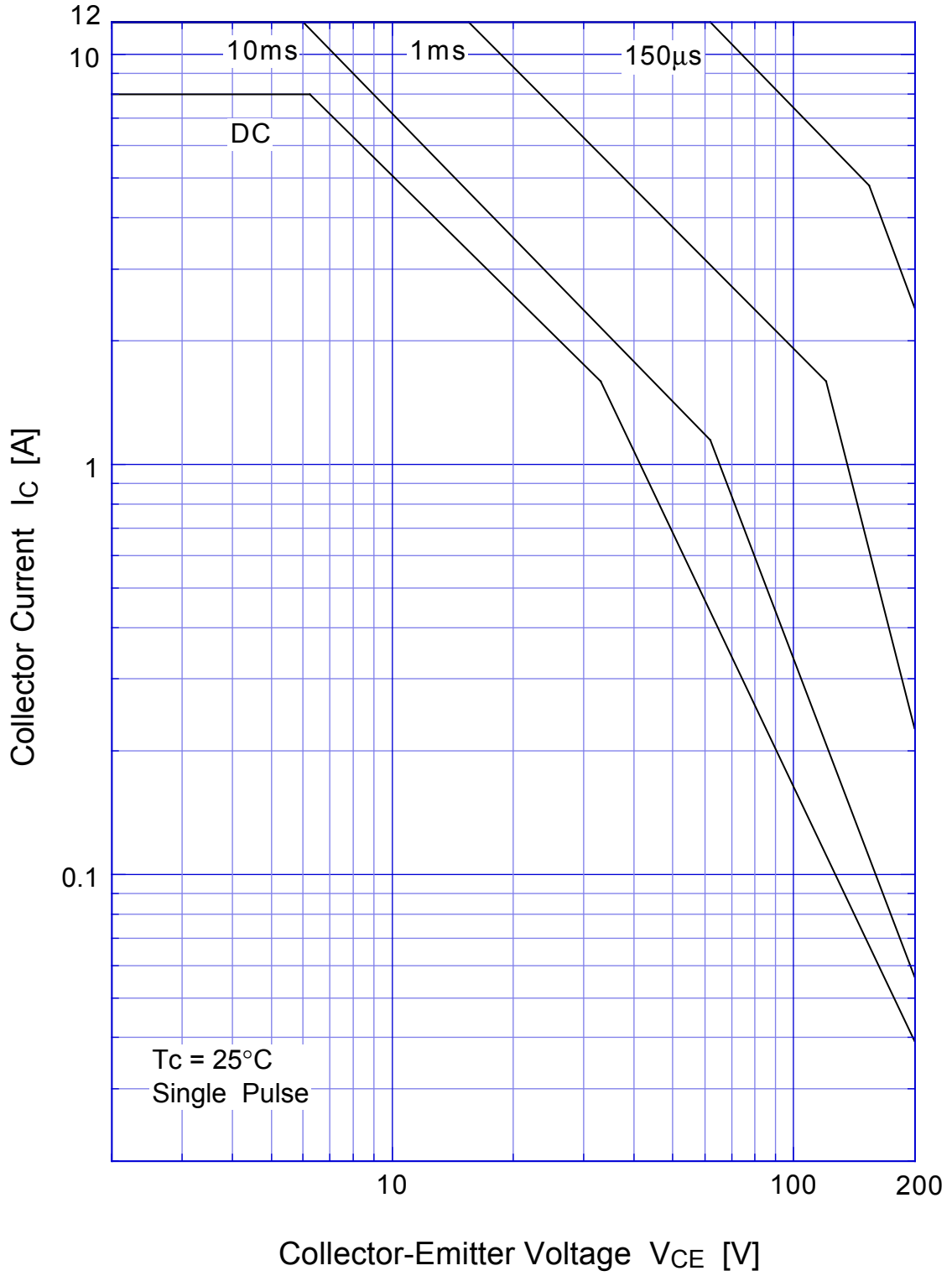

## 2SD1025 Collector Current Derating

