



N-Channel JFETs

PRODUCT SUMMARY				
Part Number	V _{GS(off)} (V)	r _{DS(on)} Max (Ω)	I _{D(off)} Typ (pA)	t _{ON} Typ (ns)
J105	-4.5 to -10	3	10	14
J106	-2 to -6	6	10	14
J107	-0.5 to -4.5	8	10	14

FEATURES

- Low On-Resistance: J105 < 3 Ω
- Fast Switching—t_{ON}: 14 ns
- Low Leakage: 10 pA
- Low Capacitance: 20 pF
- Low Insertion Loss

BENEFITS

- Low Error Voltage
- High-Speed Analog Circuit Performance
- Negligible “Off-Error,” Excellent Accuracy
- Good Frequency Response
- Eliminates Additional Buffering

APPLICATIONS

- Analog Switches
- Choppers
- Sample-and-Hold
- Normally “On” Switches
- Current Limiters

DESCRIPTION

The J105/106/107 are high-performance JFET analog switches designed to offer low on-resistance and fast switching. r_{DS(on)} < 3 Ω is guaranteed for the J105 making this device the lowest of any commercially available JFET.

The low cost TO-226AA (TO-92) plastic package is available in a wide range of tape-and-reel options (see Packaging Information). For similar products in TO-206AC (TO-52) packaging, see the U290/291 data sheet.

TO-226AA
(TO-92)

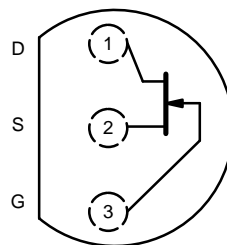

Top View

ABSOLUTE MAXIMUM RATINGS

Gate-Drain, Gate-Source Voltage -25 V
 Gate Current 50 mA
 Storage Temperature -55 to 150°C
 Operating Junction Temperature -55 to 150°C

Power Dissipation^a 350 mW

Notes
 a. Derate 2.8 mW/°C above 25°C



SPECIFICATIONS (T _A = 25 °C UNLESS OTHERWISE NOTED)										
Parameter	Symbol	Test Conditions	Typ ^a	Limits						Unit
				J105		J106		J107		
				Min	Max	Min	Max	Min	Max	
Static										
Gate-Source Breakdown Voltage	V _{(BR)GSS}	I _G = -1 μA, V _{DS} = 0 V	-35	-25		-25		-25		V
Gate-Source Cutoff Voltage	V _{GS(off)}	V _{DS} = 5 V, I _D = 1 μA		-4.5	-10	-2	-6	-0.5	-4.5	
Saturation Drain Current ^b	I _{DSS}	V _{DS} = 15 V, V _{GS} = 0 V		500		200		100		mA
Gate Reverse Current	I _{GSS}	V _{GS} = -15 V, V _{DS} = 0 V T _A = 125 °C	-0.02		-3		-3		-3	nA
			-10							
Gate Operating Current ^b	I _G	V _{DG} = 10 V, I _D = 25 mA	-0.01							nA
Drain Cutoff Current	I _{D(off)}	V _{DS} = 5 V, V _{GS} = -10 V T _A = 125 °C	0.01		3		3		3	
			5							
Drain-Source On-Resistance	r _{DS(on)}	V _{GS} = 0 V, I _D = 1 mA			3		6		8	Ω
Gate-Source Forward Voltage	V _{GS(F)}	I _G = 1 mA, V _{DS} = 0 V	0.7							V
Dynamic										
Common-Source Forward Transconductance ^b	g _{fs}	V _{DS} = 10 V, I _D = 25 mA f = 1 kHz	55							mS
			5							
Common-Source Output Conductance ^b	g _{os}									
Drain-Source On-Resistance	r _{ds(on)}	V _{GS} = 0 V, I _D = 0 mA f = 1 kHz			3		6		8	Ω
Common-Source Input Capacitance	C _{iss}	V _{DS} = 0 V, V _{GS} = 0 V f = 1 MHz	120		160		160		160	pF
Common-Source Reverse Transfer Capacitance	C _{rss}	V _{DS} = 0 V, V _{GS} = -10 V f = 1 MHz	20		35		35		35	
Equivalent Input Noise Voltage	e _n	V _{DG} = 10 V, I _D = 25 mA f = 1 kHz	3							nV/ √Hz
Switching										
Turn-On Time	t _{d(on)}	V _{DD} = 1.5 V, V _{GS(H)} = 0 V See Switching Diagram	6							ns
	t _r		8							
Turn-Off Time	t _{d(off)}		5							
	t _f		9							

Notes
a. Typical values are for DESIGN AID ONLY, not guaranteed nor subject to production testing.
b. Pulse test: PW ≤ 300 μs duty cycle ≤ 3%.



TYPICAL CHARACTERISTICS ($T_A = 25^\circ\text{C}$ UNLESS OTHERWISE NOTED)

On-Resistance and Drain Current vs. Gate-Source Cutoff Voltage

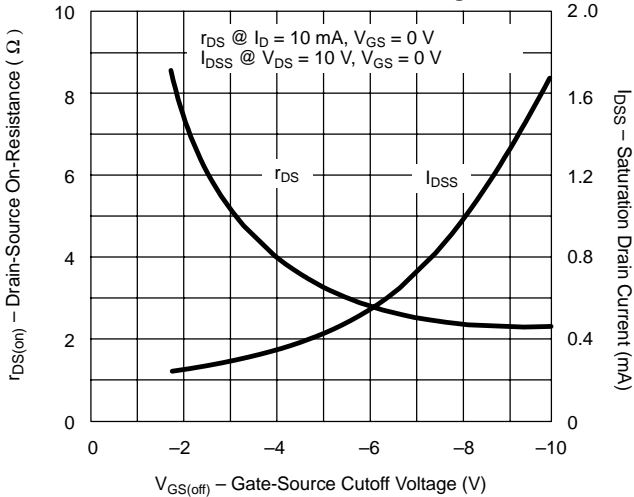

On-Resistance vs. Drain Current

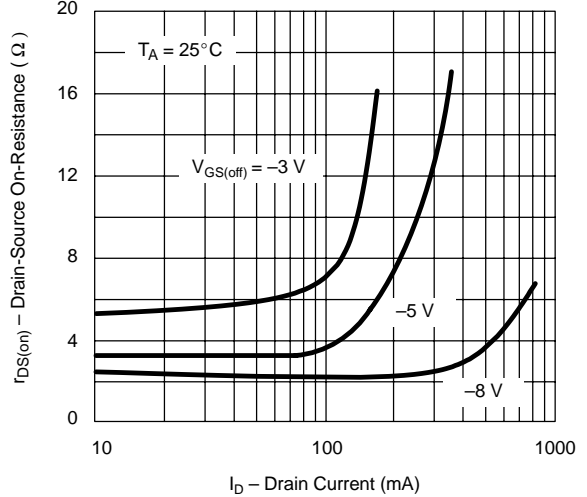

On-Resistance vs. Temperature

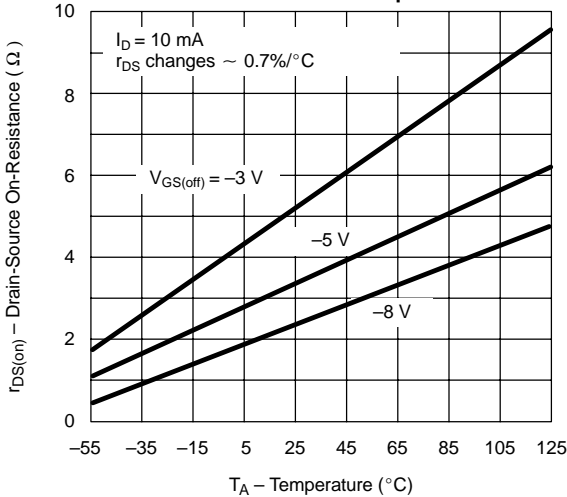

Output Characteristics

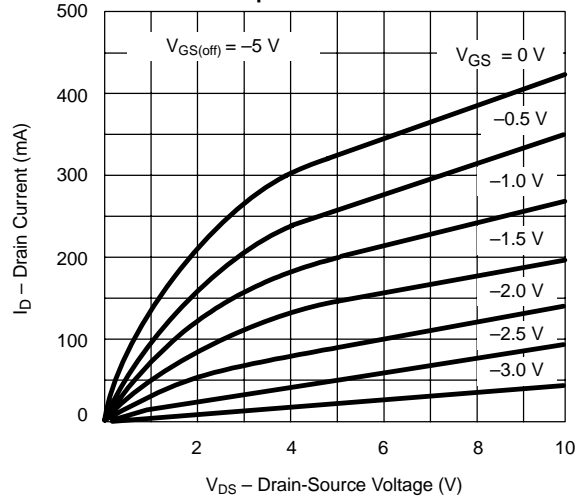

Turn-On Switching

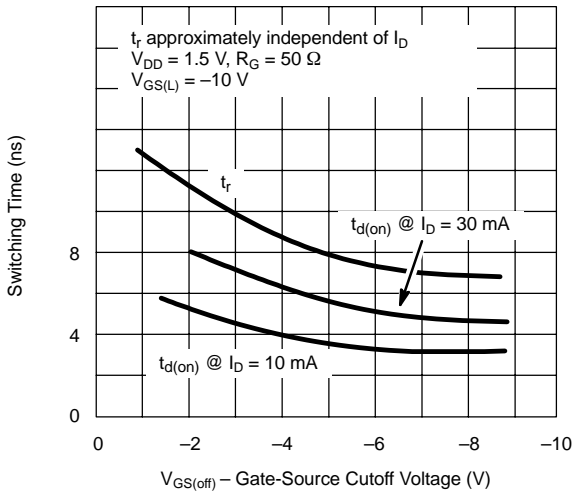

Turn-Off Switching

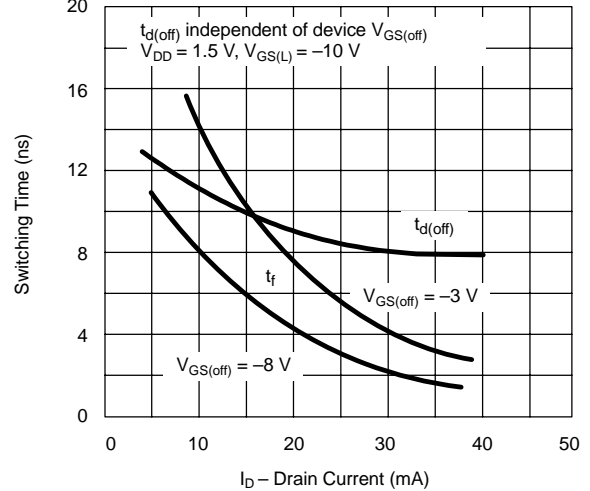

TYPICAL CHARACTERISTICS ($T_A = 25^\circ\text{C}$ UNLESS OTHERWISE NOTED)

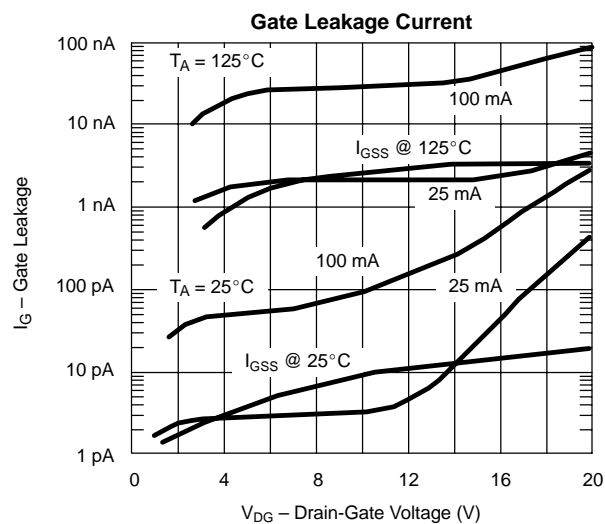
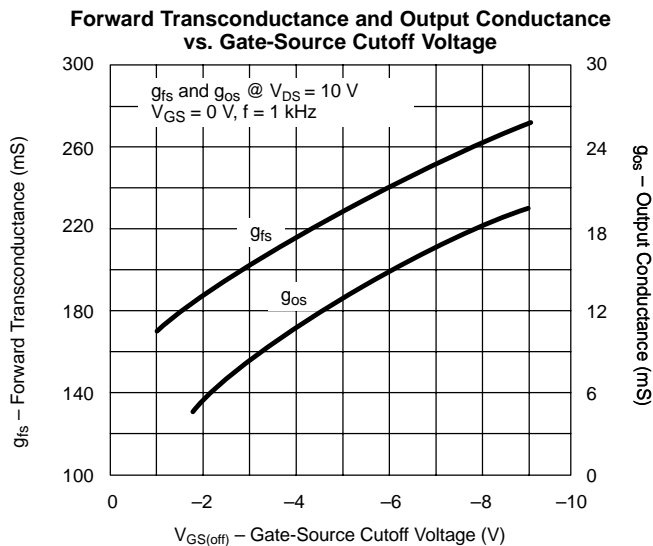
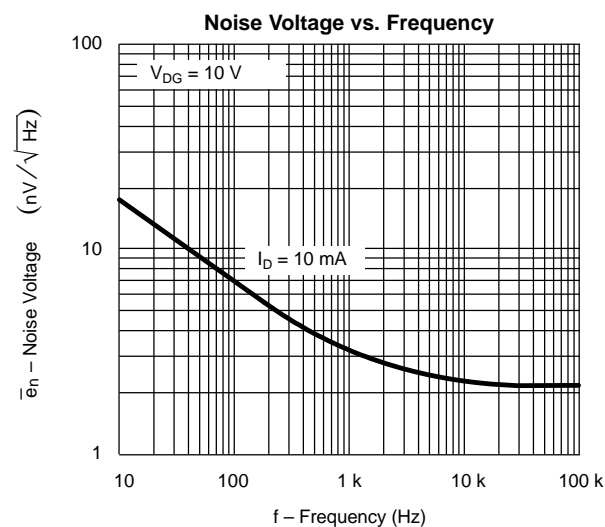
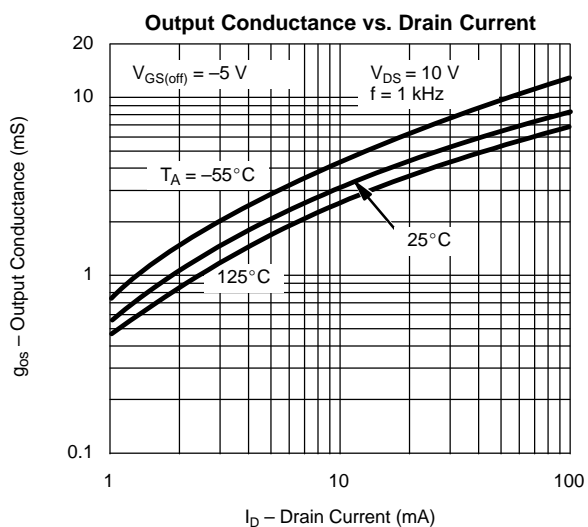
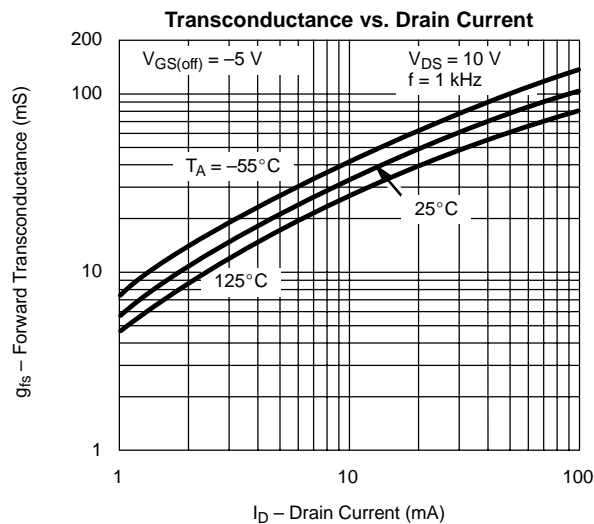
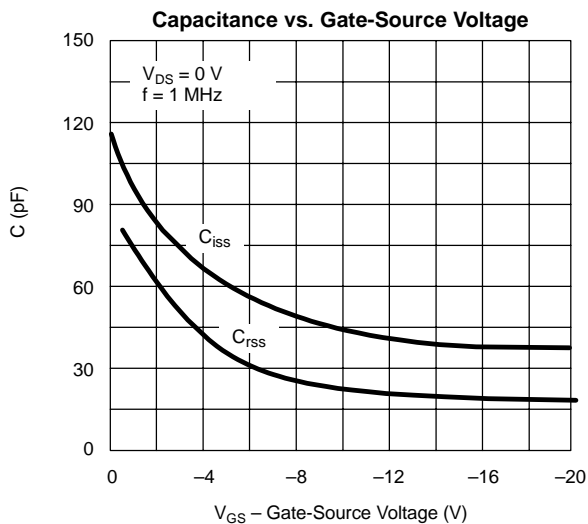

SWITCHING TIME TEST CIRCUIT			
	J105	J106	J107
$V_{GS(L)}$	-12V	-7V	-5V
R_L^*	50 Ω	50 Ω	50 Ω
$I_{D(on)}$	28 mA	27 mA	26 mA

*Non-inductive

Input Pulse

Rise Time < 1 ns
 Fall Time < 1 ns
 Pulse Width 100 ns
 PRF 1 MHz

Sampling Scope

Rise Time 0.4 ns
 Input Resistance 10 M Ω
 Input Capacitance 1.5 pF

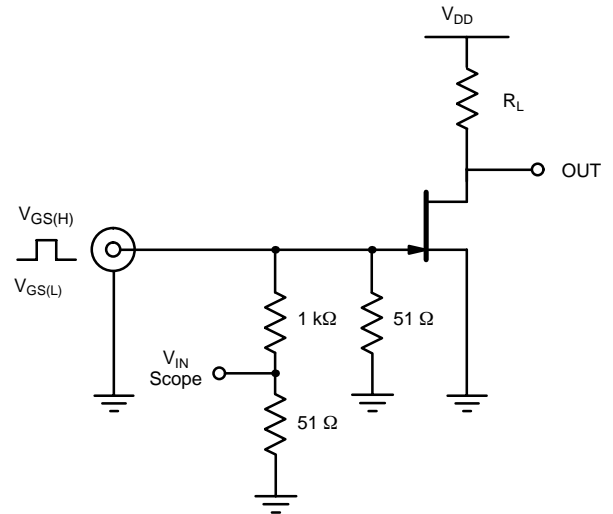



LittleDiode supplies new, hard to find or obsolete electronic components and semiconductors all over the world.

With over two million different components listed you are sure to find the part you need.

Feel free to visit us today at our online store:

LittleDiode.com

Looking forward to providing you with the best possible service.