

## N-CHANNEL SILICON POWER MOS-FET

## FAP-II SERIES

### Features

- High speed switching
- Low on-resistance
- No secondary breakdown
- Low driving power
- High voltage
- $V_{GS} = \pm 30V$  Guarantee
- Avalanche-proof

### Applications

- Switching regulators
- UPS
- DC-DC converters
- General purpose power amplifier

### Outline Drawings

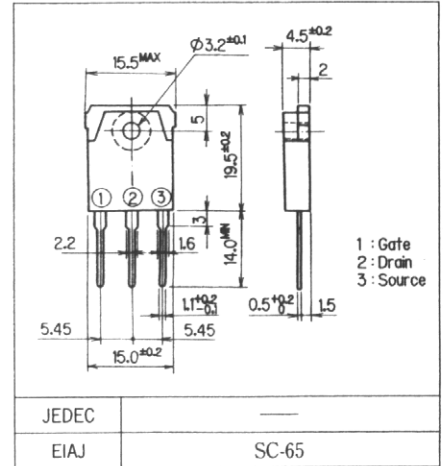

### Max. Ratings and Characteristics

#### Absolute Maximum Ratings ( $T_c = 25^\circ C$ )

Items	Symbols	Ratings	Units
Drain-source voltage	$V_{DSS}$	900	V
Continuous drain current	$I_D$	6	A
Pulsed drain current	$I_{D(puls)}$	18	A
Continuous reverse drain current	$I_{DR}$	6	A
Gate-source peak voltage	$V_{GSS}$	$\pm 30$	V
Max. power dissipation	$P_D$	125	W
Operating and storage temperature range	$T_{ch}$	150	$^\circ C$
	$T_{stg}$	$-55 \sim +150$	$^\circ C$

### Equivalent Circuit Schematic

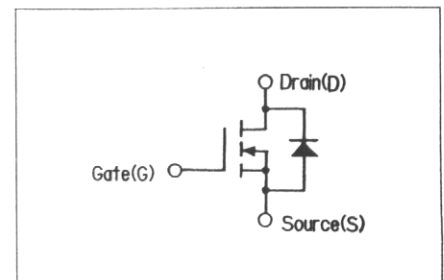

#### Electrical Characteristics ( $T_c = 25^\circ C$ )

Items	Symbols	Test Conditions	Min.	Typ.	Max.	Units
Drain-source breakdown voltage	$V_{(BR)DSS}$	$I_D = 1mA$ $V_{GS} = 0V$	900			V
Gate threshold voltage	$V_{GS(th)}$	$I_D = 1mA$ $V_{DS} = V_{GS}$	2.5	3.5	5.0	V
		$V_{DS} = 900V$ $V_{GS} = 0V$		10	500	$\mu A$
Zero gate voltage drain current	$I_{DSS}$	$T_{ch} = 25^\circ C$		0.2	1.0	mA
		$T_{ch} = 125^\circ C$				
Gate-source leakage current	$I_{GSS}$	$V_{GS} = \pm 30V$ $V_{DS} = 0V$		10	100	nA
Drain-source on-state resistance	$R_{DS(on)}$	$I_D = 3A$ $V_{GS} = 10V$		2.1	2.8	$\Omega$
Forward transconductance	$g_{fs}$	$I_D = 3A$ $V_{DS} = 25V$	2.0	4.5		S
Input capacitance	$C_{iss}$	$V_{DS} = 25V$		1200	1800	pF
Output capacitance	$C_{oss}$	$V_{GS} = 0V$		140	210	
Reverse transfer capacitance	$C_{rss}$	$f = 1MHz$		50	75	
Turn-on time $t_{on}$ ( $t_{on} + t_{d(on)} + t_r$ )	$t_{d(on)}$	$V_{CC} = 600V$ $I_D = 6A$ $V_{GS} = 10V$ $R_G = 25\Omega$		35	55	ns
	$t_r$			110	170	
Turn-off time $t_{off}$ ( $t_{d(off)} + t_f$ )	$t_{d(off)}$			150	230	
	$t_f$			100	150	
Diode forward on-voltage	$V_{SD}$	$I_F = 2 \times I_{DR}$ $V_{GS} = 0V$ $T_{ch} = 25^\circ C$		1.0	1.5	V
Reverse recovery time	$t_{rr}$	$I_F = I_{DR}$ $di/dt = 100A/\mu S$ $T_{ch} = 25^\circ C$		800		ns

#### Thermal Characteristics

Items	Symbols	Test Conditions	Min.	Typ.	Max.	Units
Thermal Resistance	$R_{th(ch-a)}$	channel to air			35.0	$^\circ C/W$
	$R_{th(ch-c)}$	channel to case			1.0	$^\circ C/W$

■ Characteristics

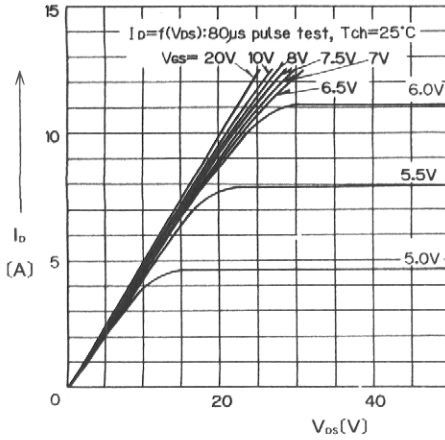

Typical Output Characteristics

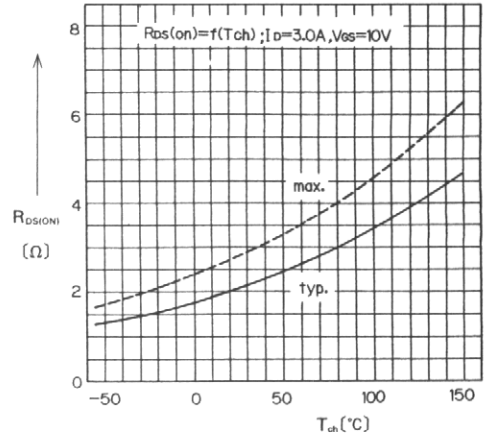

On State Resistance vs.  $T_{ch}$

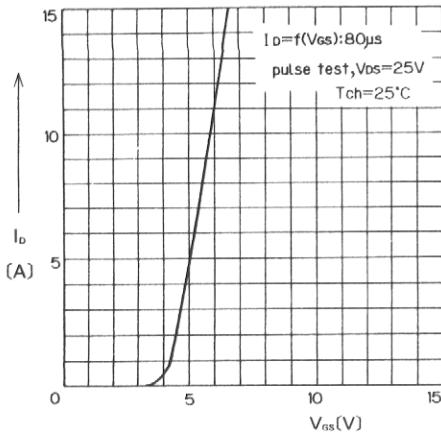

Typical Transfer Characteristics

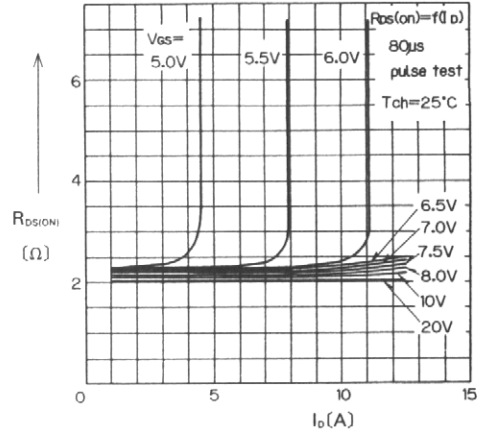

Typical Drain-Source on State Resistance vs.  $I_D$

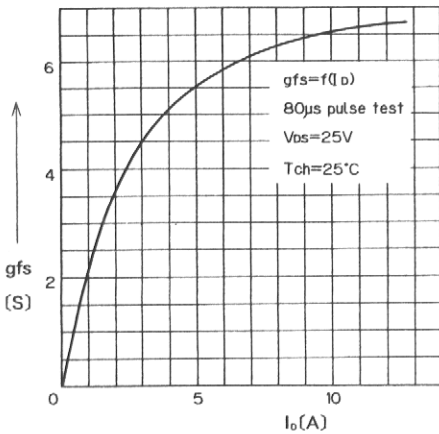

Typical Forward Transconductance vs.  $I_D$

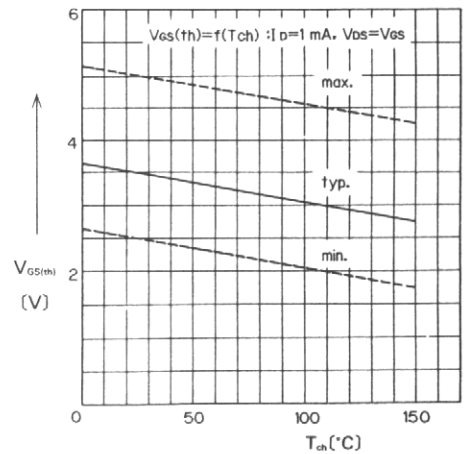

Gate Threshold Voltage vs.  $T_{ch}$

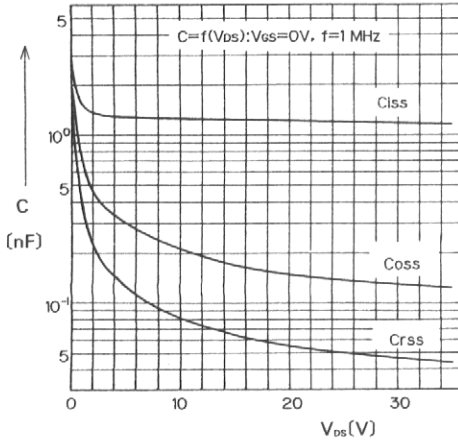

Typical Capacitance vs.  $V_{DS}$

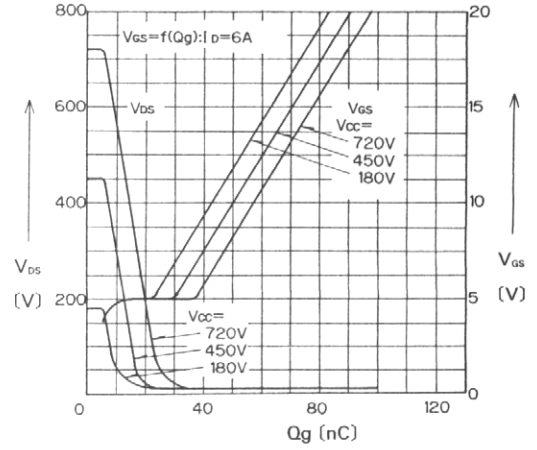

Typical Input Charge

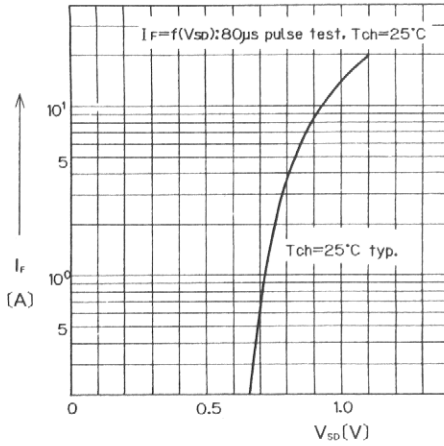

Forward Characteristics of Reverse Diode

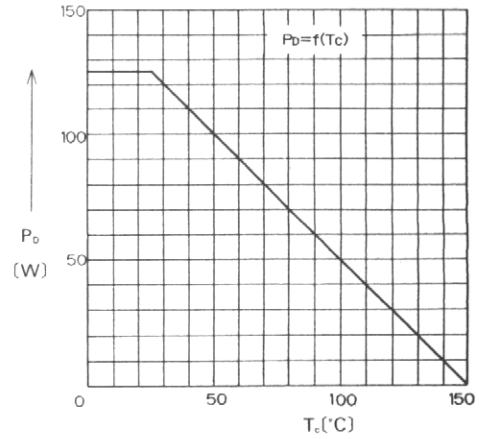

Allowable Power Dissipation vs.  $T_c$

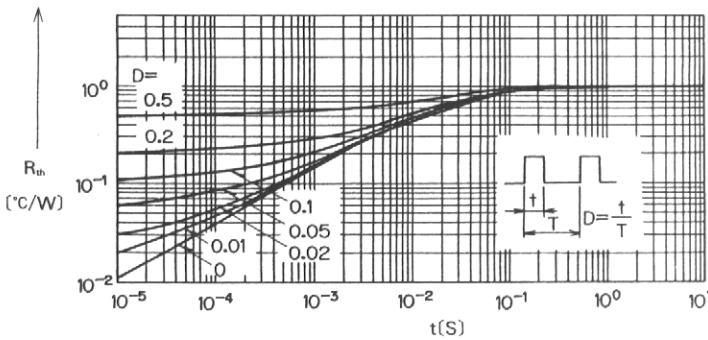

Transient Thermal Impedance

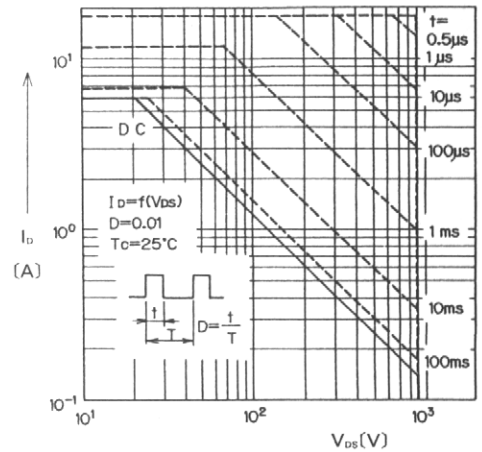

Safe Operating Area



LittleDiode supplies new, hard to find or obsolete electronic components and semiconductors all over the world.

With over two million different components listed you are sure to find the part you need.

Feel free to visit us today at our online store:

[LittleDiode.com](http://LittleDiode.com)

Looking forward to providing you with the best possible service.