

DESCRIPTION

The M51843P monolithic timing circuit is highly stable controller capable of producing accurate time delays, or oscillation. Additional terminals are provided for two voltage comparators, triggering or resetting, if desired, applicable for a wide range of usage as monostable or astable multivibrators. The circuit consists of noise filter pin, shutdown control circuit, and zener diode for supply voltage regulation, providing excellent anti-noise characteristics.

FEATURES

- Capable of forming a monostable multivibrator with a resistor and a capacitor
- Capable of forming an astable multivibrator with two resistors and a capacitor
- Supply voltage rejection ratio..... 0.01%V (typ.)
- Temperature coefficient..... 50ppm/°C (typ.)
- High output current..... 100mA (max.)
- Noise filter pin provided
- Discharge control, and shutdown control pins
- Built-in zener diode for supply voltage regulation
- Emitter and collector outputs

APPLICATION

Time delay generator (monostable multivibrator), pulse oscillator, pulsewidth modulation, pulse position modulation, sequential timer

RECOMMENDED OPERATING CONDITIONS

Supply voltage range..... 4.5~16V
 Rated supply voltage..... 5V, 12V, 15V

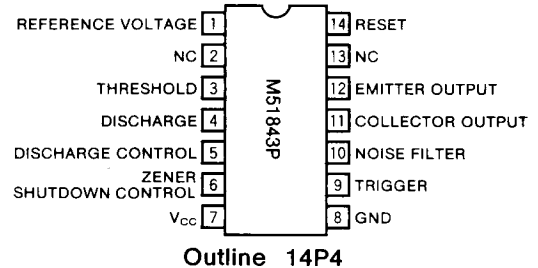
PIN CONFIGURATION (TOP VIEW)

NC : NO CONNECTION

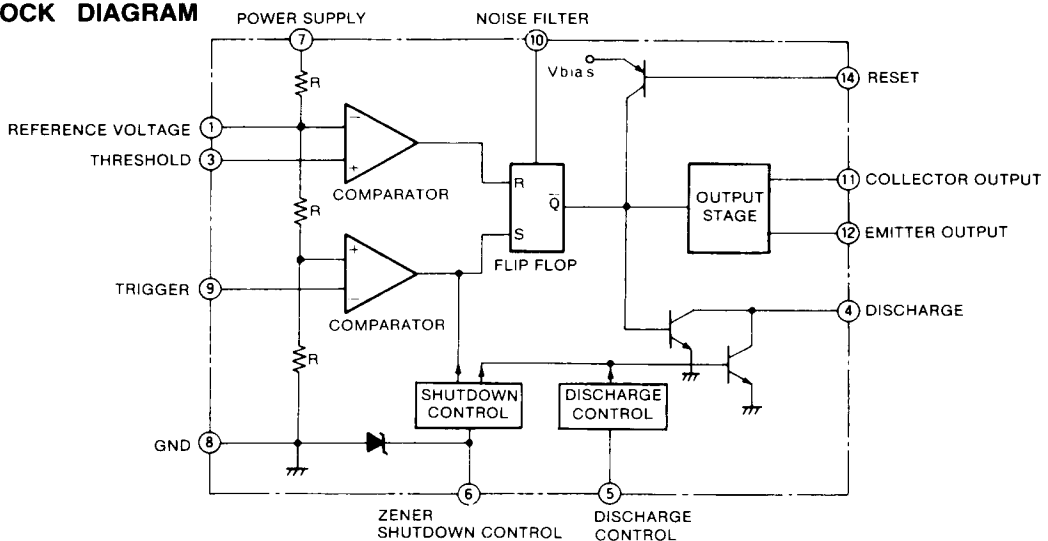
BLOCK DIAGRAM

ABSOLUTE MAXIMUM RATINGS ($T_a=25^\circ\text{C}$, unless otherwise noted)

Symbol	Parameter	Conditions	Ratings	Unit
V_{CC}	Supply voltage		18	V
I_Z	Zener Current		10	mA
I_{OC}	Collector output current	Saturation	200	mA
$BV^{(1)}$	Breakdown voltage (pin ⁽¹⁾)		27	V
P_d	Power dissipation		650	mW
K_θ	Thermal derating	$T_a \geq 25^\circ\text{C}$	6.5	mW/ $^\circ\text{C}$
T_{opr}	Operating temperature		-20 ~ +75	$^\circ\text{C}$
T_{stg}	Storage temperature		-40 ~ +125	$^\circ\text{C}$

ELECTRICAL CHARACTERISTICS ($T_a=25^\circ\text{C}$ $V_{CC}=5\sim 15\text{V}$)

Symbol	Parameter	Test Conditions		Limits			Unit
		$V_{CC}(\text{V})$		Min	Typ	Max	
V_{CC}	Supply voltage			4.5		16	V
I_{OC}	Circuit current	5	Excluding pin ⁽⁶⁾ $R_L = \infty$		4	10	mA
		15			13	22	
V_{REF}	Reference voltage	5		2.6	3.33	4.0	V
		15		9	10	11	
V_{TH}	Threshold voltage				$2/3V_{CC}$		V
I_{TH}	Threshold current				0.1	0.25	μA
V_T	Trigger voltage				$1/3V_{CC}$		V
I_T	Trigger current				0.5	1.0	μA
V_R	Reset voltage				0.7	1.0	V
I_R	Reset current				0.1		mA
V_Z	Zener voltage		$I_Z = 2\text{mA}$	6.5	7.5	8.5	V
V_{SC}	Voltage range of shutdown control at pin ⁽⁶⁾				2.4	4.0	V
V_{DCC}	Voltage range of discharge control				$0.7+V_{CC}$	$1.0+V_{CC}$	V
V_{OC}	Collector output voltage	5	$I_{OC}=30\text{mA}$		0.15	0.3	V
		15	$I_{OC}=10\text{mA}$		0.05	0.1	
		15	$I_{OC}=100\text{mA}$		0.3	1.0	
I_{OE}	Emitter output current	15		1	2		mA
f_{max}	Maximum operating frequency			10			kHz
—	Timing accuracy				0.5		%
—	Temperature coefficient				50		ppm/ $^\circ\text{C}$
—	Supply voltage rejection ratio				0.01		%/V
—	rise time				150		ns

TYPICAL CHARACTERISTICS (unless otherwise noted, $T_a=25^\circ\text{C}$)

**THERMAL DERATING
(MAXIMUM RATING)**

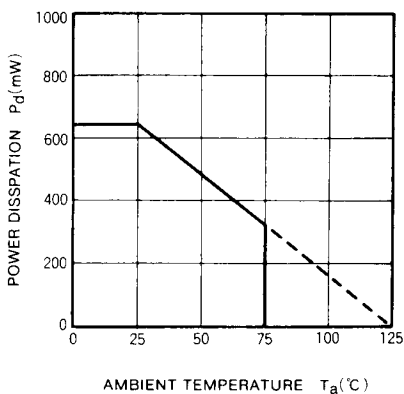

**CIRCUIT CURRENT
VS. SUPPLY VOLTAGE**

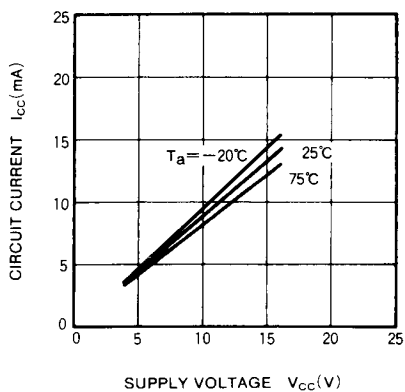

**COLLECTOR OUTPUT VOLTAGE
VS. OUTPUT CURRENT**

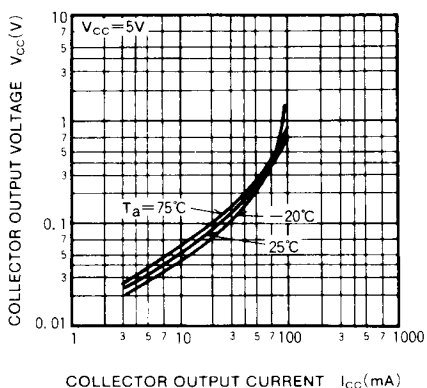

**COLLECTOR OUTPUT VOLTAGE
VS. OUTPUT CURRENT**

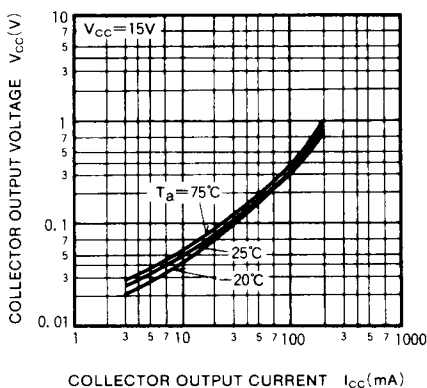

**EMITTER OUTPUT CURRENT
VS. SUPPLY VOLTAGE**

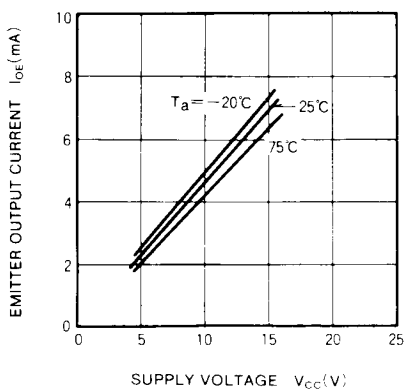

**MINIMUM PULSE WIDTH
VS. LOWEST VOLTAGE LEVEL
OF TRIGGER**

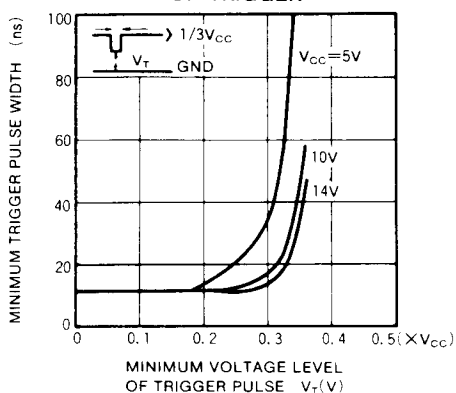

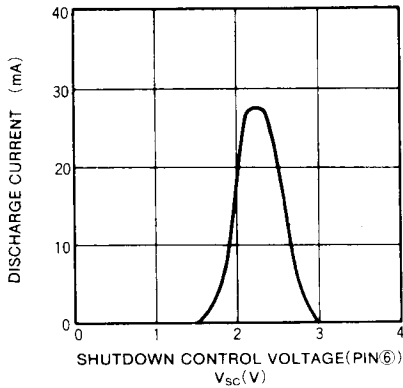
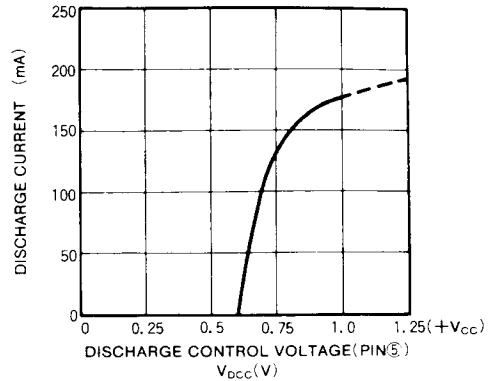
SHUTDOWN CONTROL CHARACTERISTICS**DISCHARGE CONTROL CHARACTERISTICS****PIN DESCRIPTION****1. Reference voltage pin (pin ①)**

The voltage at this pin is normally set at $2/3V_{CC}$. By applying reference voltage, delay time or oscillation frequency can be changed. The control signal for pulse-width modulation is applied at this pin. Connect a capacitor of $0.01\mu\text{F}$ between this pin and GND as the noise filter, if the pin is not used.

2. Threshold pin (pin ③)

The delay time is determined by CR time constants connected to this pin. The delay time of a monostable multivibrator t_d is expressed by the equation $t_d \approx 1.1R_A C_A$.

3. Discharge pin (pin ④)

The timed capacitor discharges at this pin. The discharge is enabled when a flip flop in the device is ON and the reset signal, discharge control signal or shutdown signal are applied. In a monostable multivibrator, the capacitor is connected to pin ③.

4. Discharge control pin (pin ⑤)

If a capacitor is connected between this pin and GND, the discharge pin (discharge transistor) is enabled by applying discharge control signal (approximately $V_{CC} + 0.7\text{V}$) to this pin. The timing capacitor can be automatically discharged when power supply drops. The capacitance should be $1/10$ - $1/30$ of that of the timing capacitor.

5. Zener/shutdown control pin (pin ⑥)

Supply voltage can be regulated (at approximately 8V) by connecting this pin to V_{CC} (pin ⑦). By controlling the voltage at this pin as the shutdown control voltage (approximately 2.4V), discharge of timing capacitor and OFF of the output stage can be controlled.

6. Trigger pin (pin ⑨)

When the voltage level at trigger pin is reduced to lower than $1/3V_{CC}$, timing operating is started.

7. Noise filter pin (pin ⑩)

Connect a capacitor between this pin and GND as the noise filter. Appropriate capacitance must be chosen according to the noise induced. (Normally less than $0.1\mu\text{F}$)

8. Collector output pin (pin ⑪)

The maximum load current of 200mA can be applied.

Logic output level is in the low state from the high state when the output stage is ON.

9. Emitter output pin (pin ⑫)

This pin drives externally connected transistors or thyristors. The load current is 2mA typ.

10. Reset pin (pin ⑬)

Timing operation can be interrupted by applying the reset signal to a reset pin. (The voltage at this pin must be less than 1V.)

If the reset signal is applied, the output is in the low state and the reset condition is maintained as long as the signal is applied. The output stays in the low state until the reset signal is replaced with the set signal (trigger signal at a trigger pin). Connect this pin to V_{CC} if not used.

APPLICATION EXAMPLES

(1) DELAY TIMER

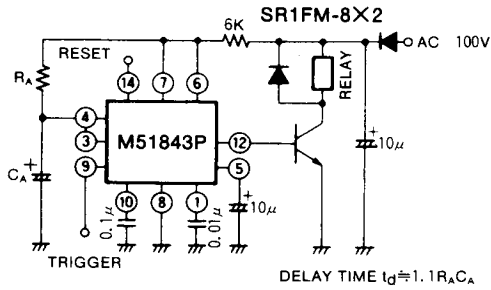

Unit :
Resistance : Ω
Capacitance : F

(2) ASTABLE OPERATION

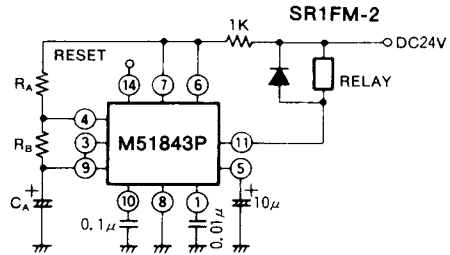

FREE RUNNING FREQUENCY
 $f \approx 1.44 / (R_A + 2R_B) C_A$
duty cycle
 $D = R_B / (R_A + 2R_B)$