

7-UNIT 500mA DARLINGTON TRANSISTOR ARRAY WITH CLAMP DIODE

DESCRIPTION

The M54525P, 7-channel sink driver, consists of 14 NPN transistors connected to form high current gain driver pairs.

FEATURES

- High output sustaining voltage to 50V
- High output sink current to 500mA
- Integral diodes for transient suppression
- 24V PMOS compatible input
- Wide operating temperature range ($T_a = -20 \sim +75^\circ\text{C}$)

APPLICATION

Relay and printer driver, LED or incandescent display digit driver, Interfacing for standard MOS/BIPOLAR logics

FUNCTION

The M54525P is comprised of seven NPN darlington driver pairs. Each input has a Zener diode and 10.5kΩ resistor in series to limit the input current. Between pin 9 and each output, there are integral diodes for inductive load transient suppression. All emitters and the substrate are connected together to pin 8. The outputs are capable of sinking 500mA and will withstand 50V in the OFF state.

PIN CONFIGURATION (TOP VIEW)

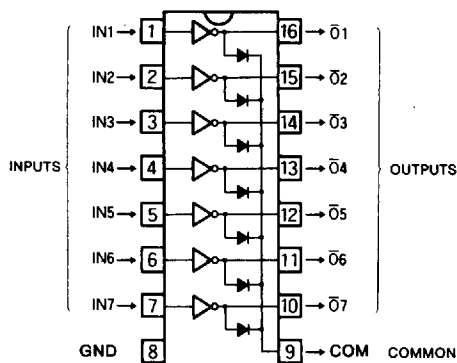

Outline 16P4

CIRCUIT SCHEMATIC

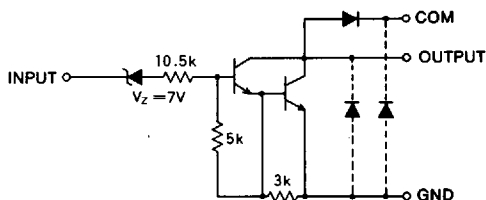

The diodes shown by broken line are parasite diodes and must not be used

Unit : Ω

ABSOLUTE MAXIMUM RATINGS ($T_a = -20 \sim +75^\circ\text{C}$, unless otherwise noted)

Symbol	Parameter	Conditions	Ratings	Unit
V_{CEO}	Output sustaining voltage	Transistor OFF	-0.5~+50	V
I_C	Collector current per channel	Transistor ON	500	mA
V_I	Input voltage		-0.5~+30	V
I_F	Clamp diode forward current		500	mA
V_R	Clamp diode reverse voltage		-0.5~+50	V
P_d	Power dissipation	$T_a = 25^\circ\text{C}$	1.47	W
T_{opr}	Operating temperature		-20~+75	$^\circ\text{C}$
T_{stg}	Storage temperature		-55~+125	$^\circ\text{C}$

7-UNIT 500mA DARLINGTON TRANSISTOR ARRAY WITH CLAMP DIODE

RECOMMENDED OPERATIONAL CONDITIONS ($T_a = -20 \sim +75^\circ\text{C}$, unless otherwise noted)

Symbol	Parameter		Limits			Unit
			Min	Typ	Max	
V_o	Output voltage		0		50	V
I_c	Collector current per channel	Percent duty cycle less than 8%	0		400	mA
		Percent duty cycle less than 30%	0		200	
V_{IH}	"H" Input voltage	$I_c = 400\text{mA}$	17		25	V
V_{IL}	"L" Input voltage		0		6	V

ELECTRICAL CHARACTERISTICS ($T_a = -20 \sim +75^\circ\text{C}$, unless otherwise noted)

Symbol	Parameter	Test conditions	Limits		Unit	
			Min	Typ*		Max
$I_{O(Leak)}$	Input leakage current	$V_{CE} = 50\text{V}$	$I_i = 0\text{mA}$		100	μA
			$V_i = 6\text{V}$		500	
$V_{CE(sat)}$	Output saturation voltage	$V_i = 17\text{V}, I_c = 400\text{mA}$		1.3	2.4	V
		$V_i = 17\text{V}, I_c = 200\text{mA}$		0.95	1.6	
I_i	Input current	$V_i = 17\text{V}$		0.85	1.8	mA
		$V_i = 25\text{V}$		1.6	3.2	
V_F	Clamp diode forward voltage	$I_F = 400\text{mA}$		1.5	2.4	V
I_R	Clamp diode leakage current	$V_R = 50\text{V}$			100	μA
h_{FE}	DC forward current gain	$V_{CE} = 4\text{V}, I_c = 350\text{mA}, T_a = 25^\circ\text{C}$	1000	2500		—

* : Typical values are at $T_a = 25^\circ\text{C}$.

TYPICAL CHARACTERISTICS

ALLOWABLE AVERAGE POWER DISSIPATION

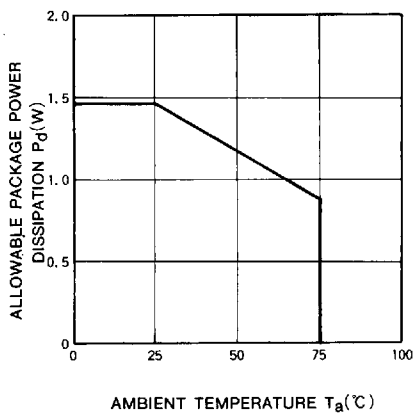

OUTPUT CURRENT CHARACTERISTICS

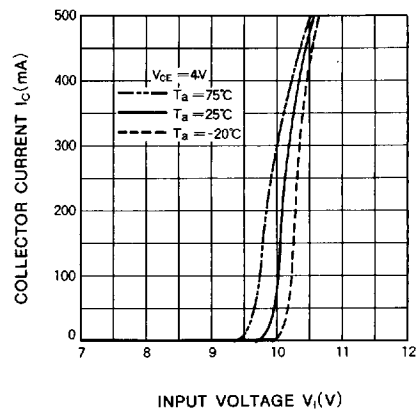

7-UNIT 500mA DARLINGTON TRANSISTOR ARRAY WITH CLAMP DIODE

ALLOWABLE COLLECTOR CURRENT AS A FUNCTION OF DUTY CYCLE

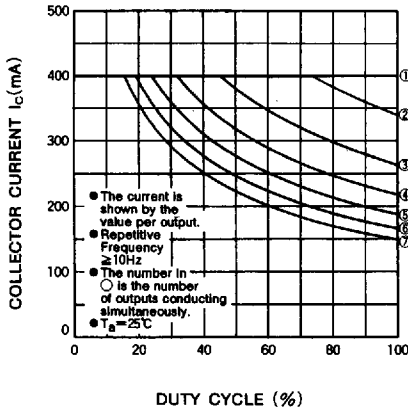

ALLOWABLE COLLECTOR CURRENT AS A FUNCTION OF DUTY CYCLE

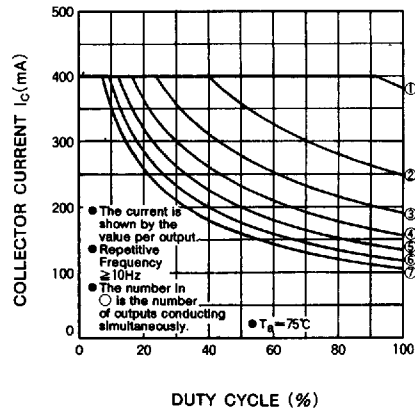

INPUT CHARACTERISTICS

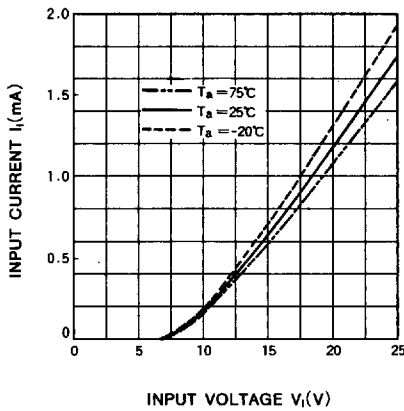

DC CURRENT GAIN CHARACTERISTICS

