

**29-FUNCTION REMOTE-CONTROL RECEIVER**

**DESCRIPTION**

The M58485P is a 29-function remote-control receiver circuit manufactured by aluminum-gate CMOS technology for use in television receivers, audio equipment, and the like using infrared for transmission. It enables direct control of 12 functions at the receiver.

The M58485P is intended for use with an M58480P or M58484P transmitter.

**FEATURES**

- Single power supply
- Wide supply voltage range: 8V~14V
- Low power dissipation
- On-chip oscillator
- Low-cost LC or ceramic oscillator used in determining reference frequency (480 kHz or 455 kHz)
- Information is transmitted by pulse code modulation
- Good noise immunity—instructions are not executed unless the same code is received three or more times in succession
- Single transmission frequency (40 kHz or 38 kHz) for carrier wave
- 16 TV channels selected directly
- Three analog functions—volume, brightness, and color saturation—are independently controlled to 64 stages by three 6-bit D/A converters.
- 12 instructions are controlled at the M58485P receiver, as well.
- Has large tolerance in operating frequency between the transmitter and the receiver
- Can be connected with an M51231P or equivalent touch-control channel selector

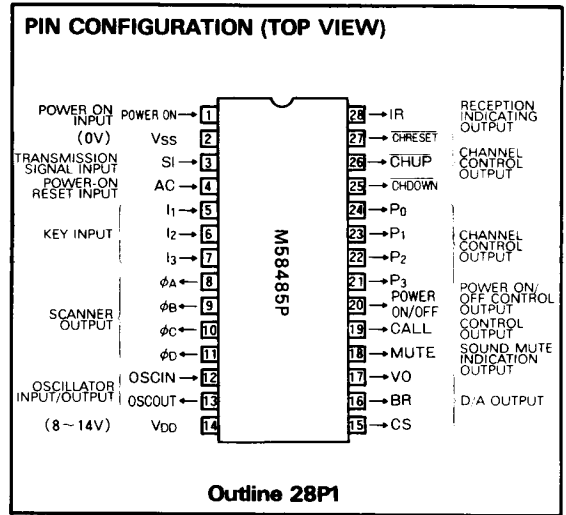

**APPLICATIONS**

- Remote-control receiver for TV or other applications

**FUNCTION**

The M58485P is designed to decode and execute instructions after three successive receptions of the identical instruction code, providing a good noise immunity.

Instructions comprise direction selection of 16 channels, channel position high and low, volume high and low, brightness high and low, color saturation high and low, normalization of volume, brightness and color saturation, sound mute on and off, TV main power on and off, and output CALL on and off.

In addition, 12 functional instructions can be entered from the receiver.

**BLOCK DIAGRAM**

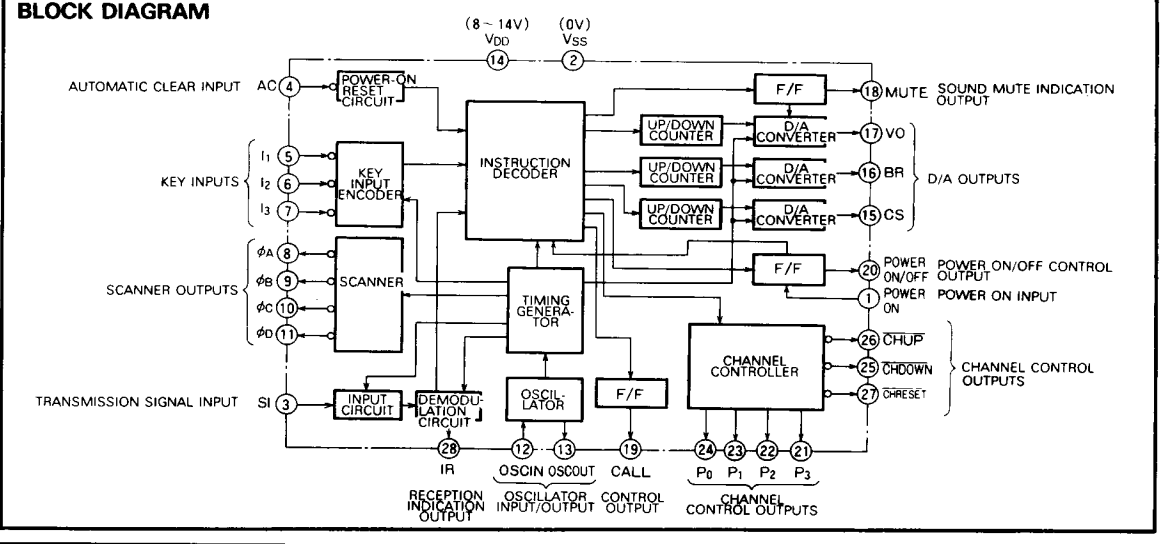

10

**29-FUNCTION REMOTE-CONTROL RECEIVER**

**FUNCTIONAL DESCRIPTION**

**Oscillator**

As the oscillator is on-chip, oscillation frequency is easily obtained by connecting an external LC network or a ceramic resonator between the OSC IN and OSC OUT terminals. Figs. 1 and 2 show typical oscillators.

**Fig. 1 An example of an oscillator (using ceramic resonator)**

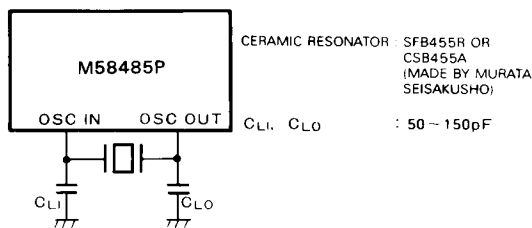

**Fig. 2 An example of an oscillator (using LC network)**

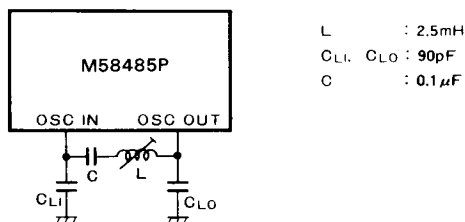

**Reception Signal Input Circuit and Demodulation Circuit**

The reception signal caught by the photo detector is amplified in the amplifier and added to the SI, where it is converted into a pulse signal in the input circuit to be sent to the demodulation circuit. In the demodulation circuit, the pulse interval of the pulse signal is judged and then converted into the digital code to be sent to the instruction decoder.

SI is applied as amplified either through a capacitor coupling (Fig. 3) or directly as a pulse signal (Figs. 4 and 5). A Schmitt trigger circuit is provided in the SI input circuit for preventing spurious operation due to noise.

**Fig. 3 SI input waveform (when applied through a capacitor coupling)**

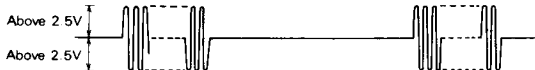

**Fig. 4 SI input waveform (when applied directly)**

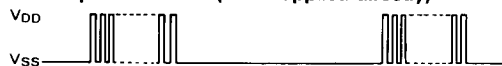

**Fig. 5 SI input waveform (when applied directly)**

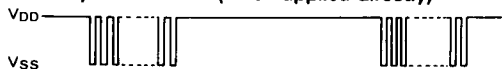

**Instruction Decoder**

The instruction decoder starts to function after receiving the same instruction code three or more times in succession from the demodulation circuit.

Table 1 shows the relations between the reception code and instruction function. To prevent spurious operation, there is no code 000000.

**Table 1 Relations between reception codes and instructions**

Reception code						Function	Remarks
D <sub>1</sub>	D <sub>2</sub>	D <sub>3</sub>	D <sub>4</sub>	D <sub>5</sub>	D <sub>6</sub>		
1	0	0	0	0	0	CH UP	Channel up
0	1	0	0	0	0	CH DOWN	Channel down
1	1	0	0	0	0	VO UP	Analog control
0	0	1	0	0	0	VO DOWN	
1	0	1	0	0	0	BR UP	
0	1	1	0	0	0	BR DOWN	
1	1	1	0	0	0	CS UP	Normalization of analog control
0	0	0	1	0	0	CS DOWN	
1	0	0	1	0	0	MUTE	Sound mute on/off
0	1	0	1	0	0	VO(1/3)	Normalization of analog control
1	1	0	1	0	0	BR(1/2), CS(1/2)	
1	0	1	1	0	0	CALL	Output CALL on/off
0	1	1	1	0	0	POWER ON/OFF	Power on/off
0	0	0	0	1	0	CH 1	Channels selected directly
1	0	0	0	1	0	CH 2	
0	1	0	0	1	0	CH 3	
1	1	0	0	1	0	CH 4	
0	0	1	0	1	0	CH 5	
1	0	1	0	1	0	CH 6	
0	1	1	0	1	0	CH 7	
1	1	1	0	1	0	CH 8	
0	0	0	1	1	0	CH 9	
1	0	0	1	1	0	CH 10	
0	1	0	1	1	0	CH 11	
1	1	0	1	1	0	CH 12	
0	0	1	1	1	0	CH 13	
1	0	1	1	1	0	CH 14	
0	1	1	1	1	0	CH 15	
1	1	1	1	1	0	CH 16	

**Key Inputs**

It is possible to input 12 different instructions by the 3 x 4 keyboard matrix consisting of inputs I<sub>0</sub>~I<sub>3</sub> and scanner outputs φA~φD. Protection is also available against chattering within 10ms.

As entry priority is given to each key, depression of more than two keys at the same time makes the key with higher priority effective. For the scanner output, priority is given in the order of φA, φB, φC, and φD, and in the order of I<sub>1</sub>, I<sub>2</sub>, and I<sub>3</sub> if scanner output is the same. When two or more keys are depressed at the same time, scanner outputs may short-circuit, disabling all functions.

While one of the keys is depressed, instructions from the transmitter are ignored.

Table 2 shows the relations between the keyboard matrix and the commands.

29-FUNCTION REMOTE-CONTROL RECEIVER

Table 2 Relations between keyboard matrix and instructions

Scanner output Key input	$\phi D$	$\phi C$	$\phi B$	$\phi A$
I <sub>1</sub>	CH UP	VO UP	BR UP	CS UP
I <sub>2</sub>	CH DOWN	VO DOWN	BR DOWN	CS DOWN
I <sub>3</sub>	POWER ON/OFF	MUTE	VO(1/3) BR(1/2) CS(1/2)	CALL

Indication of Reception

As soon as an identical code is received three times, the output IR turns from low-level to high-level. Thus reception of a command from the transmitter can be indicated by an LED connected to output IR.

Analog Outputs (CO, BR, CS)

As three 6-bit D/A converters are contained internally, three kinds of analog values can be controlled to 64 stages independently. The D/A converters are pulse-width modulator, and the repetition frequency is 1.25 kHz (when  $f_{osc}=480$  kHz) and minimum pulse width is 12.5 $\mu$ s.

Analog values can be incremented/decremented at a rate of about 1 step/0.1 sec through the remote control or the key input. The time required for increasing the analog value from the minimum to the maximum is about 6.6 seconds (when  $f_{osc}=480$  kHz).

It is also possible to set the analog values to 1/3 (VO), 1/2 (BR, CS) of these maximum values by means of the remote control or the key input (normalization).

Sound Mute

Sound mute on/off is controlled through the remote control or the key input. When sound mute is on, output VO goes low, and output MUTE goes high.

Sound mute is automatically released from ON when VO is either incremented or decremented by remote control or the key input.

Channel Control

It is possible to employ either of two channel control methods: parallel control by outputs P<sub>0</sub>~P<sub>3</sub>, and serial control by outputs CH UP, CH DOWN, and CH RESET.

In parallel control, a 4-bit address corresponding to a selected channel number appears at output P<sub>0</sub>~P<sub>3</sub>. Table 3 shows the relations between channel numbers and outputs P<sub>0</sub>~P<sub>3</sub>.

In serial control, a single pulse appears on the output CH RESET first, and then the pulses whose number is deducted by one from the selected channel number appear on the output CH UP, as shown in Fig. 6. Up and down channel switching is controlled by a single pulse appearing at output CH UP or CH DOWN, allowing connection to the M51231P or equivalent touch-control channel selector IC.

Table 3 Relations between channel number and address output P<sub>0</sub>~P<sub>3</sub>.

Channel number	Address outputs			
	P <sub>0</sub>	P <sub>1</sub>	P <sub>2</sub>	P <sub>3</sub>
1	0	0	0	0
2	1	0	0	0
3	0	1	0	0
4	1	1	0	0
5	0	0	1	0
6	1	0	1	0
7	0	1	1	0
8	1	1	1	1
9	0	0	0	1
10	1	0	0	1
11	0	1	0	1
12	1	1	0	1
13	0	0	1	1
14	1	0	1	1
15	0	1	1	1
16	1	1	1	1

Fig. 6 Timing chart of serially controlled channel selection (when  $f_{osc}=480$ kHz)

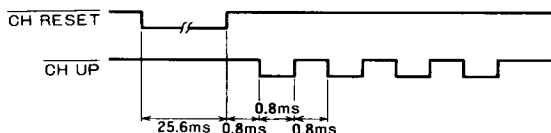

During direct channel selection or up-down channel switching, output VO goes low for 25~50ms.

Outputs CH UP, CH DOWN, CH RESET, and P<sub>0</sub>~P<sub>3</sub>, are the open-drain type of N-channel transistor.

Power on/off

The remote control or the key input makes it possible to turn the POWER ON/OFF output from low to high or vice versa, and it is possible to change the POWER ON/OFF output from low to high by means of the POWER ON input.

While POWER ON/OFF is low, all channel and analog controls through the remote control are disabled, as are all through the keyboard.

Output CALL

The output CALL is turned high or low by remote control or the key input. This output effects on/off control of channel number indication or change of receiving modes of multi-channel broadcasting.

Power-on Reset

Attaching a capacitor to terminal AC activates the power-on reset function when power is on to the M58485P.

Activation of the power-on reset function sets outputs VO, BR, and CS to 1/3, 1/2, and 1/2, respectively, of their maximum value, turns POWER ON/OFF and CALL outputs low and turns outputs P<sub>0</sub>~P<sub>3</sub> to 0000.

10

**29-FUNCTION REMOTE-CONTROL RECEIVER**

**ABSOLUTE MAXIMUM RATINGS**

Symbol	Parameter	Conditions	Limits	Unit
V <sub>DD</sub>	Supply voltage	With respect to V <sub>SS</sub>	-0.3 ~ 15	V
V <sub>I</sub>	Input voltage		V <sub>SS</sub> ≤ V <sub>I</sub> ≤ V <sub>DD</sub>	—
V <sub>O</sub>	Output voltage		V <sub>SS</sub> ≤ V <sub>O</sub> ≤ V <sub>DD</sub>	—
P <sub>d</sub>	Maximum power dissipation	T <sub>a</sub> = 25°C	300	mW
T <sub>opr</sub>	Operating free-air temperature range		-30 ~ 70	°C
T <sub>stg</sub>	Storage temperature range		-40 ~ 125	°C

**RECOMMENDED OPERATING CONDITIONS**

Symbol	Parameter	Limits			Unit
		Min	Nom	Max	
V <sub>DD</sub>	Supply voltage	8	12	14	V
f <sub>osc</sub>	Oscillation frequency		455		kHz
			480		kHz
V <sub>I</sub>	Input voltage, SI	5			V <sub>P-P</sub>

**ELECTRICAL CHARACTERISTICS** (T<sub>a</sub> = 25°C, V<sub>DD</sub> = 12V, unless otherwise noted)

Symbol	Parameter	Test conditions	Limits			Unit
			Min	Typ	Max	
V <sub>DD</sub>	Supply voltage	T <sub>a</sub> = -30 ~ 70°C, f <sub>osc</sub> = 455kHz	8	12	14	V
I <sub>DD</sub>	Supply current	f <sub>osc</sub> = 455kHz		2	5	mA
R <sub>I</sub>	Pull-up resistance, I <sub>1</sub> ~ I <sub>3</sub>			20		kΩ
I <sub>OL</sub>	Low-level output currents, φA ~ φD	V <sub>O</sub> = 12V	5			mA
I <sub>OL</sub>	Low-level output currents, CH UP, CH DOWN, CH RESET	V <sub>O</sub> = 12V	20			mA
I <sub>OZH</sub>	Off-state output currents, CH UP, CH DOWN, CH RESET	V <sub>O</sub> = 12V			1	μA
I <sub>OL</sub>	Low-level output currents, P <sub>0</sub> ~ P <sub>3</sub>	V <sub>O</sub> = 12V	20			mA
I <sub>OZH</sub>	Off-state output currents, P <sub>0</sub> ~ P <sub>3</sub>	V <sub>O</sub> = 12V			1	μA
I <sub>OH</sub>	High-level output currents, VO, BR, CS	V <sub>O</sub> = 0 V	-7			mA
I <sub>OL</sub>	Low-level output currents, VO, BR, CS	V <sub>O</sub> = 12V	7			mA
I <sub>OH</sub>	High-level output currents, POWER ON/OFF, CALL, MUTE	V <sub>O</sub> = 0 V	-20			mA
I <sub>OL</sub>	Low-level output currents, POWER ON/OFF, CALL, MUTE	V <sub>O</sub> = 12V	5			mA
I <sub>OH</sub>	High-level output current, IR	V <sub>O</sub> = 0 V	-15			mA
I <sub>OL</sub>	Low-level output current, IR	V <sub>O</sub> = 12V	5			mA

**An example of an application circuit**

