

GTR Module

Silicon N Channel IGBT

High Power Switching Applications

Motor Control Applications

Features

- 6 IGBTs are built into 1 package
- High speed: $t_f = 0.35\mu\text{s}$ (Max.) ($I_C = 25\text{A}$)
 $t_{rr} = 0.15\mu\text{s}$ (Max.) ($I_F = 25\text{A}$)
- Low saturation voltage: $V_{CE(sat)} = 3.5\text{V}$ (Max.) ($I_C = 25\text{A}$)
- Enhancement mode
- The electrodes are isolated from case

Maximum Ratings ($T_a = 25^\circ\text{C}$)

CHARACTERISTIC	SYMBOL	RATING	UNIT
Collector-Emitter Voltage	V_{CES}	600	V
Gate-Emitter Voltage	V_{GES}	± 20	V
Collector Current	DC	I_C	25
	1ms	I_{CP}	50
Forward Current	DC	I_F	25
	1ms	I_{FM}	50
Collector Power Dissipation ($T_c = 25^\circ\text{C}$)	P_C	100	W
Junction Temperature	T_j	150	$^\circ\text{C}$
Storage Temperature Range	T_{stg}	-40 ~ 125	$^\circ\text{C}$
Isolation Voltage	V_{isol}	2500 (AC 1 Minute)	V
Screw Torque	—	3	N ¥ m

Unit in mm

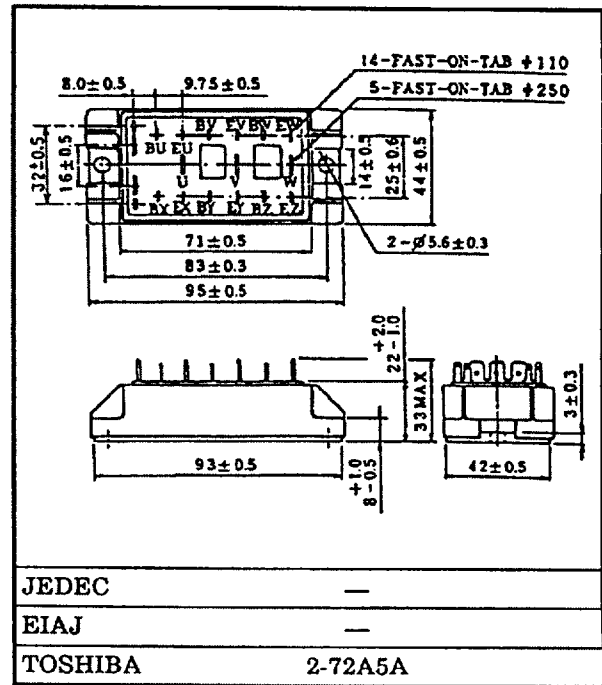

Weight : 225g

9097250 0021909 203

Equivalent Circuit

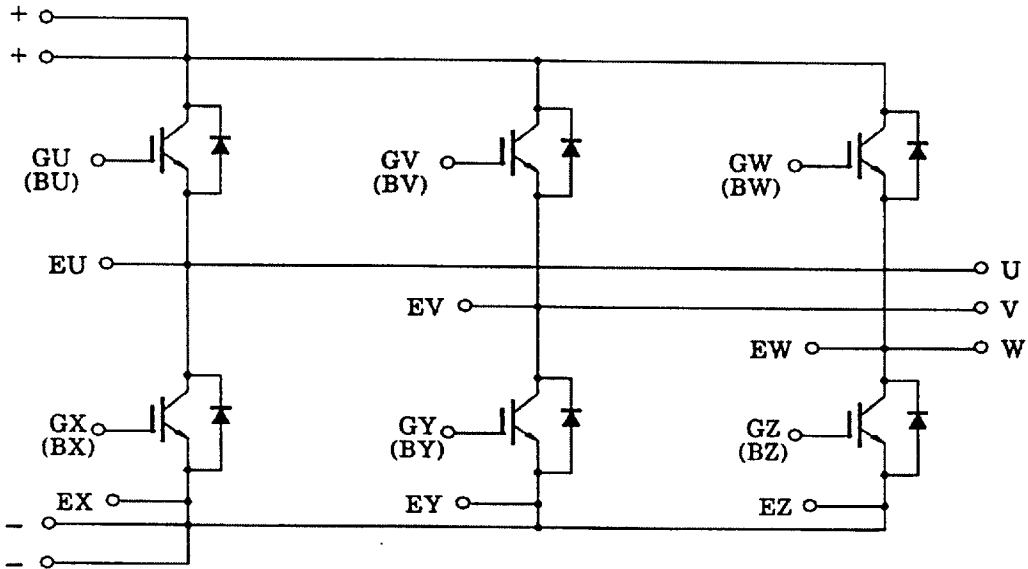

Electrical Characteristics (Ta = 25°C)

CHARACTERISTIC	SYMBOL	TEST CONDITION	MIN.	TYP.	MAX.	UNIT
Gate Leakage Current	I_{GES}	$V_{GE} = \pm 20V, V_{CE} = 0$	—	—	± 500	nA
Collector Cut-off Current	I_{CES}	$V_{CE} = 600V, V_{GE} = 0$	—	—	1.0	mA
Collector-Emitter Breakdown Voltage	$V_{(BR) CES}$	$I_C = 10mA, V_{GE} = 0$	600	—	—	V
Gate-Emitter Cut-off Voltage	$V_{GE (OFF)}$	$I_C = 25mA, V_{CE} = 5V$	3.0	—	6.0	V
Collector-Emitter Saturation Voltage	$V_{CE (sat)}$	$I_C = 25A, V_{GE} = 15V$	—	2.7	3.5	V
Input Capacitance	C_{ies}	$V_{CE} = 10V, V_{GE} = 0, f = 1MHz$	—	2000	—	pF
Switching Time	Rise Time	t_r	—	0.3	0.6	μs
	Turn-on Time	t_{on}	—	0.4	0.8	
	Fall Time	t_f	—	0.18	0.35	
	Turn-off Time	t_{off}	—	0.60	1.0	
Forward Voltage	V_F	$I_F = 25A, V_{GE} = 0$	—	1.7	2.5	V
Reverse Recovery Time	t_{rr}	$I_F = 25A, V_{GE} = -10V, di/dt = 50A/\mu s$	—	0.08	0.15	μs
Thermal Resistance	$R_{th (j - c)}$	Transistor	—	—	1.25	$^{\circ}C/W$
		Diode	—	—	1.56	

9097250 0021910 T25

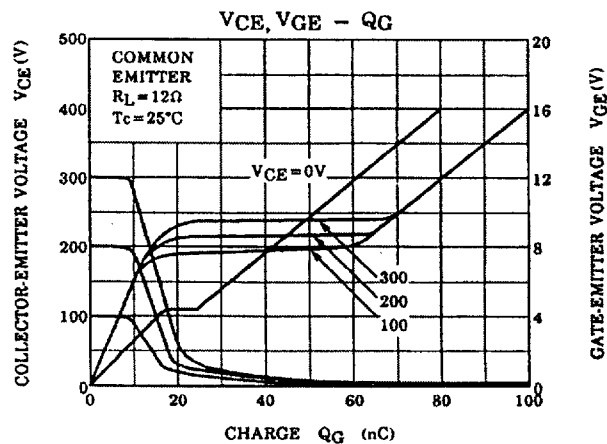
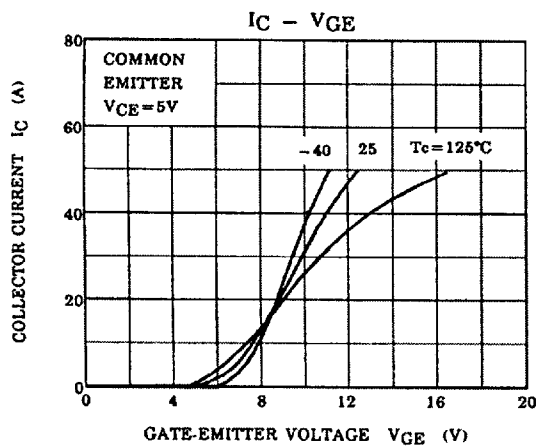
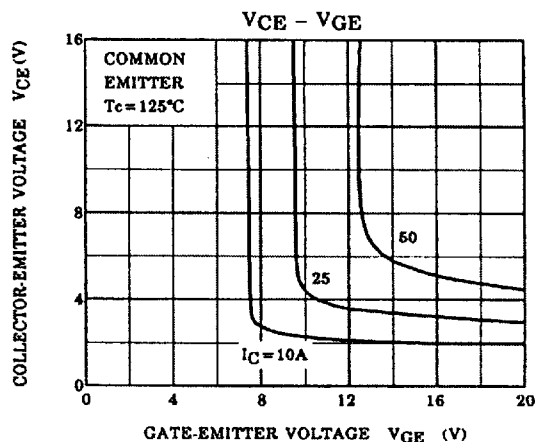
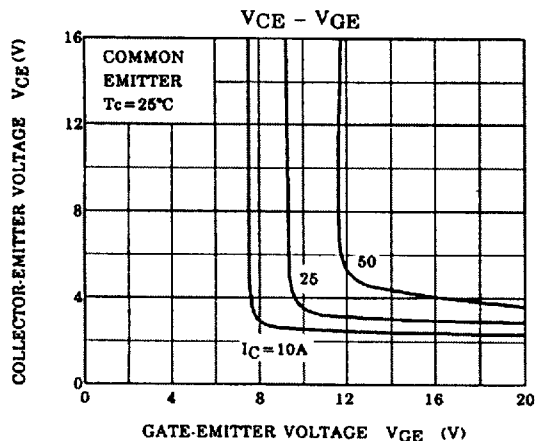
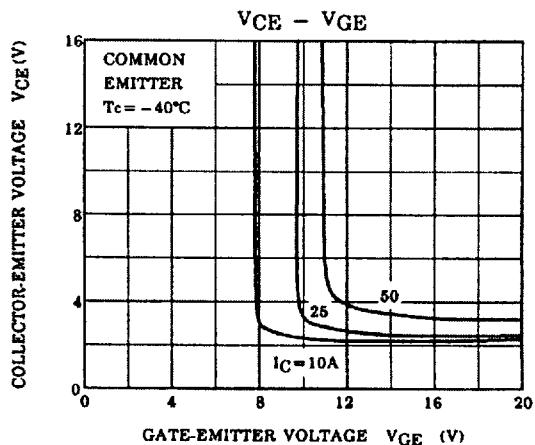
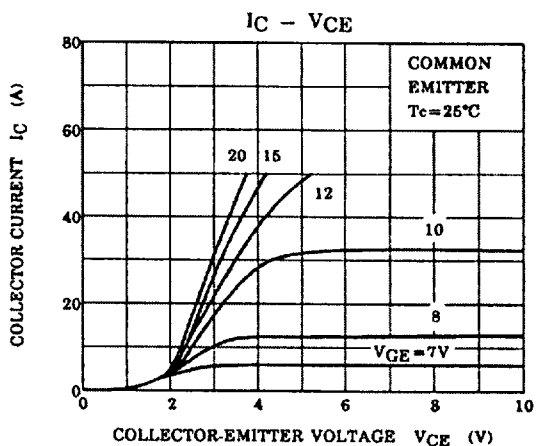

9097250 0021911 961

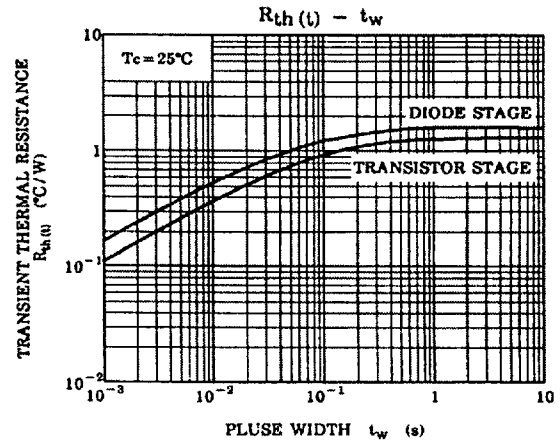
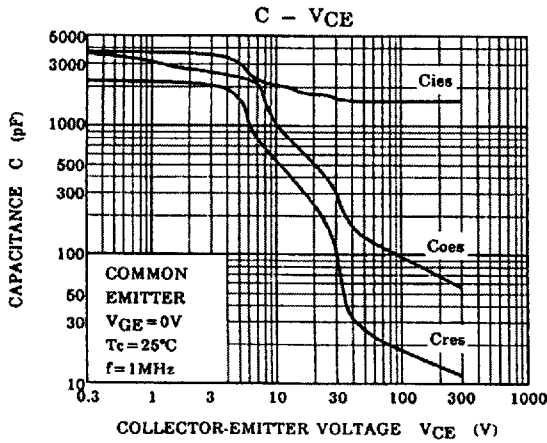
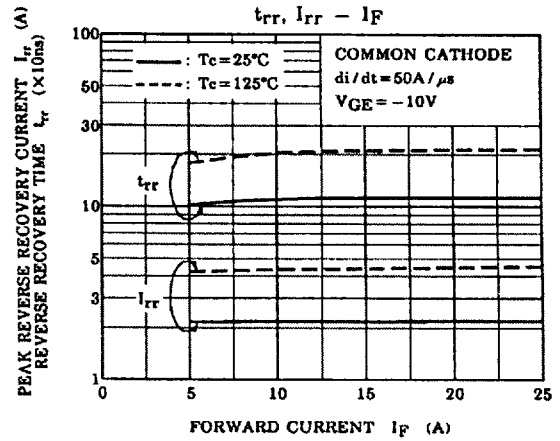
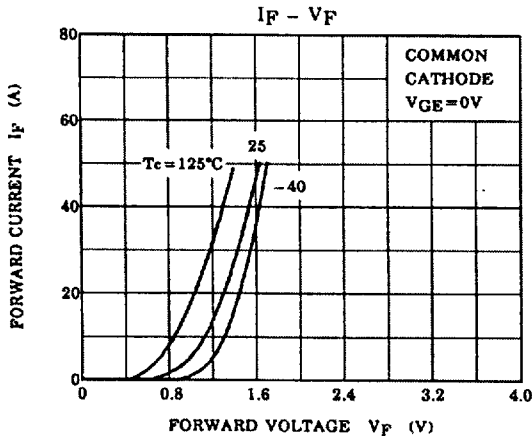
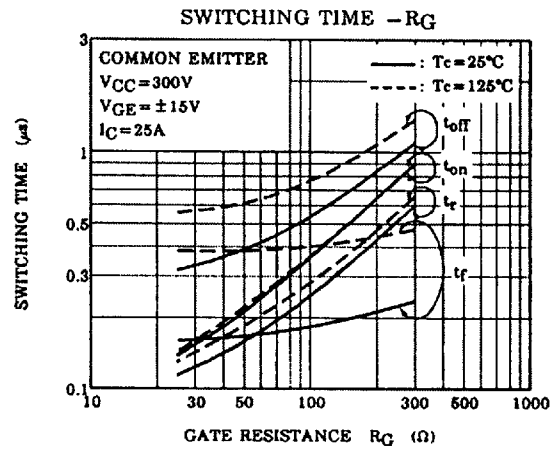
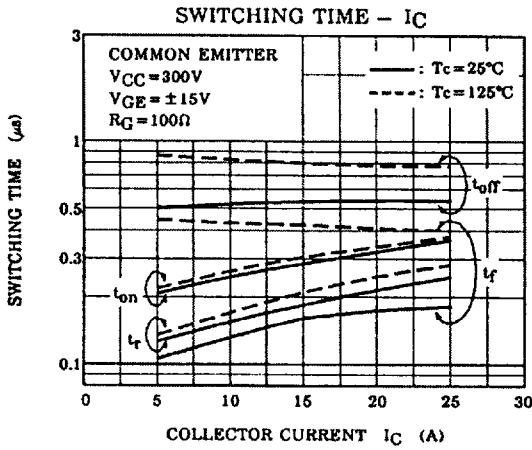

9097250 0021912 8T8

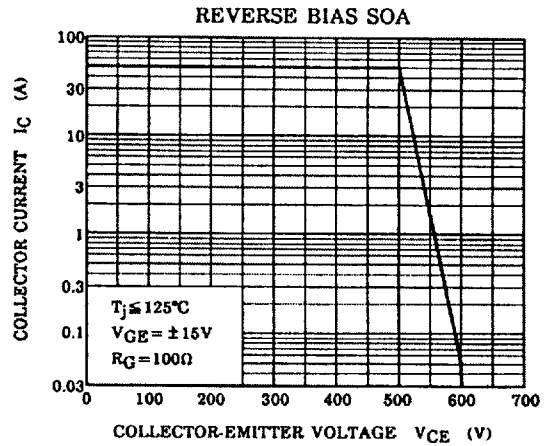
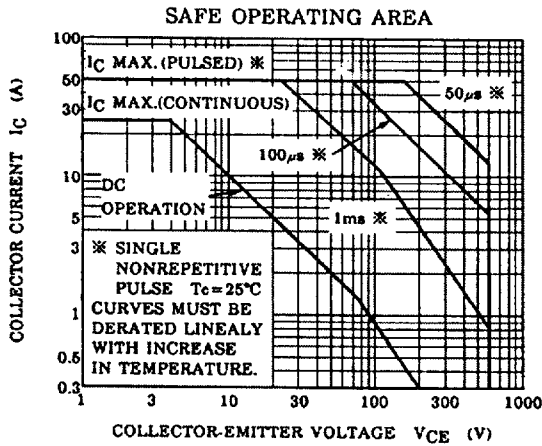

The information contained here is subject to change without notice.

The information contained herein is presented only as guide for the applications of our products. No responsibility is assumed by TOSHIBA for any infringements of patents or other rights of the third parties which may result from its use. No license is granted by implication or otherwise under any patent or patent rights of TOSHIBA or others. These TOSHIBA products are intended for usage in general electronic equipments (office equipment, communication equipment, measuring equipment, domestic electrification, etc.) Please make sure that you consult with us before you use these TOSHIBA products in equipments which require high quality and/or reliability, and in equipments which could have major impact to the welfare of human life (atomic energy control, spaceship, traffic signal, combustion control, all types of safety devices, etc.). TOSHIBA cannot accept liability to any damage which may occur in case these TOSHIBA products were used in the mentioned equipments without prior consultation with TOSHIBA.