

TOSHIBA

INSULATED GATE BIPOLAR TRANSISTOR

MG8J6ES1

Unit in mm

High Power Switching Applications

Motor Control Applications

- The Electrodes are Isolated from Case.
- 6 IGBTs are Built Into 1 Package.
- Enhancement-Mode
- Low Saturation Voltage
 - : $V_{CE(sat)} = 4.0V$ (Max.)
- High Speed
 - : $t_f = 0.35\mu s$ (Max.)
 - : $t_{rr} = 0.25\mu s$ (Max.)

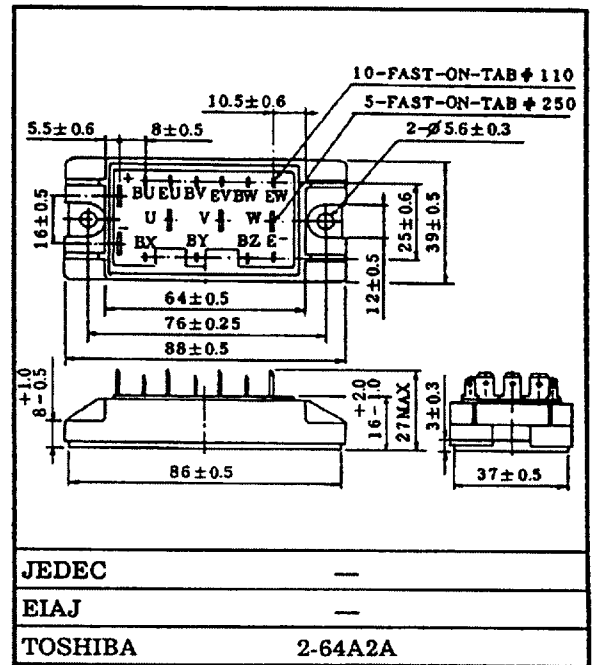

Weight : 152g

Equivalent Circuit

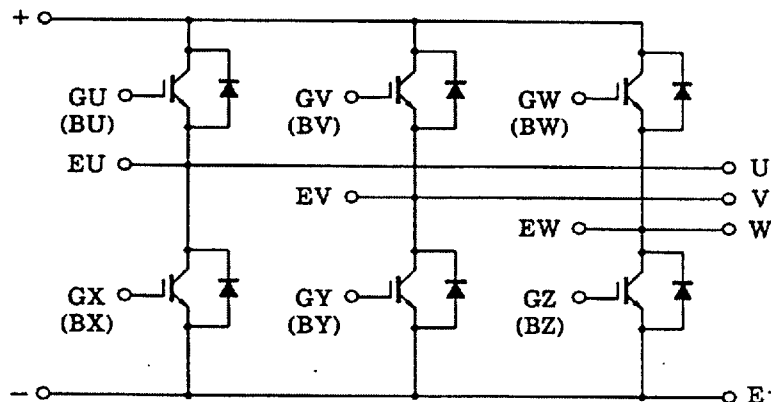

The information contained here is subject to change without notice.

The information contained herein is presented only as guide for the applications of our products. No responsibility is assumed by TOSHIBA for any infringements of patents or other rights of the third parties which may result from its use. No license is granted by implication or otherwise under any patent or patent rights of TOSHIBA or others. These TOSHIBA products are intended for usage in general electronic equipments (office equipment, communication equipment, measuring equipment, domestic electrification, etc.) Please make sure that you consult with us before you use these TOSHIBA products in equipments which require high quality and/or reliability, and in equipments which could have major impact to the welfare of human life (atomic energy control, spaceship, traffic signal, combustion control, all types of safety devices, etc.). TOSHIBA cannot accept liability to any damage which may occur in case these TOSHIBA products were used in the mentioned equipments without prior consultation with TOSHIBA.

TOSHIBA CORPORATION

9097250 0021890 307

PW03260796

1/5

MG8J6ES1

Maximum Ratings (Ta = 25°C)

CHARACTERISTIC		SYMBOL	RATINGS	UNIT
Collector-Emitter Voltage		V_{CES}	600	V
Gate-Emitter Voltage		V_{GES}	±20	V
Collector Current	DC	I_C	8	A
	1ms	I_{CP}	16	
Forward Current	DC	I_F	8	A
	1ms	I_{FM}	16	
Collector Power Dissipation (Tc = 25°C)		P_C	50	W
Junction Temperature		T_j	150	°C
Storage Temperature Range		T_{stg}	-40 ~ 125	°C
Isolation Voltage		V_{Isol}	2500 (AC 1 minute)	V
Screw Torque		-	3	N•m

Electrical Characteristics (Ta = 25°C)

CHARACTERISTIC		SYMBOL	TEST CONDITION	MIN.	TYP.	MX.	UNIT
Gate Leakage Current		I_{GES}	$V_{GE} = \pm 20V, V_{CE} = 0$	-	-	±500	nA
Collector Cut-off Current		I_{CES}	$V_{CE} = 600V, V_{GE} = 0$	-	-	1.0	mA
Gate-Emitter Cut-off Voltage		$V_{GE(OFF)}$	$I_C = 8mA, V_{CE} = 5V$	3.0	-	6.0	V
Collector-Emitter Saturation Voltage		$V_{CE(sat)}$	$I_C = 8A, V_{GE} = 15V$	-	3.0	4.0	V
Input Capacitance		C_{ies}	$V_{CE} = 10V, V_{GE} = 0, f = 1MHz$	-	650	-	pF
Switching Time	Rise Time	t_r		-	0.3	0.6	μs
	Turn-on Time	t_{on}		-	0.4	0.8	
	Fall Time	t_f		-	0.15	0.35	
	Turn-off Time	t_{off}		-	0.5	1.0	
Forward Voltage		V_F	$I_F = 8A, V_{GE} = 0$	-	1.5	2.5	V
Reverse Recovery Time		t_{rr}	$I_F = 8A, V_{GE} = -10V$ $di/dt = 50A/\mu s$	-	0.15	0.25	μs
Thermal Resistance		$R_{th(j-c)}$	Transistor	-	-	2.50	°C/W
			Diode	-	-	2.80	

9097250 0021891 243

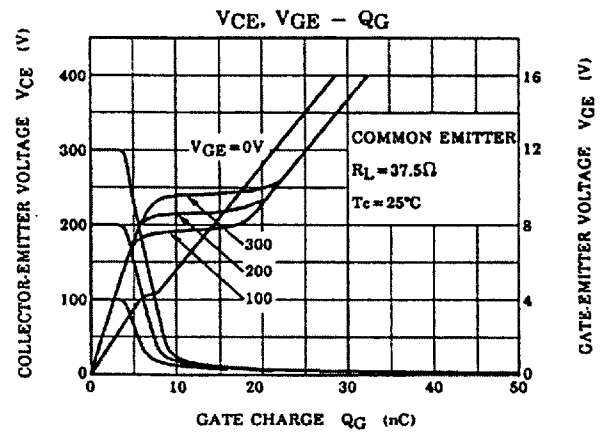
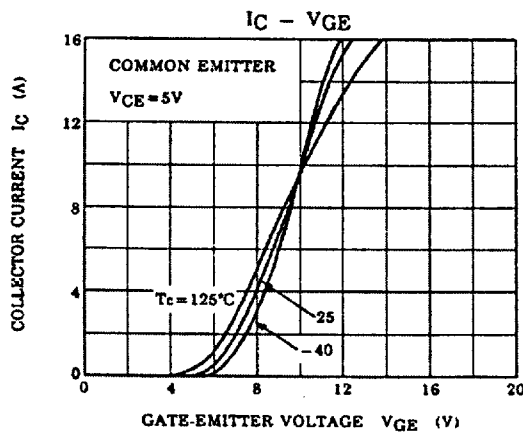
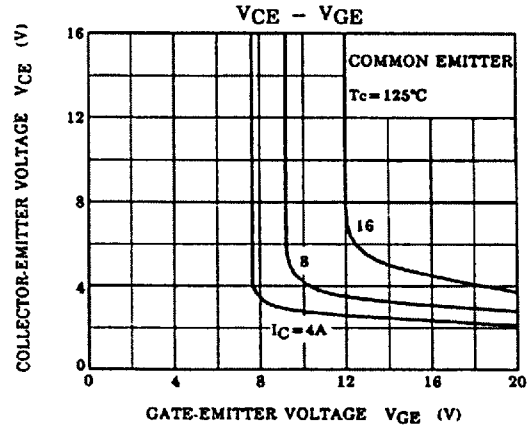
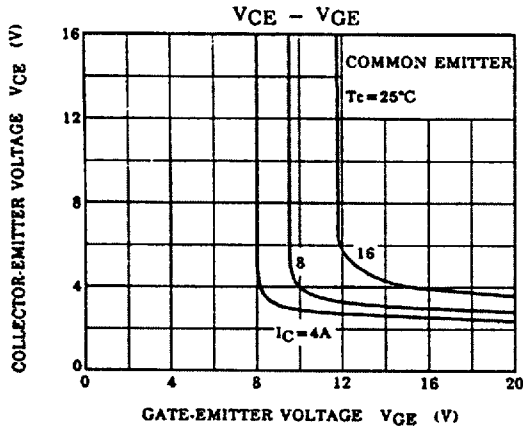
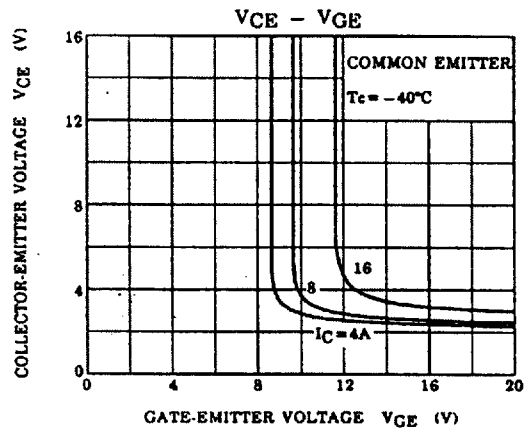
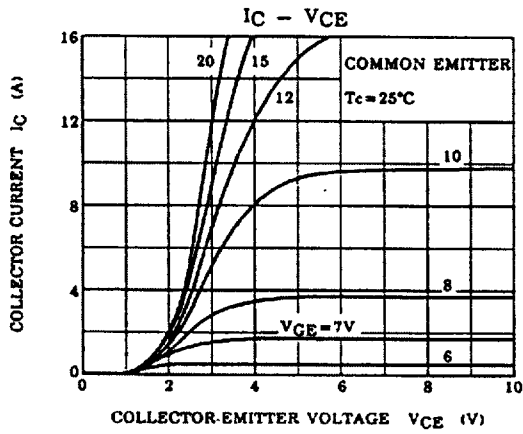

9097250 0021892 18T

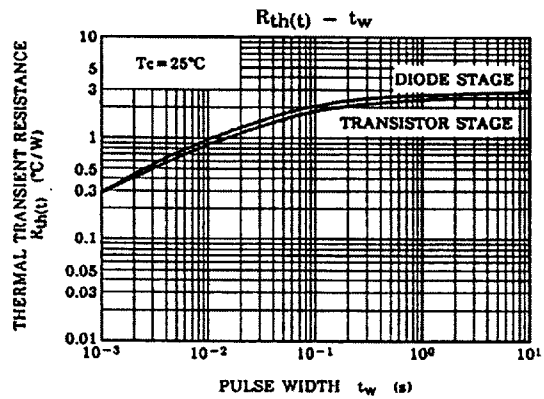
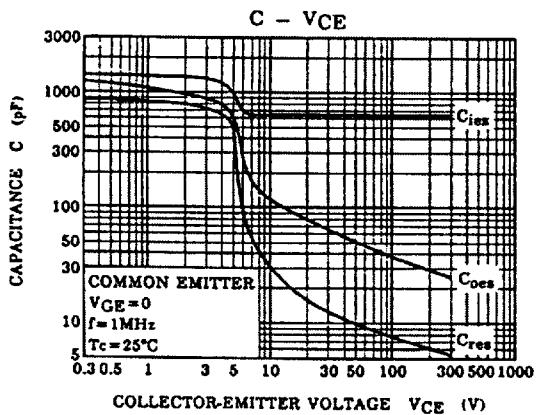
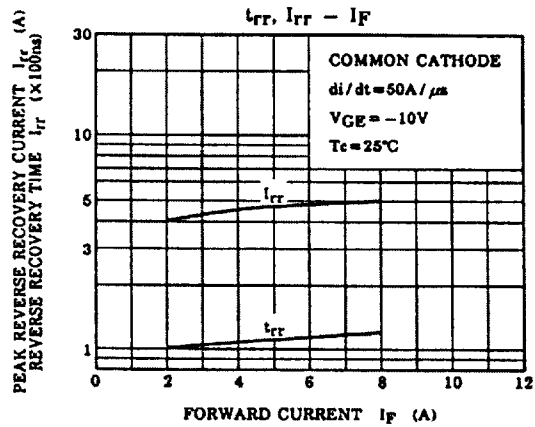
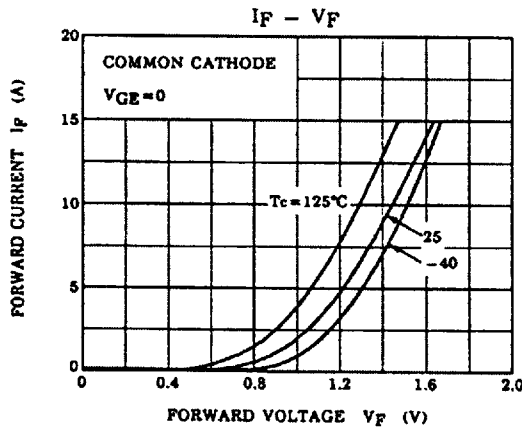
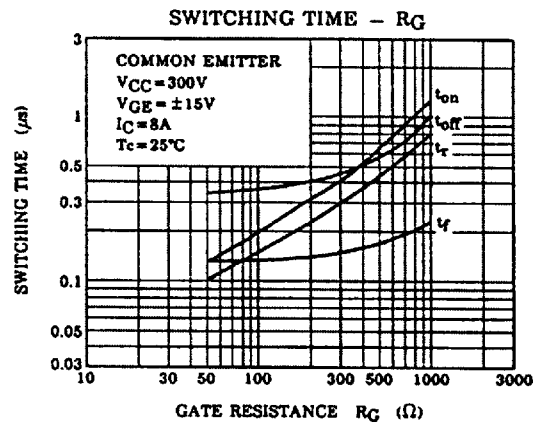
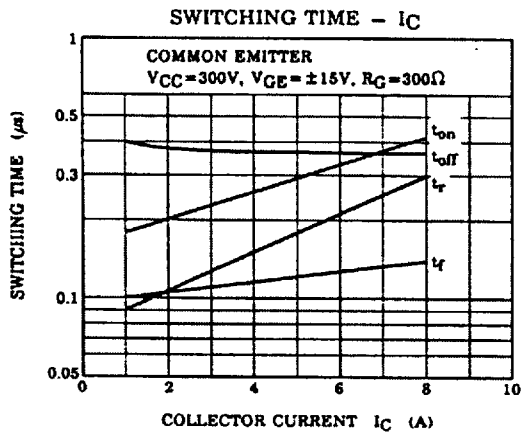

9097250 0021893 016

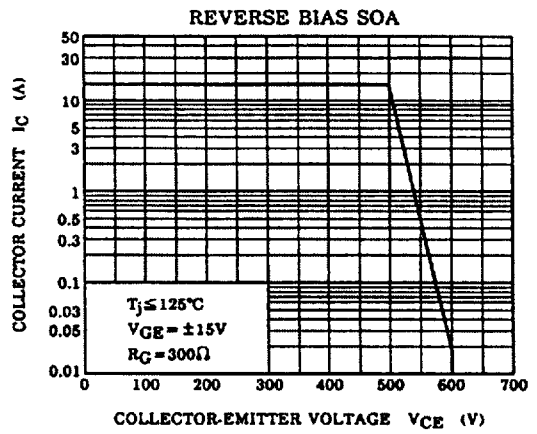
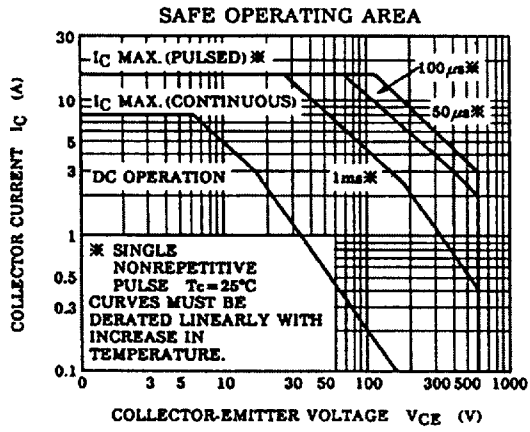

9097250 0021894 T52