

DC MOTOR SPEED CONTROLLER

The KA2404 is a monolithic integrated circuit designed for DC motor speed controllers.

FEATURES

- Suitable for DC motor speed controllers of cassette tape recorders and radio cassettes.
- Excellent stability of each characteristics against ambient temperature.
- High output current.
- Low quiescent current (1.3mA: typ).
- Low reference voltage.
- Wide operating supply voltage range ($V_{CC} = 4V \sim 12V$)
- KA2404A: TO-126 PKG type

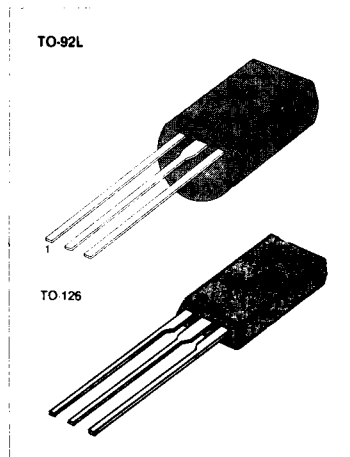

3

EQUIVALENT CIRCUIT BLOCK DIAGRAM

ORDERING INFORMATION

Device	Package	Operating Temperature
KA2404	TO-92L	-20°C ~ +70°C
KA2404A	TO-126	

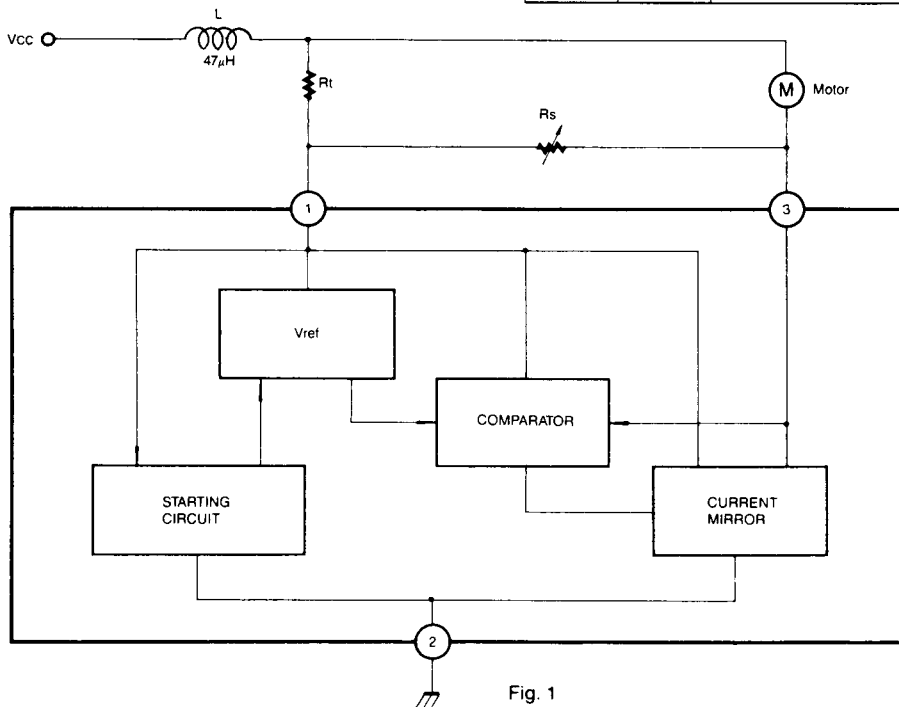

Fig. 1

ABSOLUTE MAXIMUM RATINGS (Ta = 25°C)

Characteristics	Symbol	Value	Unit
Supply Voltage	V _{CC}	16	V
Circuit Current	I ₃	2 (Note 1)	A
Power Dissipation (TO-126)	P _D (TO-92L) 1.3 (Note 2)	800 W	mW
Operating Temperature	T _{OPR}	-20 ~ +70	°C
Storage Temperature	T _{STG}	-40 ~ +125	°C

Note 1: 5 > 5 sec

Note 2: Ta = 25°C, with a 100 × 100mm bakelite printed circuit board (35μ Cu leaf)

ELECTRICAL CHARACTERISTICS

(Ta = 25°C, V_{CC} = 9V, unless otherwise specified)

Characteristic	Symbol	Test Conditions	Min	Typ	Max	Unit	Fig
Reference Voltage	V _{REF}	I ₃ = 10mA	1.10	1.27	1.40	V	2
Quiescent Circuit Current	I _{CCQ}	R _m = 180Ω	0.8	1.3	1.8	mA	4
Current Coefficient	K	R _{m1} = 44Ω R _{m2} = 33Ω	16	18	20		3
Voltage Characteristic of Current Coefficient	$\frac{\Delta K}{K} / \Delta V_{CC}$	I ₃ = 100mA V _{CC} = 4 ~ 12V		0.4		%/V	3
Voltage Characteristic of Reference Voltage	$\frac{\Delta V_{REF}}{V_{REF}} / \Delta V_{CC}$	I ₃ = 100mA V _{CC} = 4 ~ 12V		0.06		%/V	2
Current Characteristic of Current Coefficient	$\frac{\Delta K}{K} / \Delta I_3$	I ₃ = 30 ~ 200mA		-0.02		%/mA	3
Current Characteristic of Reference Voltage	$\frac{\Delta V_{REF}}{V_{REF}} / \Delta I_3$	I ₃ = 30 ~ 200mA		-0.02		%/mA	2
Temperature Characteristics of Current Coefficient	$\frac{\Delta K}{K} / \Delta T_a$	I ₃ = 100mA T _a = -20 ~ +75°C		0.01		%/°C	3
Temperature Characteristics of Reference Voltage	$\frac{\Delta V_{REF}}{V_{REF}} / \Delta T_a$	I ₃ = 100mA T _a = -20 ~ +75°C		0.01		%/°C	2

TEST CIRCUIT 1
Reference Voltage

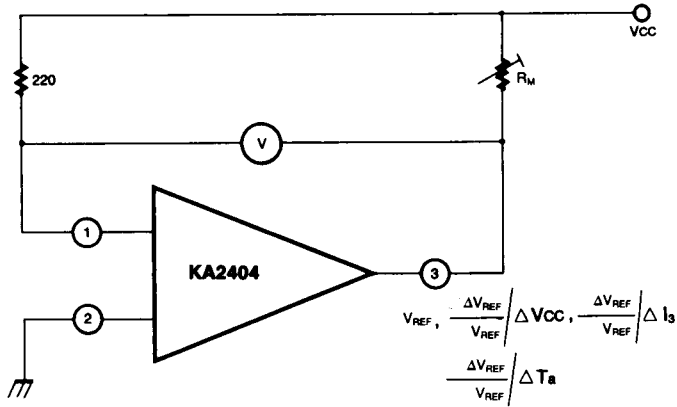

Fig. 2

TEST CIRCUIT 2
Current Coefficient

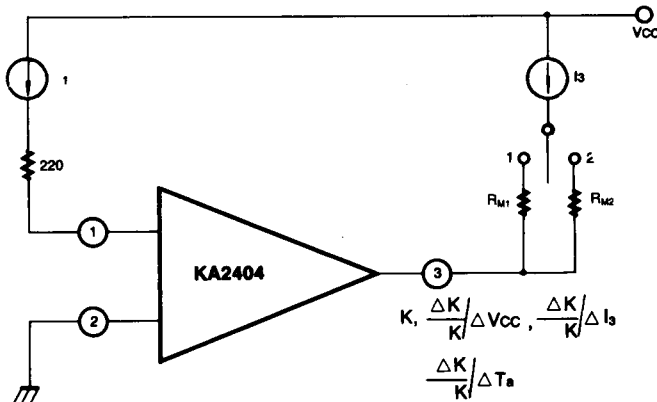

Fig. 3

$$K = \frac{I_3 (SW 2) - (SW 1)}{I_1 (SW 2) - (SW 1)}$$

TEST CIRCUIT 3

Quiescent Circuit Current

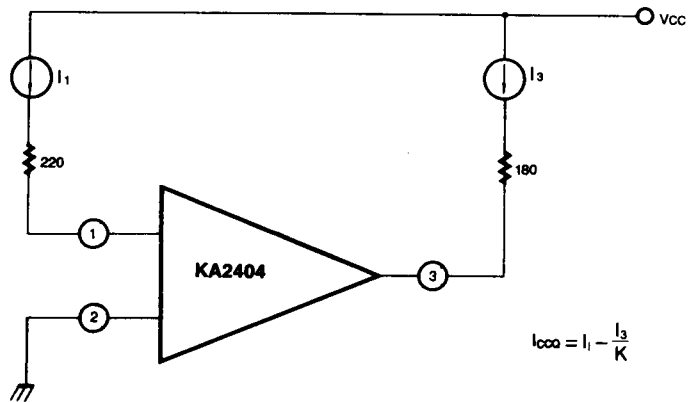
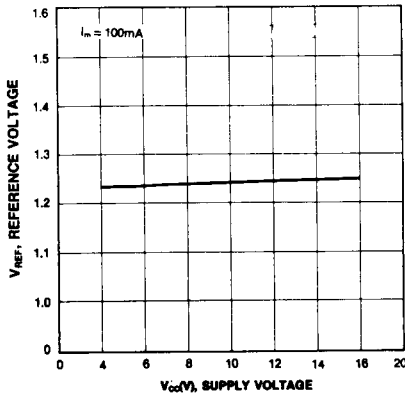
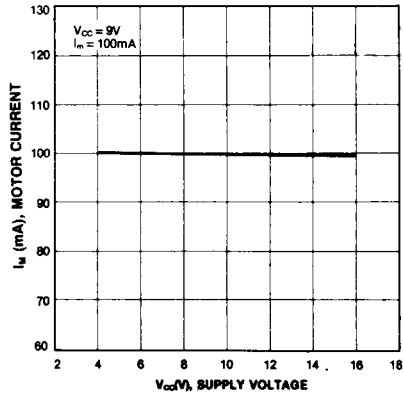

Fig. 4

REFERENCE VOLTAGE-SUPPLY VOLTAGE



MOTOR CURRENT-SUPPLY VOLTAGE



CURRENT COEFFICIENT-SUPPLY VOLTAGE

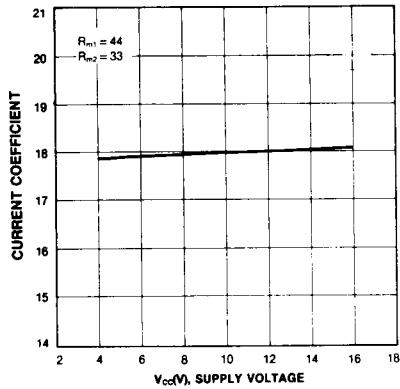

REFERENCE VOLTAGE-MOTOR CURRENT

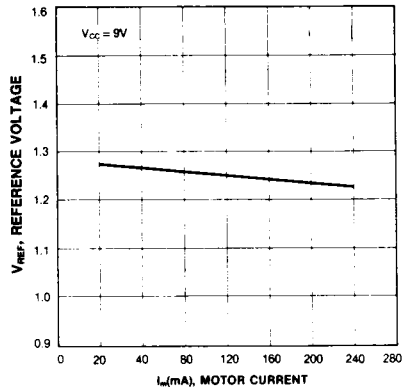

CURRENT COEFFICIENT-AMBIENT TEMPERATURE

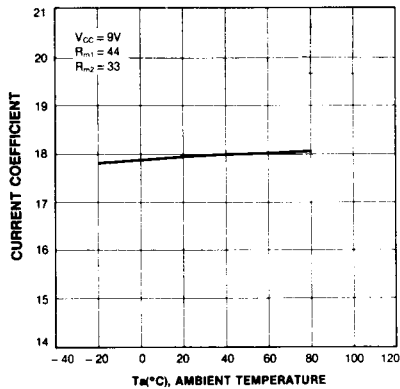

REFERENCE VOLTAGE-AMBIENT TEMPERATURE

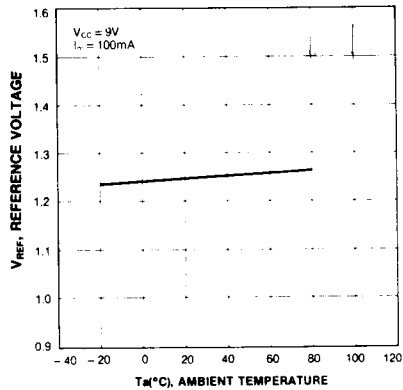

(APPLICATION CHARACTERISTICS)

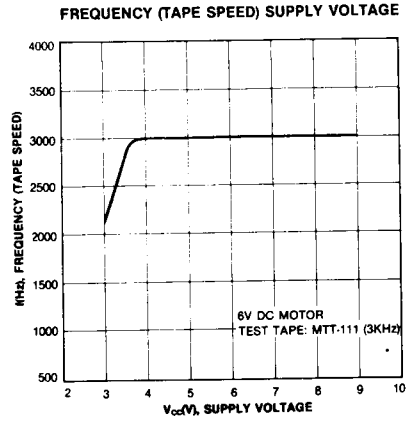
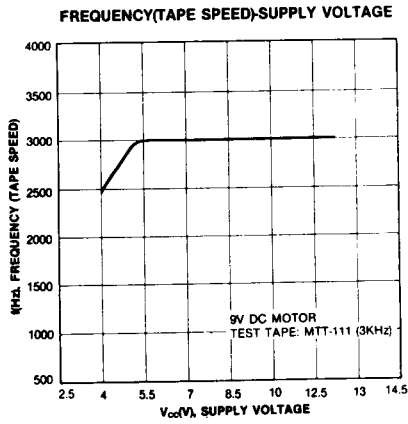

APPLICATION CIRCUIT

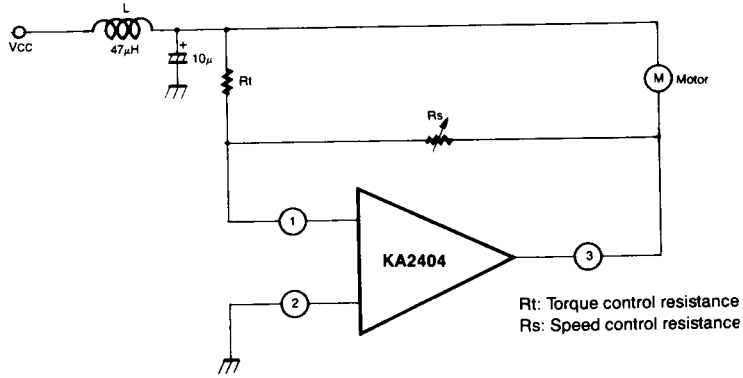

Fig. 5



LittleDiode supplies new, hard to find or obsolete electronic components and semiconductors all over the world.

With over two million different components listed you are sure to find the part you need.

Feel free to visit us today at our online store:

LittleDiode.com

Looking forward to providing you with the best possible service.